



SCHWERT

CHIRURGIE

INSTRUMENTE

SURGERY

INSTRUMENTS

SEIT / SINCE 1896

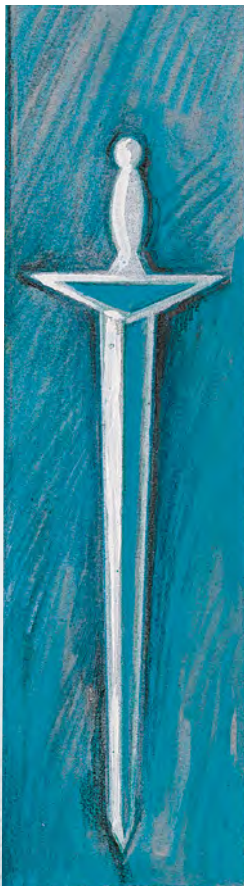

SCHWERT

SWORD · ESPADA
EPEE · SPADA





SCHWERT
SWORD - ESPADA
EPEE - SPADA



Sehr geehrter Kunde

Die EU-Verordnung für Medizinprodukte (Medical Device Regulation) bringt viele neue Anforderungen mit sich. Eine wichtige neue Anforderung sind die Angaben auf dem Etikett der Verpackung.

Aus diesem Grund haben wir unser Etikett auf den neusten Stand gebracht und möchten es auf diesem Weg kurz vorstellen.

Dear Customer

The EU Regulation on Medical Devices (Medical Device Regulation) leads to many new requirements.

An important new requirement is the information on the packaging label.

For this reason, we have updated our label and would like to introduce it to you briefly.

A. Schweickhardt GmbH & Co. KG
Tuttlingerstraße 12
D -78606 Seitingen / Germany

MD CE

REF 617-21
P-Lux periotome, flexible, curved tip
16,8cm

QTY 1

LOT 368559 AEES Scan QR-CODE for available Application Guidance or send a request by e-mail to contact@schwert.com !
==>

HIBC 2020-05-28

+E896617211/\$368559AEESJ

Dok.-Nr. 070509001L / Rev. 21.04.2021

- MD** Medizinprodukt / Medical device
- CE-Zeichen** / CE marking
- Hersteller / Manufacturer
- QTY X** Menge / Quantity
- REF** Artikel-Nr. / Article no. + Artikel-Bezeichnung / Art. description
- Symbole / Symbols
- LOT** LOT Nr. / LOT no.
- HIBC** HIBC Barcode + HR Code
- Herstellungsdatum / Date of manufacture
- *QR-Code

*Direktzugriff auf alle produktspezifischen Anwenderinformationen über:
*Direct access to all product-specific user information on:

schwert.com



Inhaltsübersicht
Table of Contents
Sommaire
Sumario



Diagnostik
Diagnostic
Diagnostic
Diagnóstico

Seite, Page
Page, Página

9 - 15

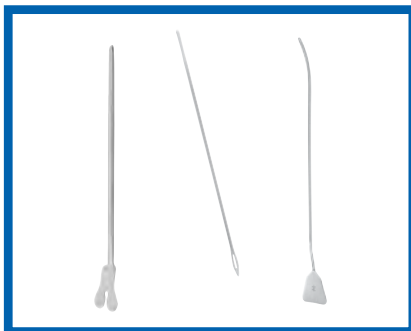

Sonden, Watteträger, Spatel, Veneninstrumente
Probes, Applicators, Spatulas, Vein Instruments
Sondes, Porte-cotons, Spatules, Instruments à varices
Sondas, Porta-algodones, Espatulas, Instrumentes para varices

16 - 20



Splitterzangen
Splinter Forceps
Pinces à echardes
Pinzas para espinas

21 - 22



Pinzetten
Forceps
Pinces
Pinzas

23 - 40

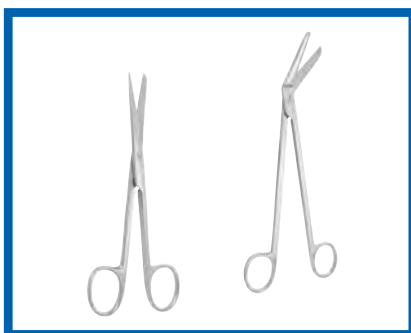

Scheren, Supercut-Scheren
Scissors, Supercut Scissors
Ciseaux, Ciseaux Supercut
Tijeras, Tijeras Supercut

41 - 61



SCHWERT
SWORD · ESPADA
EPEE · SPADA



SCHWERT
SWORD - ESPADA
EPEE - SPADA

Inhaltsübersicht
Table of Contents
Sommaire
Sumario

Seite, Page
Page, Página



Instrumente für Verband und Gips
Bandage and Plaster Instruments
Instruments pour pansements et plâtre
Instrumentos para vendajes y yeso

62 - 71



Naht
Suture
Suture
Sutura

72 - 94



Instrumente mit Hartmetalleinlagen
Instruments with Tungsten Carbide Inserts
Instruments avec mors en carbure de tungstène
Instrumentes con placas de carburo tungsteno

95 - 114

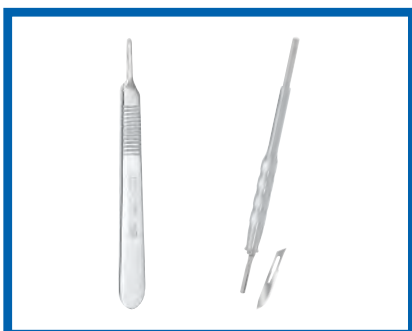

Messer, Skalpelle
Knives, Scalpels
Couteaux, Bistouris
Cuchillos, Bisturías

115 - 120



Verschiedene Klemmen
Miscellaneous Forceps
Pinces diverses
Pinzas diversas

121 - 146

Inhaltsübersicht
Table of Contents
Sommaire
Sumario



Knochenchirurgie-Instrumente
Bone Surgery Instruments
Instrumentation pour la Chirurgie Osseuse
Instrumental para la cirugía ósea

Seite, Page
Page, Página

147 - 209



Wundhaken, Wundsperrer
Retractors
Ecarteurs
Separadores

210 - 260



Thorax- und Gefäß-Chirurgie
Thoracic and Vascular Surgery
Chirurgie Thoracique et Vasculaire
Cirugía Torácica y Vascolar

261 - 277

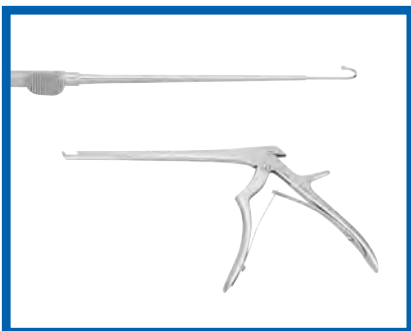

Kopf und Wirbelsäule
Head and Spine
Tête et Colonne Vertébrale
Cabeza y Columna Vertebral

278 - 304

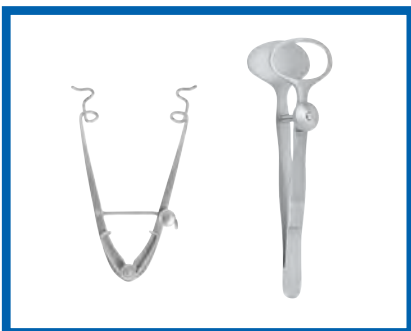

Augeninstrumente
Ophthalmological Instruments
Instruments ophtalmologiques
Instrumentes para oftalmologia

305 - 328



SCHWERT
SWORD · ESPADA
EPEE · SPADA



SCHWERT
SWORD - ESPADA
EPEE - SPADA

**Inhaltsübersicht
Table of Contents
Sommaire
Sumario**



**Mikrochirurgie
Microsurgery
Microchirurgie
Microcirugía**

Seite, Page
Page, Página

329 - 334

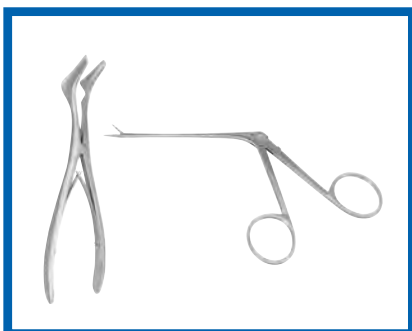

**HNO-Instrumente
ENT-Instruments
Instruments ORL
Instrumental ORL**

335 - 384



**Narkose
Anaesthesia
Anesthésie
Anestesia**

385 - 395

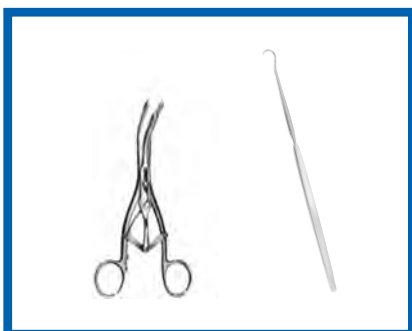

**Tracheotomie
Tracheotomy
Trachéotomie
Traqueotomía**

396 - 399

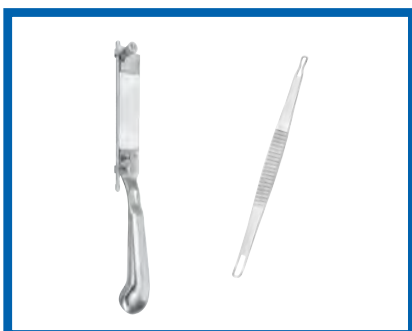

**Dermatologie
Dermatology
Dermatologie
Dermatologia**

400 - 404

**Inhaltsübersicht
Table of Contents
Sommaire
Sumario**



**Magen und Darm
Stomach, Intestine
Estomac, Intestin
Estómago, Intestina**

Seite, Page
Page, Página

405 - 413



**Galle, Niere, Urologie
Bile, Kidney, Urology
Bile, Rein, Urologie
Vesícula biliar, Riñon, Urología**

414 - 425



**Rektum Instrumente
Rectal Instruments
Instruments Rectaux
Instrumentes Rectales**

426 - 437



**Gynäkologie, Geburtshilfe
Gynecology, Obstetrics
Gynécologie, Accouchement
Ginecología, Obstetricia**

438 - 478



**Verschiedene Nagelinstrumente
Miscellaneous Nail Instruments
Instruments divers pour les ongles
Instrumentes diverses para las uñas**

479 - 482



SCHWERT
SWORD · ESPADA
EPEE · SPADA



SCHWERT
SWORD · ESPADA
EPEE · SPADA

Inhaltsübersicht Table of Contents Sommaire Sumario

i

Alle **Artikelnummern** finden Sie im Index ab Seite 515.

All **article numbers** can be found in the index from page 515.

Vous trouverez tous les **numéros d'article** dans l'index à partir de la page 515.

Todos los números de los **artículos figuran** en el índice a partir de la página 515.

9 - 15

Diagnostik / Diagnostic

Diagnostic / Diagnóstico

16 - 20

Sonden, Watteträger, Spatel, Veneninstrumente / Probes, Applicators, Spatulas, Vein Instruments

Sondes, Porte-cotons, Spatules, Instruments à vârices / Sondas, Porta-algodones, Espatulas, Instrumentes para varices

21 - 22

Splitterzangen / Splinter Forceps

Pincas à echardes / Pinzas para espinas

23 - 40

Pinzetten / Forceps

Pincas / Pinzas

41 - 61

Scheren, Supercut-Scheren / Scissors, Supercut Scissors

Ciseaux, Ciseaux Supercut / Tijeras, Tijeras Supercut

62 - 71

Instrumente für Verband und Gips / Bandage and Plaster Instruments

Instruments pour pansements et plâtre / Instrumentes para vendajes y yeso

72 - 94

Naht / Suture

Suture / Sutura

95 - 114

Instrumente mit Hartmetalleinlagen / Instruments with Tungsten Carbide Inserts

Instruments avec mors en carbure de tungstène / Instrumentes con placas de carburo tungsteno

115 - 120

Messer, Skalpell / Knives, Scalpels

Couteaux, Bistouris / Cuchillos, Bisturías

121 - 146

Verschiedene Klemmen / Miscellaneous Forceps

Pincas diverses / Pinzas diversas

147 - 209

Knochenchirurgie-Instrumente / Bone Surgery Instruments

Instrumentation pour la Chirurgie Osseuse / Instrumental para la cirugía ósea

210 - 260

Wundhaken, Wundsperrer / Retractors

Ecarteurs / Separadores

261 - 277

Thorax- und Gefäß-Chirurgie / Thoracic and Vascular Surgery

Chirurgie Thoracique et Vasculaire / Cirugía Torácica y Vascular

278 - 304

Kopf und Wirbelsäule / Head and Spine

Tête et Colonne Vertébrale / Cabeza y Columna Vertebral

305 - 328

Augeninstrumente / Ophthalmological Instruments

Instruments ophtalmologiques / Instrumentes para oftalmología

329 - 334

Mikrochirurgie / Microsurgery

Microchirurgie / Microcirugía

335 - 384

HNO-Instrumente / ENT-Instruments

Instruments ORL / Instrumental ORL

385 - 395

Narkose / Anaesthesia

Anesthésie / Anestesia

396 - 399

Tracheotomie / Tracheotomy

Trachéotomie / Traqueotomía

400 - 404

Dermatologie / Dermatology

Dermatologie / Dermatología

405 - 413

Magen und Darm / Stomach, Intestine

Estomac, Intestin / Estómago, Intestina

414 - 424

Galle, Niere, Urologie / Bile, Kidney, Urology

Bile, Rein, Urologie / Vesícula biliar, Riñon, Urología

425 - 437

Rektum Instrumente / Rectal Instruments

Instruments Rectaux / Instrumentes Rectales

438 - 478

Gynäkologie, Geburtshilfe / Gynecology, Obstetrics

Gynécologie, Accouchement / Ginecología, Obstetricia

479 - 482

Verschiedene Nagelinstrumente / Miscellaneous Nail Instruments

Instruments divers pour les ongles / Instrumentes diverses para las uñas



SCHWERT
SWORD · ESPADA
EPEE · SPADA

Diagnostik Diagnostic Diagnostic Diagnóstico





Kehlkopfspiegel Laryngeal Mirrors Miroirs laryngiens Espejos laringeos

SCHWERT
SWORD · ESPADA
EPEE · SPADA

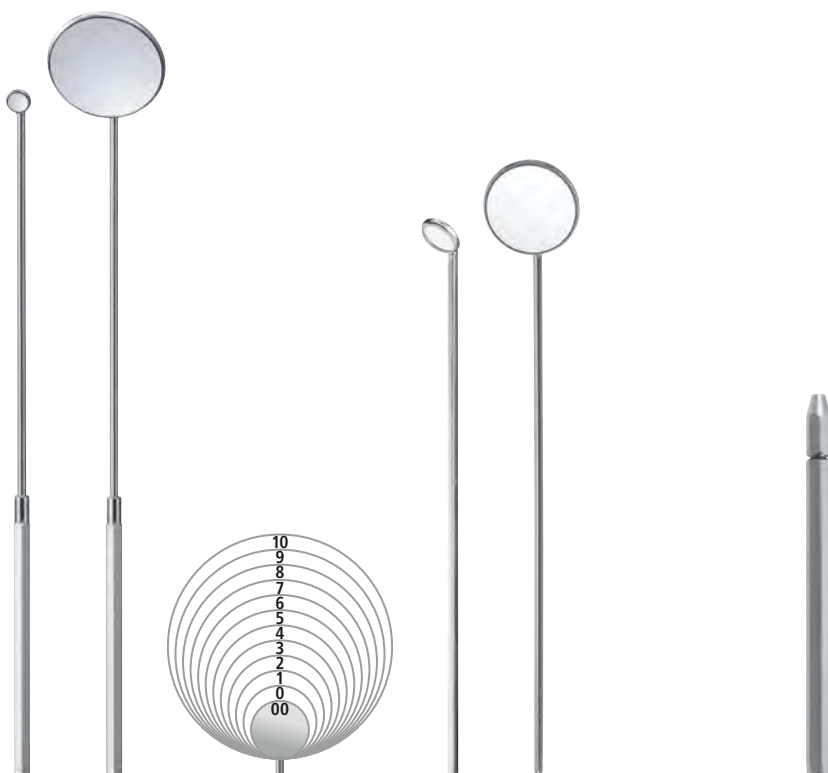

22508-30	Fig. 000	=	6 mm Ø	22505-30
22508-20	Fig. 00	=	8 mm Ø	22505-20
22508-0	Fig. 0	=	10 mm Ø	22505-0
22508-1	Fig. 1	=	12 mm Ø	22505-1
22508-2	Fig. 2	=	14 mm Ø	22505-2
22508-3	Fig. 3	=	16 mm Ø	22505-3
22508-4	Fig. 4	=	18 mm Ø	22505-4
22508-5	Fig. 5	=	20 mm Ø	22505-5
22508-6	Fig. 6	=	22 mm Ø	22505-6
22508-7	Fig. 7	=	24 mm Ø	22505-7
22508-8	Fig. 8	=	26 mm Ø	22505-8
22508-9	Fig. 9	=	28 mm Ø	22505-9
22508-10	Fig. 10	=	30 mm Ø	22505-10

22500

10,0 cm/4"

Metallgriff für Kehlkopfspiegel
Metal handle for laryngeal mirrors
Manche pour miroirs laryngiens
Mango metalico para espejos laringeos

Perkussionshämmer
Percussion Hammers
Marteaux - percuteurs
Martillos de percusión



SCHWERT
SWORD · ESPADA
EPEE · SPADA



Babinsky

10921

22 cm/8¾"

Babinsky

10921-1

Gummi allein
Rubber only
Gommeseul
Goma suelta



Taylor

10912

20 cm/8"



Berliner

10908

20 cm/8"



Traube

10900

17 cm/6¾"



Troemner

10935

24 cm/9½"

Perkussionshämmer
Percussion Hammers
Marteaux - percuteurs
Martillos de percusión

Prüf- und Messinstrumente
Examination and Measuring Instruments
Instruments pour examiner et mesurer
Instrumentes para examenes y medidas

Ohrspekula
Ear Specula
Speculums auriculaires
Especulos auriculares



Buck
10926
 18 cm/7"



Déjerine
10930
 20 cm/8"

ohne Nadel
 without needle
 sans aiguille
 sin aguja



Déjerine
10931
 21 cm/8¼"

mit Nadel
 with needle
 avec aiguille
 con aguja



Rabiner
10937
 23 cm/9"



Metall-Messstab mit Millimetereinteilung. Nur zur Vergleichsmessung.
 Metal Rule graduated in millimeters and inches. Only for comparison measurement.
 Règle en metal divise en centimetres et pouces. Pour une mesure comparative uniquement.
 Regla metrica de metal graduada en milimetros y pulgadas. Sólo a efectos comparativos.

- 10854-15** 15,0 cm/6"
- 10854-20** 20,0 cm/8"
- 10854-30** 30,0 cm/12"
- 10854-50** 50,0 cm/20"



10856-15 15,0 cm/6"



Hartmann

Ohrspekula
 Ear Specula
 Speculum auriculaire
 Especulo auricular



Fig. 0

20124
 3,0 mm Ø



Fig. 1

20123-11
 4,0 mm Ø



Fig. 2

20123-12
 5,0 mm Ø



Fig. 3

20123-13
 6,0 mm Ø



Fig. 4

20123-14
 7,5 mm Ø

20124-3

Satz, set, jeu, juego
 Fig. 0, 1, 2

20123-3

Satz, set, jeu, juego
 Fig. 2, 3, 4

Stimmgabeln
Tuning forks
Diapasóns
Diapasónes



SCHWERT
SWORD · ESPADA
EPEE · SPADA



Hartmann
c 128
20154-C



Hartmann
c¹ 256
20154-C1



Hartmann
c² 512
20154-C2



Hartmann
c³ 1024
20154-C3



Hartmann
c⁴ 2048
20154-C4



Hartmann
c⁵ 4096
20154-C5



Hartmann
c 64
20158-C64



Hartmann
c 128
20158-C128



Hartmann
c¹ 256
20158-C1



Hartmann
mit Fuß, with foot
avec pied, con pie
c¹ 256
20155-C1



SCHWERT
SWORD · ESPADA
EPEE · SPADA

**Stimmgabeln
Tuning forks
Diapasons
Diapasónes**



Lucae
c 128
20160-C



Lucae
c¹ 256
20160-C1



Lucae
c² 512
20160-C2



Lucae
c³ 1024
20160-C3



Lucae
c⁴ 2048
20160-C4



Lucae
c⁵ 4096
20160-C5



Lucae
c 128
20161-C

Stimmgabeln
Tuning forks
Diapasons
Diapasónes



SCHWERT
SWORD · ESPADA
EPEE · SPADA



20175-1

Satz zu 6 Hartmann Stimmgabeln im Etui
Set of 6 Hartmann tuning forks in a case
Jeu de 6 Hartmann diapasons dans un étui
Juego de 6 Hartmann diapasones en estuche
(20154-C2, 20154-C3, 20154-C4, 20154-C5,
20158-C128, 20158-C1)

20178

Satz zu 8 Hartmann Stimmgabeln im Etui
Set of 8 Hartmann tuning forks in a case
Jeu de 8 Hartmann diapasons dans un étui
Juego de 8 Hartmann diapasones en estuche
(20154-C2, 20154-C3, 20154-C4, 20154-C5,
20158-C64, 20158-C128, 20158-C1, 20162-C1)





SCHWERT
SWORD · ESPADA
EPEE · SPADA

Sonden, Watteträger, Spatel, Veneninstrumente
Probes, Applicators, Spatulas, Vein Instruments
Sondes, Porte-cotons, Spatules, Instruments à varices
Sondas, Porta-algodones, Espatulas, Instrumentes para varices

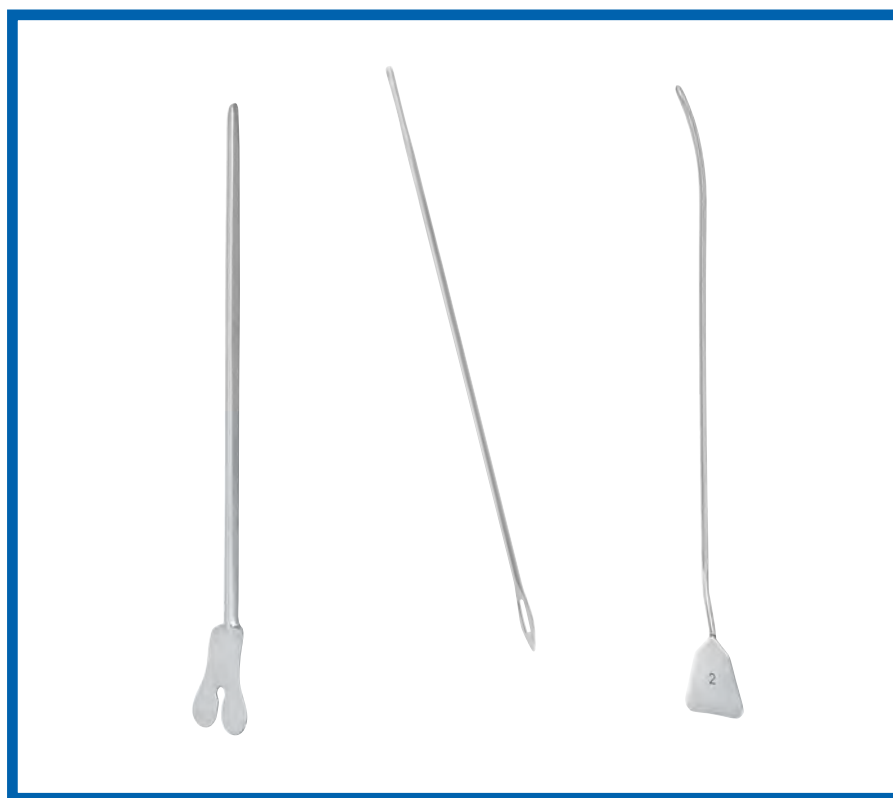

Sonden
Probes and Directors
Stylets et Sandes
Estiletos y Sondas



SCHWERT
SWORD · ESPADA
EPEE · SPADA

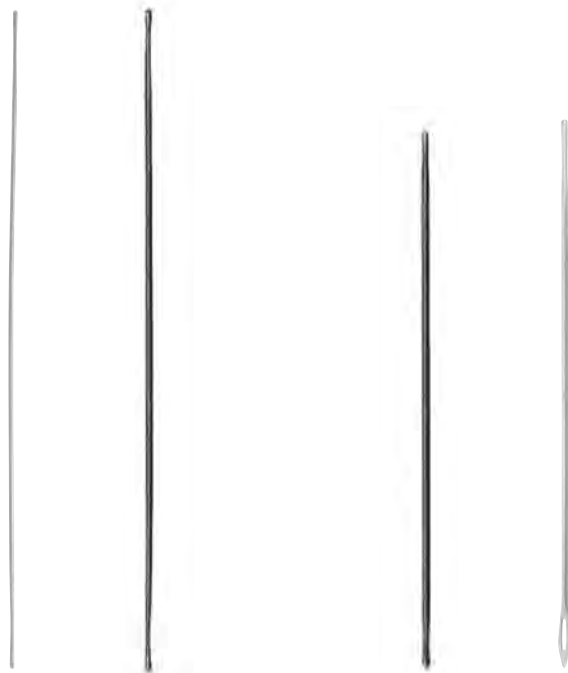

cm	inch	1,0 mm Ø	1,5 mm Ø	2,0 mm Ø	2,0 mm Ø
11,5	4½	11078-11		11080-11	11085-11
13,0	5	11078-13		11080-13	11085-13
14,5	5½	11078-14	11079-14	11080-14	11085-14
16,0	6¼	11078-16	11079-16	11080-16	11085-16
18,0	7	11078-18	11079-18	11080-18	11085-18
20,0	8	11078-20	11079-20	11080-20	11085-20
25,0	10			11080-25	11085-25



cm	inch			Doyen	Nelaton
11,5	4½	11090-11	11104-11		
13,0	5	11090-13	11104-13	11106-13	
14,0	5½	11090-14	11104-14	11106-14	11110-14
16,0	6¼	11090-16	11104-16	11106-16	11112-16
18,0	7		11104-18		
20,0	8		11104-20		



SCHWERT
SWORD · ESPADA
EPEE · SPADA

Sonden Probes and Directors Stylets et Sandes Estiletos y Sondas



Lockhart-Mummery
16,5 cm/6½"

Fig. 1
11120-1

Fistelsonden
Fistula probes
Sondes pour fistules
Sondas para fistulas

Fig. 2
11120-2

Fig. 3
11120-3

Fig. 4
11120-4



Watson-Cheyne

11115-13 13,0 cm/5"

11115-18 18,0 cm/7¼"

**Pflasterspatel
Plaster Spatula
Spatules
Espátulas**

**Watteträger
Cotton Applicators
Porte-cotons
Porta-algodones**



Pflasterspatel
Plaster Spatula
Spatules
Espátulas

11160-13 13,0 cm/5"

11160-14 14,5 cm/5½"



Farrell
(Lathbury)

	cm	inch	mm Ø
20202-12	12,0	4¾	0,9
20203-14	14,0	5½	1,0
20202-14	14,0	5½	0,9
20204-14	14,0	5½	1,2
20204-16	18,0	6½	1,1
20204-18	18,0	7	1,2
20208-18	18,0	7	1,5
20209-18	18,0	7	1,8



Jobson-Horne

20220-18

18,0 cm/7"



Uckermann

20210-16

16,0 cm/6¼"



SCHWERT
SWORD · ESPADA
EPEE · SPADA



SCHWERT
SWORD · ESPADA
EPEE · SPADA

Krampfader-Besteck Varicose Vein Probe Set Trousse à varices Juego para várices



Nabatoff

11185

135x100x25 mm

Satz komplett

Set complete

Jeu complet

Juego completo

11185-1

Metalletui allein

Metal case only

Boîte metal seule

Estuche de metal suelto

11185-2



11185-20



11185-8

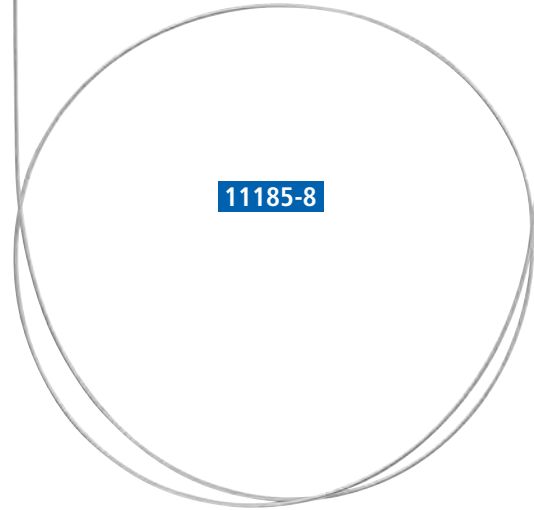

1:1



11185-3

Ø 3,0 mm



11185-6

Ø 6,0 mm



11185-9

Ø 9,0 mm



11185-12

Ø 12,0 mm



11185-15

Ø 15,0 mm



SCHWERT
SWORD · ESPADA
EPEE · SPADA

Splitterzangen

Splinter Forceps

Pinces à echardes

Pinzas para espinas





Splitterzangen
Splinter Forceps
Pinces à échardes
Pinzas para espinas

SCHWERT
SWORD · ESPADA
EPEE · SPADA



Peet

11275

11,5 cm/4½"



Arthur

11270

13,5 cm/5½"
gerade, straight,
droite, recta

11270-5

gebogen, curved,
courbe, curvas



Stieglitz

11260-14

13,5 cm/5½"
gerade, straight,
droite, recta

11261-14

gebogen, curved,
courbe, curvas



Ralk

15,0 cm/6"



11272

gerade
straight
droite
recta



11272-5

gebogen
curved
courbe
curva



SCHWERT
SWORD · ESPADA
EPEE · SPADA

Pinzetten
Forceps
Pinces
Pinzas





SCHWERT
SWORD · ESPADA
EPEE · SPADA

Schweizer Pinzetten, extra fein
Fine Swiss Tweezers
Brucelles suisses
Pinzas suizas



0,3 mm

11412-12



0,3 mm

11413-2



0,2 mm

11413-3



0,2 mm

11412-11



0,15 mm

11413-5



0,2 mm

11413-6



0,25 mm

11411



Anatomische Pinzetten
Dressing Forceps
Pinces à dissection
Pinzas de disección



SCHWERT
 SWORD · ESPADA
 EPEE · SPADA



Standard

11305-10	10,5 cm/4¼"
11305-11	11,5 cm/4½"
11305-13	13,0 cm/5"
11305-14	14,5 cm/5½"
11305-16	16,0 cm/6¼"
11305-18	18,0 cm/7"
11305-20	20,0 cm/8"
11305-25	25,0 cm/10"
11305-30	30,0 cm/12"



Standard
 gebogen, curved
 courbe, curvas

11306-10	10,5 cm/4¼"
11306-11	11,5 cm/4½"
11306-13	13,0 cm/5"
11306-14	14,5 cm/5½"
11306-16	16,0 cm/6¼"
11306-18	18,0 cm/7"
11306-20	20,0 cm/8"
11306-25	25,0 cm/10"



schmal, narrow
 étroite, estrechas

11300-11	11,5 cm/4½"
11300-13	13,0 cm/5"
11300-14	14,5 cm/5½"
11300-16	16,0 cm/6¼"
11300-18	18,0 cm/7"
11300-20	20,0 cm/8"
11300-25	25,0 cm/10"
11300-30	30,0 cm/12"



schmal, narrow
 étroite, estrechas

11301-11	11,5 cm/4½"
11301-13	13,0 cm/5"
11301-14	14,5 cm/5½"
11301-16	16,0 cm/6¼"
11301-18	18,0 cm/7"
11301-20	20,0 cm/8"
11301-25	25,0 cm/10"
11301-30	30,0 cm/12"



fein, delicate
 fine, finas

11302-13	13,0 cm/5"
11302-14	14,5 cm/5½"



Schwedisches Modell
Swedish pattern
Modele suedois
Modelo sueco

11312-13	13,0 cm/5"
11312-15	15,0 cm/6"
11312-17	17,0 cm/6¾"



SCHWERT
SWORD · ESPADA
EPEE · SPADA

Anatomische Pinzetten Dressing Forceps Pincès à dissection Pinzas de disección



USA-Mod. Standard

11325-12	12,0 cm/4¾"
11325-13	13,0 cm/5"
11325-14	14,5 cm/5½"
11325-15	15,5 cm/6"
11325-18	18,0 cm/7"
11325-21	21,0 cm/8¼"
11325-25	25,0 cm/10"
11325-31	31,0 cm/12¼"



USA-Mod.

schmal, narrow
étroite, estrechas

11326-12	11,5 cm/4½"
11326-13	13,0 cm/5"
11326-14	14,5 cm/5½"
11326-15	15,5 cm/6"



engl. Mod.

11320-13	13,0 cm/5"
11320-14	14,5 cm/5½"
11320-15	15,5 cm/6"



Semken

11340-13	13,0 cm/5"
11340-15	15,0 cm/6"



Adson

Micro 0,8 mm	
11405-12	12,0 cm/4¾"
1,2 mm	
11400	12,0 cm/4¾"



Mc Indoe

11342	15,0 cm/6"
--------------	------------

Anatomische Pinzetten
Dressing Forceps
Pinces à dissection
Pinzas de disección



SCHWERT
 SWORD · ESPADA
 EPEE · SPADA



Potts-Smith

- 11450-18** 18,0 cm/7"
- 11450-20** 21,0 cm/8¼"
- 11450-25** 25,0 cm/10"



Potts-Smith
 gebogen, curved
 courbe, curvas

- 11449-18** 18,0 cm/7"
- 11449-21** 21,0 cm/8¼"
- 11449-25** 25,0 cm/10"



Gerald

- 11444** 18,0 cm/7"



Gerald
 gebogen, curved
 courbe, curvas

- 11444-5** 18,0 cm/7"



Taylor

- 11439** 17,5 cm/7"



Taylor
 gebogen, curved
 courbe, curvas

- 11439-5** 17,5 cm/7"



Taylor

- 11440** 17,5 cm/7"



Taylor
 gebogen, curved
 courbe, curvas

- 11440-5** 17,5 cm/7"



SCHWERT
SWORD · ESPADA
EPEE · SPADA

Anatomische Pinzetten Dressing Forceps Pincès à dissection Pinzas de disección



Waugh

11447-15 15,0 cm/6"

11447-20 20,0 cm/8"



Brophy

11448-1 20,0 cm/8"



Brophy
gebogen, curved
courbe, curvas

11448-5 20,0 cm/8"



Cushing

11449 17,5 cm/7"



Cushing
gebogen, curved
courbe, curvas

11449-5 17,5 cm/7"

Chirurgische Pinzetten
Tissue Forceps
Pincés à dissection à griffes
Pinzas de disección con dientes



SCHWERT
SWORD · ESPADA
EPEE · SPADA



1:2

11361-10	10,5 cm/4¼"
11361-11	11,5 cm/4½"
11361-13	13,0 cm/5"
11361-14	14,5 cm/5½"
11361-16	16,0 cm/6¼"
11361-18	18,0 cm/7"
11361-20	20,0 cm/8"
11361-25	25,0 cm/10"
11361-30	30,0 cm/12"



2:3

11362-11	11,5 cm/4½"
11362-13	13,0 cm/5"
11362-14	14,5 cm/5½"
11362-16	16,0 cm/6¼"
11362-18	18,0 cm/7"
11362-20	20,0 cm/8"
11362-25	25,0 cm/10"
11362-30	30,0 cm/12"



3:4

11363-13	13,0 cm/5"
11363-14	14,5 cm/5½"
11363-16	16,0 cm/6¼"



4:5

11364-13	13,0 cm/5"
11364-14	14,5 cm/5½"
11364-16	16,0 cm/6¼"



1:2
schmal, narrow
étroite, estrechas

11350-13	13,0 cm/5"
11350-14	14,5 cm/5½"
11350-16	16,0 cm/6¼"
11350-20	20,0 cm/8"



USA-Mod. 1:2

11375-12	12,0 cm/4¾"
11375-13	13,0 cm/5"
11375-14	14,5 cm/5½"
11375-15	15,5 cm/6"
11375-18	18,0 cm/7"
11375-21	21,0 cm/8¼"
11375-25	25,0 cm/10"
11375-31	31,0 cm/12¼"



USA-Mod. 2:3

11376-12	12,0 cm/4¾"
11376-13	13,0 cm/5"
11376-14	14,5 cm/5½"
11376-15	15,5 cm/6"
11376-18	18,0 cm/7"
11376-21	21,0 cm/8¼"
11376-25	25,0 cm/10"
11376-31	31,0 cm/12¼"



SCHWERT
SWORD · ESPADA
EPEE · SPADA

Chirurgische Pinzetten
Tissue Forceps
Pinces à dissection à griffes
Pinzas de disección con dientes



USA-Mod. Standard
fein, delicate
fine, finas

11377-13	13,0 cm/5"
11377-14	14,5 cm/5½"
11377-15	15,5 cm/6"



Adlerkreuz

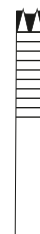

2:3

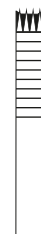

4:5

15,0 cm/6"	11434-15	11435-15
20,0 cm/8"	11434-20	11435-20
25,0 cm/10"	11434-25	11435-25



Semken

11390-13	12,5 cm/5"
11390-15	15,0 cm/6"



Adson

1,2 mm	
12,0 cm/4½"	11402
15,0 cm/6"	11402-15

Micro 0,8 mm 1,2 mm	
12,0 cm/4½"	11406-12
15,0 cm/6"	11406-15



1,2 mm	
12,0 cm/4½"	11403



Chirurgische Pinzetten
Tissue Forceps
Pincés à dissection à griffes
Pinzas de disección con dientes



SCHWERT
SWORD · ESPADA
EPEE · SPADA



Adson Brown

9x9

11408

12,0 cm/4½"



Gillies

11381

15,0 cm/6"



Gerald

17,5 cm/7"

11446

1,4 mm

11446-1

0,9 mm



Gerald

gebogen, curved
courbe, curvas

11446-5

17,5 cm/7"



SCHWERT
SWORD · ESPADA
EPEE · SPADA

Chirurgische Pinzetten
Tissue Forceps
Pinces à dissection à griffes
Pinzas de disección con dientes



Tayler

11442 17,5 cm/7"



Tayler
gebogen, curved
courbe, curvas

11442-5 17,5 cm/7"



Cushing

11447 17,5 cm/7"



Cushing
gebogen, curved
courbe, curvas

11447-5 17,5 cm/7"



Brophy

11448 20,0 cm/8"



Brophy
gebogen, curved
courbe, curvas

11448-6 20,0 cm/8"



Waugh

11449-15 15,0 cm/6"

11449-20 20,0 cm/8"

Chirurgische Pinzetten
Tissue Forceps
Pincès à dissection à griffes
Pinzas de disección con dientes



SCHWERT
SWORD · ESPADA
EPEE · SPADA



Taylor

11463 17,5 cm/7"



Taylor

11464 17,5 cm/7"



Potts-Smith

11452-18 18,0 cm/7"
11452-20 21,0 cm/8¼"
11452-25 25,0 cm/10"



Potts-Smith
gebogen, curved
courbe, curvas

11452-518 18,0 cm/7"
11452-521 21,0 cm/8¼"
11452-525 25,0 cm/10"



Lane 1:2

11421-14 14,5 cm/5½"
11421-18 18,0 cm/7"



Lane 2:3

11422-14 14,5 cm/5½"
11422-18 18,0 cm/7"



Bonney 1:2

11430-17 18,0 cm/7"



Bonney 2:3

11431-18 18,0 cm/7"



SCHWERT
SWORD · ESPADA
EPEE · SPADA

Thorax-Pinzetten
Lung grasping Forceps
Pinces pour saisir le poumon
Pinzas para coger el pulmón



Mod. Russ.

- 11410-15** 15,0 cm/6"
- 11410-20** 20,0 cm/8"
- 11410-25** 25,0 cm/10"



Singley-Tuttle

- 11416-23** 23,0 cm/9"



Nelson

- 11417-23** 23,0 cm/9"



Mod. Mayo-Russ

- 11414-23** 23,0 cm/9"

Atrauma-Pinzetten
Atrauma Forceps
Pinces atraumatiques
Pinzas atraumáticas



SCHWERT
 SWORD · ESPADA
 EPEE · SPADA



De Bakey
 gerade, straight,
 droite, rectas

	1,5 mm	2,0 mm	2,7 mm	3,5 mm
16,0 cm/6¼"	17228-15	17248-15	17246-15	17250-15
20,0 cm/8"	17228-20	17248-20	17246-20	17250-20
24,0 cm/9½"	17228-24	17248-24	17246-24	17250-24
30,0 cm/12"	17228-30	17248-30	17246-30	17250-30



De Bakey
 abgewinkelt, angular
 angulaire, angulares

	2,0 mm
16,0 cm/6¼"	17249-15
20,0 cm/8"	17249-20
24,0 cm/9½"	17249-24
30,0 cm/12"	17249-30



SCHWERT
SWORD · ESPADA
EPEE · SPADA

Anatomische und Chirurgische Pinzetten, fein
Dressing and Tissue Forceps, delicate
Pinces à dissection et à griffes, fines
Pinzas de disección, finas



19600 10,5 cm/4½"



19602 10,5 cm/4½"



19603 10,5 cm/4½"



19604 10,5 cm/4½"



19605 10,5 cm/4½"



19606 10,5 cm/4½"

Splitterpinzetten
Splinter Forceps
Pinces à échardes
Pinzas para espinas



SCHWERT
 SWORD · ESPADA
 EPEE · SPADA



glatt, smooth
 lisse, lisas
 ohne Stift, without pin
 sans cheville, sin perno

11250-8	8,0 cm/3¼"
11250-9	9,0 cm/3½"
11250-10	10,5 cm/4¼"
11250-11	11,5 cm/4½"
11250-12	12,5 cm/5"

11251-8	8,0 cm/3¼"
11251-9	9,0 cm/3½"
11251-10	10,5 cm/4¼"
11251-11	11,5 cm/4½"
11251-12	12,5 cm/5"



gerieft, serrated
 striée, estriadas
 ohne Stift, without pin
 sans cheville, sin perno

11252-8	8,0 cm/3¼"
11252-9	9,0 cm/3½"
11252-10	10,5 cm/4¼"
11252-11	11,5 cm/4½"
11252-12	12,5 cm/5"

11253-8	8,0 cm/3¼"
11253-9	9,0 cm/3½"
11253-10	10,5 cm/4¼"
11253-11	11,5 cm/4½"
11253-12	12,5 cm/5"



glatt, smooth
 lisse, lisas
 ohne Stift, without pin
 sans cheville, sin perno

11254-8	8,0 cm/3¼"
11254-9	9,0 cm/3½"
11254-10	10,5 cm/4¼"
11254-11	11,5 cm/4½"
11254-12	12,5 cm/5"

11255-8	8,0 cm/3¼"
11255-9	9,0 cm/3½"
11255-10	10,5 cm/4¼"
11255-11	11,5 cm/4½"
11255-12	12,5 cm/5"



gerieft, serrated
 striée, estriadas
 ohne Stift, without pin
 sans cheville, sin perno

11245-8	8,0 cm/3¼"
11245-9	9,0 cm/3½"
11245-10	10,5 cm/4¼"
11245-11	11,5 cm/4½"
11245-12	12,5 cm/5"

11246-8	8,0 cm/3¼"
11246-9	9,0 cm/3½"
11246-10	10,5 cm/4¼"
11246-11	11,5 cm/4½"
11246-12	12,5 cm/5"





Splitterpinzetten
Splinter Forceps
Pinces à échardes
Pinzas para espinas

SCHWERT
SWORD · ESPADA
EPEE · SPADA



Feilchenfeld

- 11240-8** 7,5 cm/3"
- 11240-9** 9,0 cm/3½"
- 11240-11** 11,5 cm/4½"



Hunter

- 11248** 10,5 cm/4¼"



Hunter

- 11249** 10,5 cm/4¼"



Walter-Carmalt

- 11247** 10,5 cm/4¼"



Walter-Carmalt

- 11247-5** 10,5 cm/4¼"

Tumorpinzetten
Tumor Forceps
Pinces à tumeurs
Pinzas para tumores

Mikro-Knüpfpinzetten
Micro suture tying Forceps
Pinces à suture
Pinzas para poner ligaduras



SCHWERT
 SWORD · ESPADA
 EPEE · SPADA



Yasargil
 22,0 cm/8¾"
 glatt, smooth
 lisse, lisas

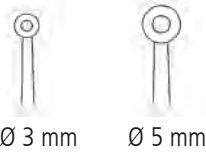

Ø 3 mm

Ø 5 mm

18624-3

18624-5



Yasargil
 22,0 cm/8¾"
 gerieft, serrated
 striée, estriadas

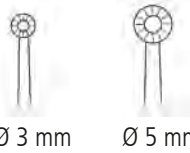

Ø 3 mm

Ø 5 mm

18625-3

18625-5



Heifetz
 22,0 cm/8¾"
 gerieft, serrated
 striée, estriadas

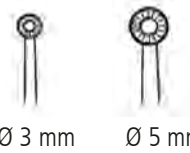

Ø 3 mm

Ø 5 mm

18626-3

18626-5



18608-15

15,0 cm/6"
 gerade, straight
 droite, rectas



18609-15

15,0 cm/6"
 gebogen, curved
 courbe, curvas



18608-18

18,0 cm/7"
 gerade, straight
 droite, rectas



18609-18

18,0 cm/7"
 gebogen, curved
 courbe, curvas





SCHWERT
SWORD · ESPADA
EPEE · SPADA

Cilienpinzetten Cilia Forceps Pincès à épiler les cils Pinzas depilatorias



Beer
glatt, smooth,
lisse, lisas

19742 8,0 cm/3¼"

19742-9 9,0 cm/3½"



Littauer
gerieft, serrated
striée, estriadas

19744 8,5 cm/3½"



Douglas
schmal, narrow
etroite, estrechas

19746-1 9,0 cm/3½"



Douglas
breit, broad
large, anchas

19746-2 9,0 cm/3½"



SCHWERT
SWORD · ESPADA
EPEE · SPADA

Scheren, Supercut-Scheren Scissors, Supercut Scissors Ciseaux, Ciseaux Supercut Tijeras, Tijeras Supercut





SCHWERT
SWORD · ESPADA
EPEE · SPADA

Chirurgische Scheren
Operating Scissors
Ciseaux à chirurgie
Tijeras para cirugía



Standard

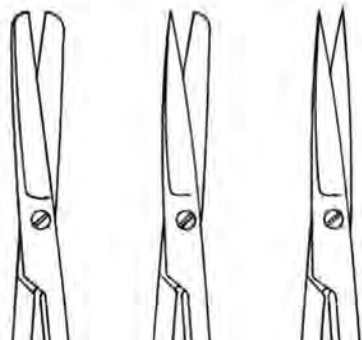

Standard

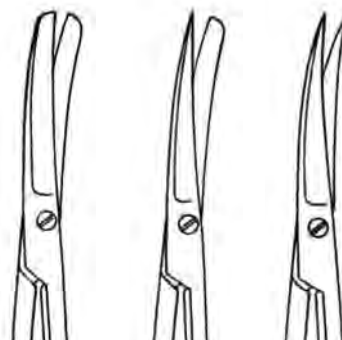
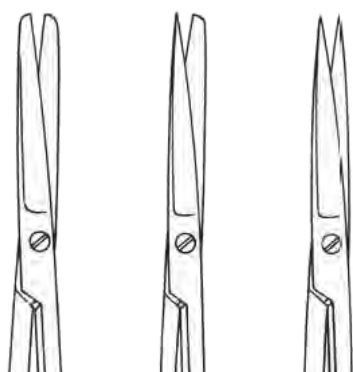

Fig. 1	Fig. 2	Fig. 3		Fig. 1	Fig. 2	Fig. 3
11550-A10	11550-B10	11550-C10	10,5 cm/4¼"	11551-A10	11551-B10	11551-C10
11550-A11	11550-B11	11550-C11	11,5 cm/4½"	11551-A11	11551-B11	11551-C11
11550-A13	11550-B13	11550-C13	13,0 cm/5"	11551-A13	11551-B13	11551-C13
11550-A14	11550-B14	11550-C14	14,5 cm/5½"	11551-A14	11551-B14	11551-C14
11550-A15	11550-B15	11550-C15	15,5 cm/6"	11551-A15	11551-B15	11551-C15
11550-A16	11550-B16	11550-C16	16,5 cm/6½"	11551-A16	11551-B16	11551-C16
11550-A18	11550-B18	11550-C18	18,5 cm/7¼"	11551-A18	11551-B18	11551-C18
11550-A20	11550-B20	11550-C20	20,0 cm/8"	11551-A20	11551-B20	11551-C20



Grazil



Grazil

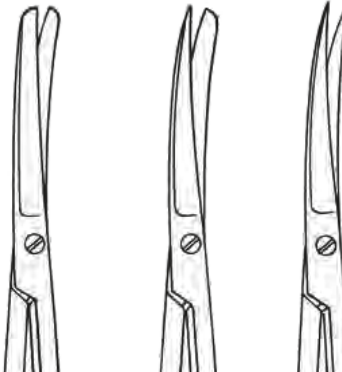

Fig. 1	Fig. 2	Fig. 3		Fig. 1	Fig. 2	Fig. 3
11554-A13	11554-13	11554-C13	13,0 cm/5"	11555-A13	11555-13	11555-C13
11554-A14	11554-14	11554-C14	14,5 cm/5½"	11555-A14	11555-14	11555-C14

Chirurgische Scheren
Operating Scissors
Ciseaux à chirurgie
Tijeras para cirugía



SCHWERT
 SWORD · ESPADA
 EPEE · SPADA



11576-114

gezahnt, saw edge
 denteles, dentadas

11576-14

Deaver
 14,5 cm/5½"



11577-114

gezahnt, saw edge
 denteles, dentadas

11577-14



11640-1

11640-5

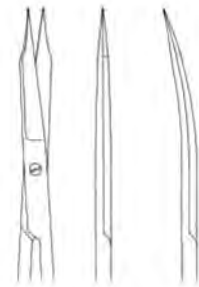

Goldmann-Fox
 13,0 cm/5"

Inzisionsschere
Incision Scissors
Ciseaux à incision
Tijeras para incisión



10156-13 13,0 cm/5"

10156-14 14,5 cm/5½"



Richter
 15,5 cm/6"

11597-2 14,5 cm/5½"



11590-115

gezahnt, saw edge
 dentelés, dentadas

11590-15

Mixer
 15,5 cm/6"



11591-115

gezahnt, saw edge
 dentelés, dentadas

11591-15



SCHWERT
SWORD · ESPADA
EPEE · SPADA

Präparierscheren
Dissecting Scissors
Ciseaux à dissection
Tijeras para preparaciones



Mayo

11558-14	14,5 cm/5½"	11559-14
11558-15	15,0 cm/6"	11559-15
11558-17	17,0 cm/6¾"	11559-17
11558-23	23,0 cm/9"	11559-23

Mayo-Stille

11560-15	15,0 cm/6"	11561-15
11560-17	17,0 cm/6¾"	11561-17
11560-21	21,0 cm/8¼"	11561-21



Mayo-Noble

11568-17	17,0 cm/6¾"	11569-17
-----------------	-------------	-----------------

Mayo-Harrington

11558-123	23,0 cm/9"	11559-123
------------------	------------	------------------

**Präparierscheren
Dissecting Scissors
Ciseaux à dissection
Tijeras para preparaciones**



SCHWERT
SWORD · ESPADA
EPEE · SPADA



Bauchdecken-Scheren
Abdominal Scissors
Ciseaux abdominaux
Tijeras abdominales

Doyen

26778-16	16,0 cm/6¼"	26779-16
26778	17,5 cm/7"	26779



Mayo-Lexer

11562-16 16,0 cm/6¼"



11563-16



Baby-Lexer

11562-10 10,0 cm/4"



11563-10



SCHWERT
SWORD · ESPADA
EPEE · SPADA

Präparierscheren
Dissecting Scissors
Ciseaux à dissection
Tijeras para preparaciones

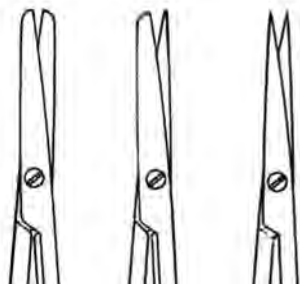

Fig. 1 **Fig. 2** **Fig. 3**
11580-14 **11580-B14** **11580-C14**

Metzenbaum
14,5 cm/5½"

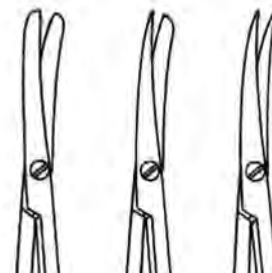
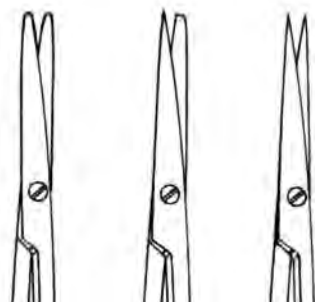
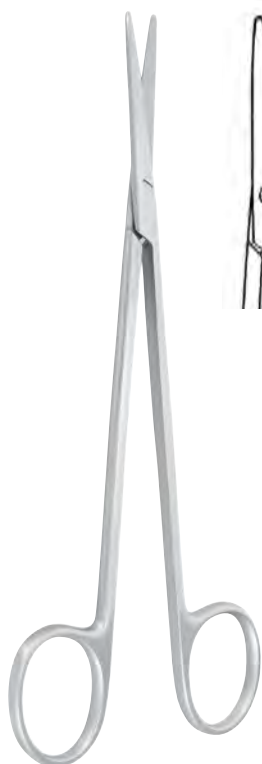

Fig. 1 **Fig. 2** **Fig. 3**
11581-14 **11581-B14** **11581-C14**

Metzenbaum
14,5 cm/5½"



Metzenbaum

Fig. 1	Fig. 2	Fig. 3	
11580-18	11580-B18	11580-C18	18,0 cm/7"
11580-20	11580-B20	11580-C20	20,0 cm/8"
11580-23	11580-B23	11580-C23	23,0 cm/9"
11580-25	11580-B25	11580-C25	25,0 cm/10"
11580-28	11580-B28	11580-C28	28,0 cm/11"
11580-30	11580-B30	11580-C30	30,0 cm/12"

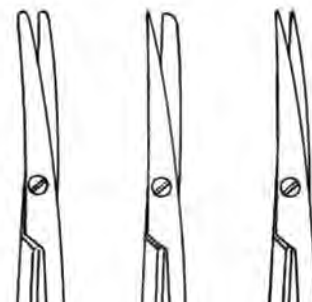
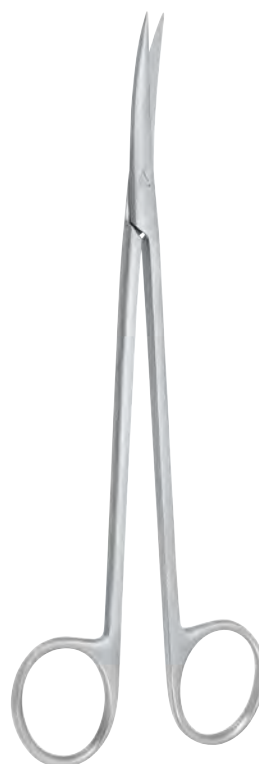

Metzenbaum

Fig. 1	Fig. 2	Fig. 3	
11581-18	11581-B18	11581-C18	18,0 cm/7"
11581-20	11581-B20	11581-C20	20,0 cm/8"
11581-23	11581-B23	11581-C23	23,0 cm/9"
11581-25	11581-B25	11581-C25	25,0 cm/10"
11581-28	11581-B28	11581-C28	28,0 cm/11"
11581-30	11581-B30	11581-C30	30,0 cm/12"

Präparierscheren
Dissecting Scissors
Ciseaux à dissection
Tijeras para preparaciones



SCHWERT
SWORD · ESPADA
EPEE · SPADA



Metzenbaum, Fino

11578-14	14,5 cm/5½"	11579-14
11578-15	15,0 cm/6"	11579-15
11578-18	18,0 cm/7"	11579-18
11578-20	20,0 cm/8"	11579-20
11578-23	23,0 cm/9"	11579-23

Metzenbaum, Lahey

11578-114	14,0 cm/4¾"	11579-114
------------------	-------------	------------------

Chirurgische und gynäkologische Schere
Operating and gynecological Scissors
Ciseaux à Chirurgie et à gynécologie
Tijeras para cirugía y ginecología

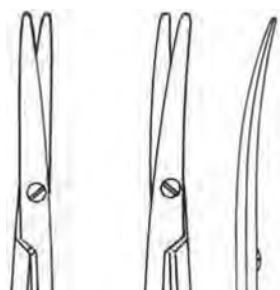

11580-11

11581-11



11593



Wertheim

11591-14	14,5 cm/5½"
11591-19	19,5 cm/7¾"
11591-22	22,5 cm/9"

**Metzenbaum
(Strabismus)**
11,5 cm/4½"

Strabismus
11592
11,5 cm/4½"



SCHWERT
SWORD · ESPADA
EPEE · SPADA

Irisscheren Iris Scissors Ciseaux pour l'iris Tijeras para iris



kantige Ausführung
square shanks
modèle anguleux
modelo anguloso

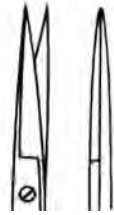

gerade
straight
droits
rectas

9,0 cm/3½"

11610-9



gebogen
curved
courbes
curvas

11611-9



seitwärts gebogen
curved sideways
courbe à la côté
curva lateral

11611-21



seitwärts abgewinkelt
angular on side
coude à la côté
acodada lateral

11611-31

10,5 cm/4¼"

11610-10

11611-10

11611-22

11611-32

11,5 cm/4¾"

11610-11

11611-11

11611-23

11611-33



runde Ausführung
round shanks
modèle rond
modelo redondo

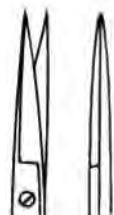

gerade
straight
droits
rectas

9,0 cm/3½"

11608-9



gebogen
curved
courbes
curvas

11609-9



seitwärts gebogen
curved sideways
courbe à la côté
curva lateral

11609-21



seitwärts abgewinkelt
angular on side
coude à la côté
acodada lateral

11609-31

10,5 cm/4¼"

11608-10

11609-10

11609-22

11609-32

11,5 cm/4¾"

11608-11

11609-11

11609-23

11609-33

Irisscheren
Iris Scissors
Ciseaux pour l'iris
Tijeras para iris

Irisschere · Iris Scissors · Ciseaux pour · l'iris · Tijeras para iris



11605-10
 10,5 cm/4¼"
 gebogen, curved
 courbes, curvas

11604-10
 10,5 cm/4¼"

Augenscheren
Eye Scissors
Ciseaux oculaires
Tijeras oculares



Graefe
19825
 10,5 cm/4¼"

Sehnenscheren
Tenotomy Scissors
Ciseaux à ténatomie
Tijeras para tenotomía

Augenschere
 Eye Scissors
 Ciseaux oculaires
 Tijeras oculares



Le Grange
19826
 10,5 cm/4¼"

Sehnenscheren, Tenotomy Scissors, Ciseaux à ténatomie, Tijeras para tenotomía



11599-2 10,0 cm/4"
11598-2 11,0 cm/4½"
 gerade
 straight
 droits
 rectas

Stevens
 spitz, pointed
 pointus, agudas



11599-22
11598-22
 gebogen
 curved
 courbes
 curvas

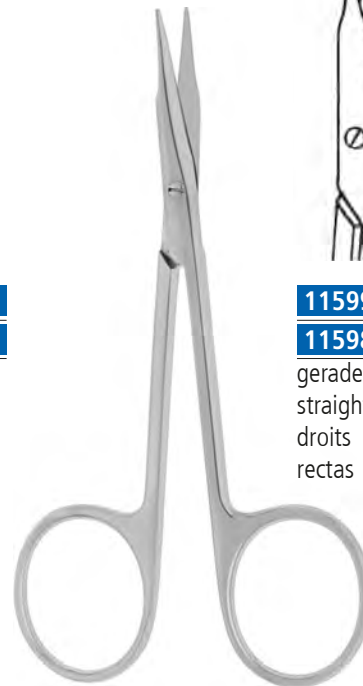

11599-1 10,0 cm/4"
11598-1 11,0 cm/4½"
 gerade
 straight
 droits
 rectas

Stevens
 stumpf, blunt
 mousses, romas



11599-21
11598-21
 gebogen
 curved
 courbes
 curvas



SCHWERT
 SWORD · ESPADA
 EPEE · SPADA





SCHWERT
SWORD · ESPADA
EPEE · SPADA

Chirurgische und gynäkologische Scheren
Operating and Gynecological Scissors
Ciseaux à chirurgie et à gynécologie
Tijeras para cirugía y ginecología



Fig. 1	Sims	Fig. 2
26720-A20	20,0 cm/8"	26720-B20
26720-A23	23,0 cm/9"	26720-B23



Fig. 1	Sims	Fig. 2
26725-A20	20,0 cm/8"	26725-B20
26725-A23	23,0 cm/9"	26725-B23



Feine Scheren
Delicate Scissors
Ciseaux fins
Tijeras finas

11624-1	16,0 cm/6¼"	11624-2
11624-5	18,0 cm/7"	11624-6



Uterusschere
Uterine Scissors
Ciseaux uterins
Tijeras para utero

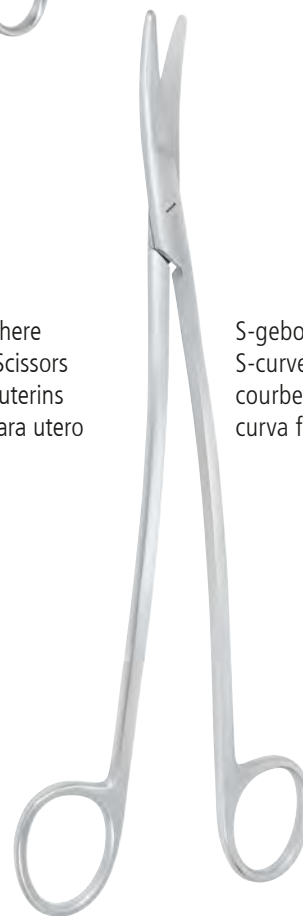

S-gebogen
S-curved
ciseaux courbes forme S
curva forma S

Siebold
26729 24,0 cm/9½"

Scheren für Geburtshilfe
Scissors for obstetrics
Ciseaux à obstétrique
Tijeras para obstetricia



SCHWERT
SWORD · ESPADA
EPEE · SPADA



26786

Kephalotomie-Scheren
Cephalotomy Scissors
Ciseaux à céphalotomie
Tijeras para cefalotomia

Dubois
27 cm/10½"



26787



26791-14
14,5 cm/5½"

Dammschere
Perineum Scissors
Ciseaux à périnée
Tijeras para perineo

Braun-Stadler



26791-22
22,0 cm/8¼"



Dammschere
Perineum Scissors
Ciseaux à périnée
Tijeras para perineo

Waldmann
26793 18,0 cm/7¼"



SCHWERT
SWORD · ESPADA
EPEE · SPADA

Scheren für Geburtshilfe
Scissors for obstetrics
Ciseaux à obstétrique
Tijeras para obstetricia

Nabelschnurscheren, Umbilical Scissors, Ciseaux pour le cordon ombilical, Tijeras umbilicales



Schumacher

27758 15,5 cm/6¼"



Busch

27761-13 15,5 cm/6¼"
27761-16 16,0 cm/6¼"



Mod.USA

27756 10,5 cm/4¼"

Feine Chirurgische Scheren
Delicate Operating Scissors
Ciseaux chirurgicaux fins
Tijeras finas para cirugía



11623-1

Joseph

14,5 cm/5½"



11623-2

Präparierscheren
Dissecting Scissors
Ciseaux à dissection
Tijeras para preparaciones



Kilner

11595-12 12,0 cm/4¾"
11595-13 13,0 cm/5"
11595-15 15,0 cm/6"



Littler

11596-12 12,0 cm/4¾"

Gefäßscheren
 Vascular Scissors
 Ciseaux vasculaires
 Tijeras vasculares



SCHWERT
 SWORD · ESPADA
 EPEE · SPADA



Lungenlappenscheren
 Lobectomy Scissors
 Ciseaux à lobectomie
 Tijeras para lobectomia

Crafoord

11641-30 30,0 cm/12"



17277

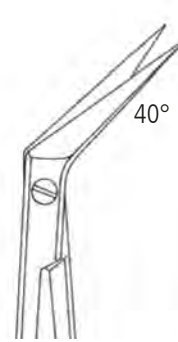

17278

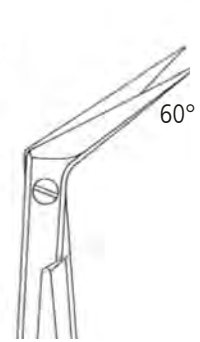

17279

60°

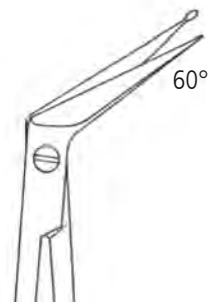

17279-1

60°



Potts-Smith

19,0 cm/7½"



SCHWERT
SWORD · ESPADA
EPEE · SPADA

Gefäßscheren
Vascular Scissors
Ciseaux vasculaires
Tijeras vasculares

Präparierscheren
Dissecting Scissors
Ciseaux à dissection
Tijeras para preparaciones



Gefäßschere
Vascular Scissors
Ciseaux vasculaires
Tijeras vasculares

Potts-Smith

11642-19 19,0 cm/7½"



Präparierschere
Dissecting Scissors
Ciseaux à dissection
Tijeras para preparaciones

Reynolds

11596-16 16,0 cm/6¼"



Gefäßschere
Vascular Scissors
Ciseaux vasculaires
Tijeras vasculares

Satinsky

17283-24 24,5 cm/10"



Knorpelschere
Cartilage Scissors
Ciseaux pour le cartilage
Tijeras para cartílago

Mc Indoe

11644-19 19,0 cm/7½"

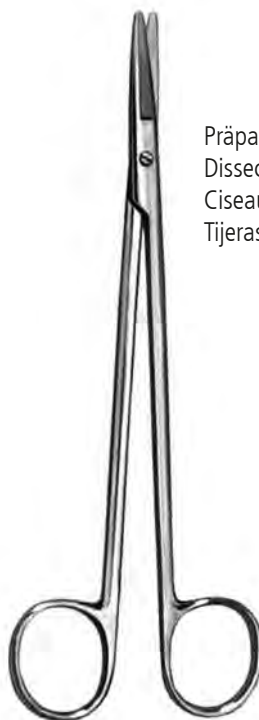

Präparierschere
Dissecting Scissors
Ciseaux à dissection
Tijeras para preparaciones

11646-18



Tönnis

18,0 cm/7"

11647-18

Scheren für Gewebe- und Gefäßchirurgie
 Tissue Scissors, Vascular Scissors
 Ciseaux pour la chirurgie tissulaire et vasculaire
 Tijeras para cirugía tisular y vascular



SCHWERT
 SWORD · ESPADA
 EPEE · SPADA



Präparierscheren
 Dissecting Scissors
 Ciseaux à dissection
 Tijeras para preparaciones

Adson-Tönnis

11648-17 17,5 cm/7"



Dandy

11649-17 17,0 cm/6¾"



Gefäßschere
 Vascular Scissors
 Ciseaux vasculaires
 Tijeras vasculares

Strully

11651-20 20,0 cm/8"

Gefäßschere
 Vascular scissors
 Ciseaux vasculaires
 Tijeras vasculares



11652-11 11,5 cm/4½"



Gefäßschere
 Vascular scissors
 Ciseaux vasculaires
 Tijeras vasculares

Schmieden

11653-17 17,0 cm/6¾"



Bronchialschere
 Bronchial Scissors
 Ciseaux pour les bronches
 Tijeras para bronquios

11654-14 14,5 cm/6"



SCHWERT
SWORD · ESPADA
EPEE · SPADA

Nasenscheren
Nasal Scissors
Ciseaux nasaux
Tijeras nasales

Tonsillenscheren
Tonsil Scissors
Ciseaux pour les amygdales
Tijeras para amígdalas

Nasenscheren, Nasal Scissors, Ciseaux nasaux, Tijeras nasales



Heymann

21236-18 18,0 cm/7"



Seiler

21238-17 17,0 cm/6¾"



Fomon

21244 14,0 cm/5½"

Tonsillenscheren, Tonsil Scissors, Ciseaux pour les amygdales, Tijeras para amígdalas



Böttcher

22203 18,0 cm/7"



Prince

22204 17,5 cm/7"



Good

22218 19,0 cm/7½"



Dean

22213 17,0 cm/6¾"

Ligatur- und Drahtscheren
Ligature Scissors and Wire Cutting Scissors
Ciseaux à ligatures, Coupe-fils alambre
Tijeras para ligaduras, Cizallas para cortar alambre



SCHWERT
 SWORD · ESPADA
 EPEE · SPADA



Ligatureschere
 11,5 cm/4½"

11602



11603



Littauer
11616 14,0 cm/5½"



Spencer
11615 9,0 cm/3½"
11616-11 10,5 cm/4"
11616-12 12,0 cm/4¾"

Drahtschere
Wire Cutting Scissors
Coupe-fils alambre
Cizallas para cortar alambre

Nagelspalt-Scheren, Nail Splitting Scissors,
Ciseaux à fendre les ongles, Tijeras para hender las uñas



Heath
11658-17 17,0 cm/6¾"



Universal
14145 12,0 cm/4¾"



Sistrunk
11660-13 13,0 cm/5"



11661-13



11662-15 17,0 cm/6¾"



SCHWERT
SWORD · ESPADA
EPEE · SPADA

Darmscheren
Enterotomy Scissors
Ciseaux entérotomes
Tijeras enterótomos

Anatomie-Scheren
Dissecting Scissors
Ciseaux à dissection
Tijeras para disección



Darmschere

10160 21,0 cm/8¼"

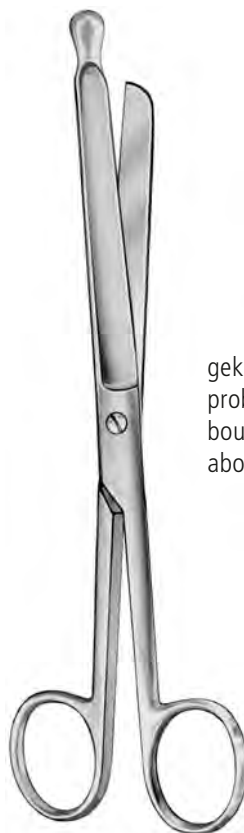

geknöpft
probe-pointed
boutonnés
abotonadas

Darmschere

10161 21,0 cm/8¼"



Anatomie-Scheren
Dissecting Scissors
Ciseaux à dissection
Tijeras para disección

10150-11 11,5 cm/4½"

10150-13 13,0 cm/5"

10150-14 14,5 cm/5½"



10151-11

10151-13

10151-14

Supercut Scheren
 Supercut Scissors
 Ciseaux Supercut
 Tijeras Supercut



SCHWERT
 SWORD · ESPADA
 EPEE · SPADA



Mayo

11558-414

14,5 cm/5½"

11558-415

15,5 cm/6¼"

11558-417

17,0 cm/6¾"



11559-414

11559-415

11559-417



Mayo-Style

11560-415

15,5 cm/6"

11560-417

17,0 cm/6¾"



11561-415

11561-417



11562-416

Mayo-Lexer

16,0 cm/6¼"



11563-416



Supercut Scheren
Supercut Scissors
Ciseaux Supercut
Tijeras Supercut

SCHWERT
SWORD - ESPADA
EPEE - SPADA



11580-414

Metzenbaum

14,5 cm/5½"



11581-414

Metzenbaum

14,5 cm/5½"



11580-418

Metzenbaum

18,0 cm/7"

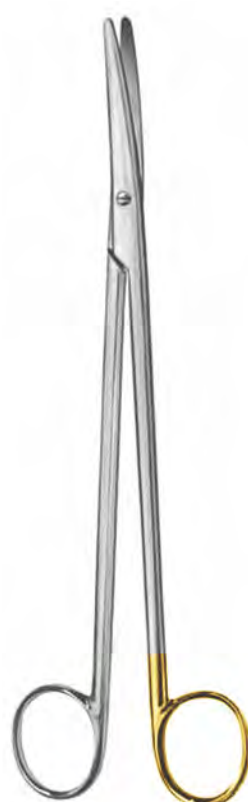

11581-418

Metzenbaum

18,0 cm/7"

Supercut Scheren
 Supercut Scissors
 Ciseaux Supercut
 Tijeras Supercut



SCHWERT
 SWORD · ESPADA
 EPEE · SPADA



11578-414

Metzenbaum, Fino

14,5 cm/5½"

11578-415

15,5 cm/6¼"



11579-414

11579-415



11580-411

**Metzenbaum
 (Strabismus)**

11,5 cm/4½"

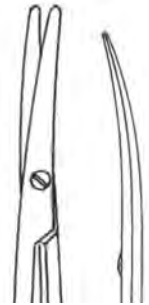

11581-411



Lister

11675-414

14,0 cm/5½"

11675-418

18,0 cm/7"

11675-420

20,0 cm/8"



Irischere

11,5 cm/4¾"

11610-411

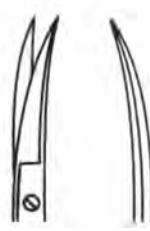

11611-411



Stevens

11,0 cm/4½"

stumpf, blunt
 mousses, romas

11598-401

11598-421





SCHWERT
SWORD · ESPADA
EPEE · SPADA

Instrumente für Verband und Gips Bandage and Plaster Instruments Instruments pour pansements et plâtre Instrumentos para vendajes y yeso



Verbandscheren
 Bandage Scissors
 Ciseaux pour pansements
 Tijeras para vendajes



SCHWERT
 SWORD · ESPADA
 EPEE · SPADA



Smith

11656-18 20,0 cm/8"
11656-20 23,0 cm/9"



Lorenz

11658-23 23,0 cm/9"



Knowles

14,5 cm/5½"
11660-14



Lister

11675-9 9,0 cm/3½"
11675-11 11,0 cm/4½"
11675-14 14,0 cm/5½"
11675-18 18,0 cm/7"
11675-20 20,0 cm/8"



Esmarch

11691-20 20,0 cm/8"
11691-22 23,0 cm/9"



SCHWERT
SWORD · ESPADA
EPEE · SPADA

Verbandscheren
Bandage Scissors
Ciseaux pour pansements
Tijeras para vendajes



Bruns
24,0 cm/9½"

11694

glatt, smooth
lisses, lisas

11695

gezahnt, saw edge
denteles, dentadas



Lister
18,0 cm/7"

11720

schwarz, black
noir, negro

15,0 cm/6"

11720-15

schwarz, black
noir, negro



Bergmann
23,0 cm/9"

11722-23

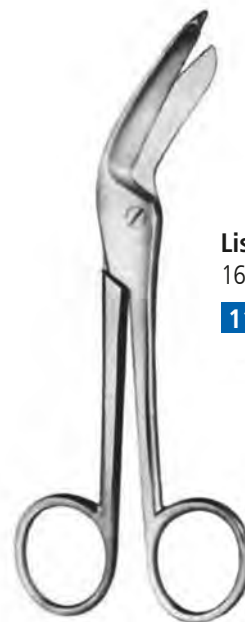

Lister-Excentric
16,0 cm/6¼"

11676-16

Gipsmesser
Plaster-of-Paris knives
Couteaux a plâtre
Cuchillos para yeso

Gipsscheren
Plaster-of-Paris Shears
Ciseaux pour pansements et plâtre
Tijeras para vendajes



SCHWERT
 SWORD · ESPADA
 EPEE · SPADA



Seutin
 23,0 cm/9"
11699-23



Stille
 24,0 cm/9½"
11865-24

verstärkter Rücken
 reinforced back
 à dos renforce
 lomo reforzado



11867-26
 26,0 cm/10½"

11867-37
 37,0 cm/14½"



Esmarch
 18,0 cm/7"
11808



Reiner
 18,0 cm/7"
11809



Hopkins
 20,0 cm/8"
11812



Stille
11866-23 23,0 cm/9"
11866-26 26,0 cm/10½"
11866-37 37,0 cm/14½"



SCHWERT
SWORD · ESPADA
EPEE · SPADA

Gipsabreißzange, Gipsspreizer, Gipssägen
Plaster Cast Instruments
Pincés et cisailles pour les plâtres
Instrumental para vendajes enyesados



USA-Modell

11885 23,0 cm/9"



Engel

11837



Wolf

11895-18 18,0 cm/7"

11895 24,0 cm/9½"



Henning

11882 28,0 cm/11"



Haglund-Stille

11884 28,0 cm/11"

Oszillierende Gipssägen
Oscillating Plaster Saws
Scie oscillante a plâtre
Sierra oscilante para yeso



SCHWERT
SWORD · ESPADA
EPEE · SPADA



29831 230 V

Oszillosäge

komplett mit
1 Sägeblatt 50 mm(29821-50)
1 Sägeblatt 65 mm(29821-65)
2 Gabelschlüssel

Oscillating saw

complete with
1 saw blade 50 mm(29821-50)
1 saw blade 65 mm(29821-65)
2 open-end wrenches

Scie oscillante à plâtre

complet avec
1 lame de scie 50 mm(29821-50)
1 lame de scie 65 mm(29821-65)
2 clés

Sierra oscilante para vendajes enyesados

completa con
1 hoja de sierra 50 mm(29821-50)
1 hoja de sierra 65 mm(29821-65)
2 flaves



Motorkühlung nach dem Umwälzprinzip

Motor cooling due to a circulation principle



Drehzahlregelung für optimale Sägeblattschwingung

Speed controller for precise adjustment of the rotation of the sawblades



Ergonomischer Schalter
Ergonomical Switch



Einfacher Wechsel des Sägeblattes

Saw blades can be easily changed



SCHWERT
SWORD · ESPADA
EPEE · SPADA

Oszillierende Gipssägen Oscillating Plaster Saws Scie oscillante a plâtre Sierra oscilante para yeso

29850 230 V

Oszillosäge

komplett mit

- 1 Sägeblatt 65 mm(29820-65)
- 1 Sägeblatt 65 mm(29821-65)
- 1 Innensechskantschlüssel

Oscillating saw

complete with

- 1 saw blade 65 mm(29820-65)
- 1 saw blade 65 mm(29821-65)
- 1 hexagonal key

Scie oscillante à plâtre

complet avec

- 1 lame de scie 65 mm(29820-65)
- 1 lame de scie 65 mm(29821-65)
- 1 clés

Sierra oscilante para vendajes enyesados

completa con

- 1 hoja de sierra 65 mm(29820-65)
- 1 hoja de sierra 65 mm(29821-65)
- 1 flaves



29855 230 V

Oszillosäge Accu

komplett mit

- 1 Sägeblatt 65 mm(29820-65)
- 1 Sägeblatt 65 mm(29821-65)
- 1 Ladegerät
- 1 Innensechskantschlüssel

Oscillating saw Accu

complete with

- 1 saw blade 65 mm(29820-65)
- 1 saw blade 65 mm(29821-65)
- 1 loading unit
- 1 hexagonal key

Scie oscillante à plâtre Accu

complet avec

- 1 lame de scie 65 mm(29820-65)
- 1 lame de scie 65 mm(29821-65)
- 1 Appareil de rechargement
- 1 clés

Sierra oscilante para vendajes enyesados Accu

completa con

- 1 hoja de sierra 65 mm(29820-65)
- 1 hoja de sierra 65 mm(29821-65)
- 1 Aparato para recargar
- 1 flaves



Motorkühlung nach dem
Umwälzprinzip

Motor cooling due to a
circulation principle



Drehzahlregelung für opti-
male Sägeblattschwingung

Speed controller for precise
adjustment of the rotation
of the sawblades



Ergonomischer Schalter
Ergonomical Switch



Einfaches Wechseln des
Akkus

Accu can be easily
changed

Oszillierende Gipssägen
Oscillating Plaster Saws
Scie oscillante a plâtre
Sierra oscilante para yeso



SCHWERT
SWORD · ESPADA
EPEE · SPADA



29860 230 V

Oszillosäge Accu

komplett mit
1 Sägeblatt 50 mm(29821-50)
1 Sägeblatt 65 mm(29821-65)
1 Ladegerät
2 Gabelschlüssel

Oscillating saw Accu

complete with
1 saw blade 50 mm(29821-50)
1 saw blade 65 mm(29821-65)
1 loading unit
2 open-end wrenches

Scie oscillante à plâtre Accu

complet avec
1 lame de scie 50 mm(29821-50)
1 lame de scie 65 mm(29821-65)
1 Appareil de rechargement
2 clés

Sierra oscilante para vendajes enyesados Accu

completa con
1 hoja de sierra 50 mm(29821-50)
1 hoja de sierra 65 mm(29821-65)
1 Aparato para recargar
2 flaves



Einfaches Wechseln des Akkus

Accu can be easily changed

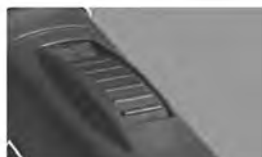

Ergonomischer Schalter
Ergonomical Switch



Einfacher Wechsel des Sägeblattes
Saw blades can be easily changed



SCHWERT
SWORD · ESPADA
EPEE · SPADA

Oszillierende Gipssägen Oscillating Plaster Saws Scie oscillante à plâtre Sierra oscilante para yeso



Rundsägeblatt Ø 44 mm
Round Saw Blades Ø 44 mm

29820-44

für Gips
for Plaster Casts

29821-44

für Synthetik-Verbände,
oberflächenbeschichtet
for Synthetic-Dressings,
surface coated



Segment-Sägeblatt Ø 65 mm
Segment Saw Blades Ø 65 mm

29820-165

für Gips
for Plaster Casts

29821-165

oberflächenbeschichtet
surface coated



Rundsägeblatt Ø 50 mm
Round Saw Blades Ø 50 mm

29820-50

für Gips
for Plaster Casts

29821-50

für Synthetik-Verbände,
oberflächenbeschichtet
for Synthetic-Dressings,
surface coated

29822-50

TiN-beschichtet, extra hart
TiN coated, extra hard



Tailen-Sägeblatt Ø 65 mm
Waisted Saw Blades Ø 65 mm

29820-265

für Gips
for Plaster Casts

29821-265

oberflächenbeschichtet
surface coated



Rundsägeblatt Ø 65 mm
Round Saw Blades Ø 65 mm

29820-65

für Gips
for Plaster Casts

29821-65

für Synthetik-Verbände,
oberflächenbeschichtet
for Synthetic-Dressings,
surface coated

29822-65

TiN-beschichtet, extra hart
TiN coated, extra hard



Tiefensägeblatt Ø 70 mm
Deep Saw Blades Ø 70 mm

29820-170

für Gips
for Plaster Casts

29821-170

oberflächenbeschichtet
surface coated

Oszillierende Gipssägen
Oscillating Plaster Saws
Scie oscillante à plâtre
Sierra oscilante para yeso



SCHWERT
 SWORD · ESPADA
 EPEE · SPADA

Spezielle Anschlussstecker für einige Länder:
Special plugs for some countries:

3-polig „Australien“, 240 V, 50 Hz
 3-poles „Australia“, 240 V, 50 Hz
 please use **Code A**



3-polig „UK“, 110 V, 50 Hz
 3-poles „UK“, 110 V, 50 Hz
 please use **Code B**



3-polig „UK“, 240 V, 50 Hz
 3-poles „UK“, 240 V, 50 Hz
 please use **Code G**



2-polig „Schweiz“, 240 V, 50 Hz
 2-poles „Suisse“, 240 V, 50 Hz
 please use **Code S**



2-polig „USA“, 120 V, 50 Hz
 2-poles „USA“, 120 V, 50 Hz
 please use **Code V**



Koffer passend für Sägen
Cases suitable for saws

- 29825-1** 29831, 29840
- 29825-2** 29860, 29865
- 29825-3** 29850
- 29825-4** 29855



Accu

- 29826-17**
- 1700 mAh (Funktion: ca. 30 min)
- 1700 mAh (Function: approx. 30 min)



Schnell-Ladegerät
Quick Recharger

- 29827-230** 230V / 110W



Tube mit Spezialfett
Tube with Special Lubrication
Grease

- 29828** 230V / 110W



SCHWERT
SWORD - ESPADA
EPEE - SPADA

Naht

Suture

Suture

Sutura



**Nadelhalter
Needle Holders
Porte-aiguilles
Porta-agujas**



SCHWERT
SWORD · ESPADA
EPEE · SPADA



Collier

12427 12,5 cm/5"

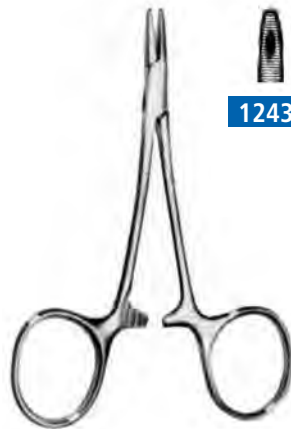

Derf

12,5 cm/5"

12430

12432



Halsey

12437-2 13,0 cm/5" **12437-1**

gerieft
serrated
striée
estriada

glatt
smooth
lisse
lisa



Webster

12428 13,0 cm/5"

glatt
smooth
lisse
lisa



Crile-Wood

12434 15,0 cm/6"

mit Rille
with groove
avec cannelure
con ranura



Brown

12424-13 13,0 cm/5"

12424-18 18,0 cm/7"



SCHWERT
SWORD · ESPADA
EPEE · SPADA

Nadelhalter
Needle Holders
Porte-aiguilles
Porta-agujas



Sarat

12446-18 18,0 cm/7¼"
12446-26 26,0 cm/10¼"



M.G.H.

12447-17 17,0 cm/6¾"

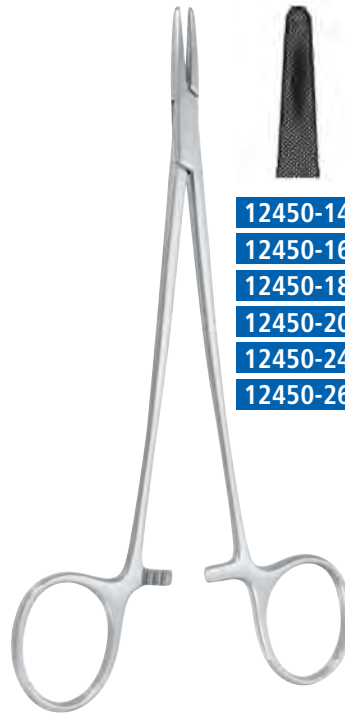

Mayo-Hegar

12450-14 14,0 cm/5½"
12450-16 16,0 cm/6¼"
12450-18 18,0 cm/7¼"
12450-20 20,0 cm/8"
12450-24 24,0 cm/9½"
12450-26 26,0 cm/10¼"

12451-16
12451-18
12451-20
12451-24
12451-26



schlankes Modell
slender pattern
modele gracile
modelo delgado

Mayo-Hegar

12450-116 16,0 cm/6¼"
12450-118 18,0 cm/7"
12450-120 20,0 cm/8"



Gillies

11625 16,0 cm/6¼"



Hegar-Baumgartner

12448-14 14,0 cm/5½"

**Nadelhalter
Needle Holders
Porte-aiguilles
Porta-agujas**



SCHWERT
SWORD · ESPADA
EPEE · SPADA



für sehr feine Nadeln
for fine needles
pour des aiguilles tres fines
para agujas finas

Baby-Olsen-Hegar
11,5 cm/4½"

11628-11

gerieft
serrated
striée
estriada

11628-111

glatt
smooth
lisse
lisa



Olsen-Hegar

11628-14 14,0 cm/5½"



Olsen-Hegar

11628-16 16,0 cm/6¼"

kräftige Ausführung
heavy pattern
modele robuste
de fuerte construcción



Olsen-Hegar

11628-114 14,0 cm/5½"



Olsen-Hegar

11628-116 17,0 cm/6¼"



Olsen-Hegar

11628-18 18,0 cm/7"



Crile-Wood

12435-15 15,0 cm/6"

12435-18 18,0 cm/7"

12435-20 20,0 cm/8"

12435-23 23,0 cm/9"



SCHWERT
SWORD · ESPADA
EPEE · SPADA

**Nadelhalter
Needle Holders
Porte-aiguilles
Porta-agujas**



Heaney

12461-21 21,0 cm/8¼"
12461-26 26,0 cm/10¼"

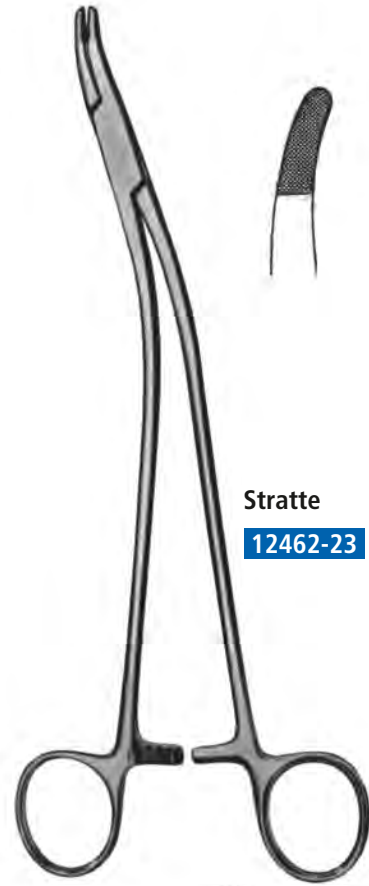

Stratte

12462-23 23,0 cm/9"

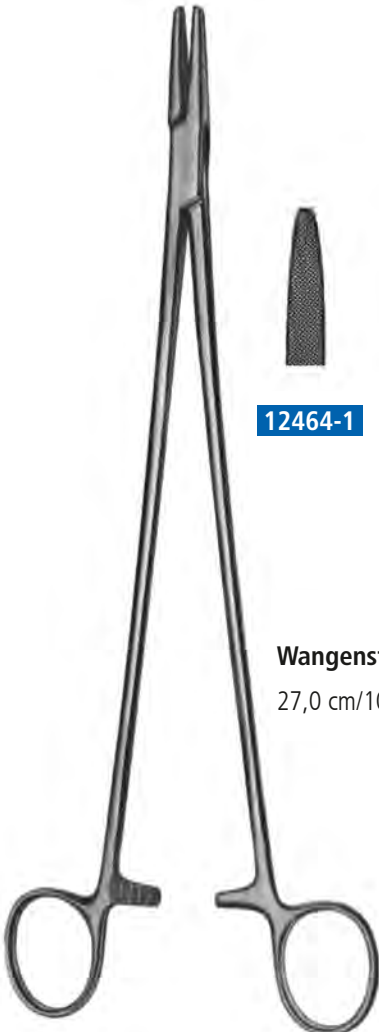

12464-1

12464

Wangenstein

27,0 cm/10½"



Masson

12460
27,0 cm/10½"



Finochietto

12471-27
27,0 cm/10½"

**Nadelhalter
Needle Holders
Porte-aiguilles
Porta-agujas**



SCHWERT
SWORD · ESPADA
EPEE · SPADA



Crile

12400-15 15,0 cm/6"



Adson

12440 18,0 cm/7"



12507-17 17,0 cm/6½"
12507-20 20,0 cm/8"



12507-117
12507-120

Mathieu



12506-14 14,5 cm/5½"
12506-17 17,0 cm/6½"
12506-20 20,0 cm/8"



12506-114
12506-117
12506-120

Mathieu



12506-A14 14,0 cm/5½"
12506-A17 17,0 cm/6¾"

schlankes Maul
slender jaw
mors étroit
boca fina

12506-217 17,0 cm/6½"
12506-220 20,0 cm/8"

kräftige Ausführung
heavy pattern
modele robuste
de fuerte construcción



Augennadelhalter
Eye Needle Holders
Porte-aiguilles pour les yeux
Porta-agujas para ojos

SCHWERT
 SWORD · ESPADA
 EPEE · SPADA

mit Sperre, with ratchet
avec crémaillère, con cremallera

1:1

ohne Sperre, without ratchet
sans crémaillère, sin cremallera



19950-14

14,0 cm/5½"

19950-18

18,0 cm/7"

19950-21

21,0 cm/8¼"

gerade
 straight
 droite
 recta



19951-14

19951-18

19951-21

gebogen
 curved
 courbe
 curva



19950-114

14,0 cm/5½"

gerade
 straight
 droite
 recta



19951-114

gebogen
 curved
 courbe
 curva



19952-14

14,0 cm/5½"

gerade
 straight
 droite
 recta



19953-14

gebogen
 curved
 courbe
 curva



Castroviejo

Augennadelhalter
Eye Needle Holders
Porte-aiguilles pour les yeux
Porta-agujas para ojos



SCHWERT
 SWORD · ESPADA
 EPEE · SPADA



19920-1

gerade
 straight
 droite
 recta



19920-2

gebogen
 curved
 courbe
 curva



Arruga
 16,0 cm/6¼"



Kalt

19914 14,0 cm/5½"



Barraquer

19960-13 13,5 cm/5"

19960-18 18,0 cm/7"

gerade
 straight
 droite
 recta



19961-13

19961-18

gebogen
 curved
 courbe
 curva









Mikro-Nadelhalter
Micro Needle Holders
Porte-aiguilles pour micro-chirurgie
Porta-agujas para micro-cirugía

1:1

SCHWERT
 SWORD · ESPADA
 EPEE · SPADA

ohne Sperre, without ratchet
 sans crémaillère, sin cremallera



- | | | | | | | | | |
|---|--|---|--|---|--|---|------------|--------------------------------------|
|  |  |  |  |  |  |  | | |
| 18712-13 | 13,5 cm/5½" | 18713-13 | 18712-14 | 14,5 cm/6" | 18713-14 | 18712-18 | 18,0 cm/7" | 18713-18 |
| gerade
straight
droite
recta | | gebogen
curved
courbe
curva | gerade
straight
droite
recta | | gebogen
curved
courbe
curva | gerade
straight
droite
recta | | gebogen
curved
courbe
curva |

Mikro-Nadelhalter
Micro Needle Holders
Porte-aiguilles pour micro-chirurgie
Porta-agujas para micro-cirugía

1:1



SCHWERT
 SWORD · ESPADA
 EPEE · SPADA

mit Sperre, with ratchet
 avec crémaillère, con cremallera



- | | | | | | | | | |
|-----------------|-------------|-----------------|-----------------|------------|-----------------|-----------------|------------|-----------------|
| 18714-13 | 13,5 cm/5½" | 18715-13 | 18714-14 | 14,5 cm/6" | 18715-14 | 18714-18 | 18,0 cm/7" | 18715-18 |
| gerade | | gebogen | gerade | | gebogen | gerade | | gebogen |
| straight | | curved | straight | | curved | straight | | curved |
| droite | | courbe | droite | | courbe | droite | | courbe |
| recta | | curva | recta | | curva | recta | | curva |



SCHWERT
SWORD - ESPADA
EPEE - SPADA

Wundklammer-Pinzetten / -Zangen
Clip Applying Forceps
Pinces pour agrafes
Pinzas para agrafes



Michel (1x2)

12047 12,0 cm/4¾"



Michel

12048 12,0 cm/4¾"



Hegenbarth

12050 12,5 cm/5"



Wachenfeldt

12059 12,5 cm/5"



Wundklammer-Zangen
Clip Applying Forceps
Pinces pour agrafes
Pinzas para agrafes

Michel (1x2)

12044 12,0 cm/4¾"



Collin

12041 13,0 cm/5¼"

**Unterbindungsnadeln
Ligature Needles
Aiguilles à ligatures
Agujas para ligaduras**



SCHWERT
SWORD · ESPADA
EPEE · SPADA

gebogen für
die rechte Hand
curved to the left,
for the right hand
courbe à gauche
pour la main droite
curva a la izquierda
para la mano derecha

rechts gebogen für
die linke Hand
curved to the right,
for the left hand
courbe à droite
pour la main gauche
curva a la derecha
para la mano izquierda

links gebogen für
die rechte Hand
curved to the left,
for the right hand
courbe à gauche
pour la main droite
curva a la izquierda
para la mano derecha

rechts gebogen für
die linke Hand
curved to the right,
for the left hand
courbe à droite
pour la main gauche
curva a la derecha
para la mano izquierda



Deschamps
20,0 cm/8"

12152-1

stumpf
blunt
mousse
roma

Deschamps
20,0 cm/8"

12152-2

stumpf
blunt
mousse
roma

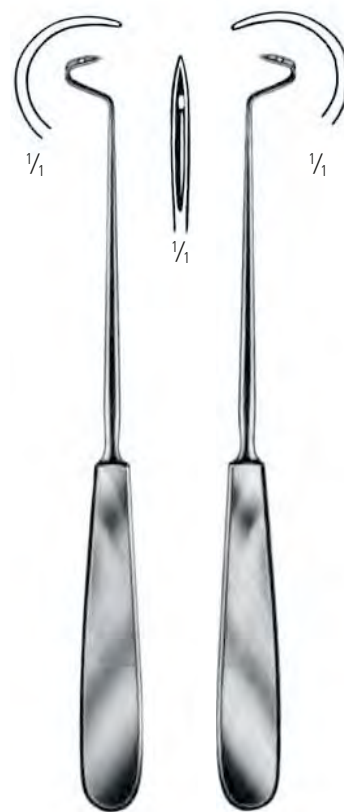

Deschamps
20,0 cm/8"

12150-1

scharf
sharp
pointue
aguda

Deschamps
20,0 cm/8"

12150-2

scharf
sharp
pointue
aguda



SCHWERT
SWORD · ESPADA
EPEE · SPADA

Unterbindungsnadeln Ligature Needles Aiguilles à ligatures Agujas para ligaduras

links gebogen für
die rechte Hand
curved to the left,
for the right hand
courbe à gauche
pour la main droite
curva a la izquierda
para la mano derecha

rechts gebogen für
die linke Hand
curved to the right,
for the left hand
courbe à droite
pour la main gauche
curva a la derecha
para la mano izquierda

links gebogen für
die rechte Hand
curved to the left,
for the right hand
courbe à gauche
pour la main droite
curva a la izquierda
para la mano derecha

rechts gebogen für
die linke Hand
curved to the right,
for the left hand
courbe à droite
pour la main gauche
curva a la derecha
para la mano izquierda

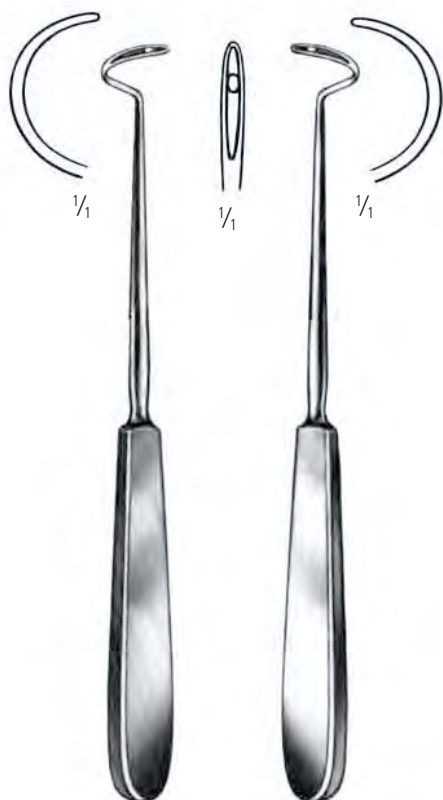

Deschamps
20,0 cm/8"

12157-1

stumpf
blunt
mousse
roma

Deschamps
20,0 cm/8"

12157-2

stumpf
blunt
mousse
roma

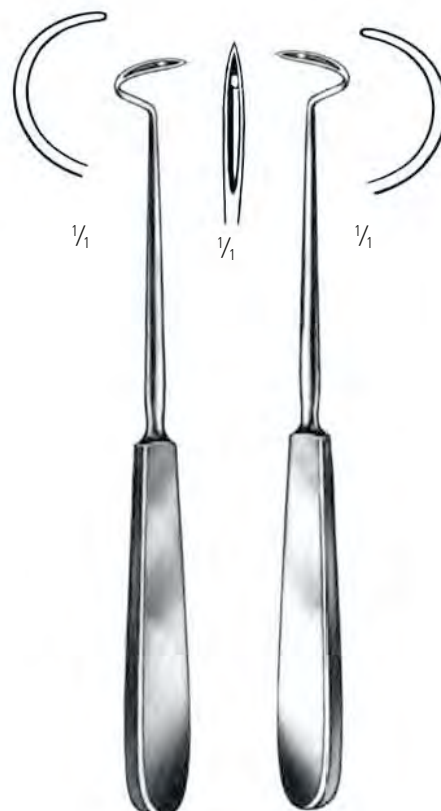

Deschamps
20,0 cm/8"

12155-1

scharf
sharp
pointue
aguda

Deschamps
20,0 cm/8"

12155-2

scharf
sharp
pointue
aguda

**Unterbindungsnadeln
Ligature Needles
Aiguilles à ligatures
Agujas para ligaduras**



SCHWERT
SWORD · ESPADA
EPEE · SPADA

links gebogen für
die rechte Hand

curved to the left,
for the right hand

courbe à gauche
pour la main droite

curva a la izquierda
para la mano derecha

rechts gebogen für
die linke Hand

curved to the right,
for the left hand

courbe à droite
pour la main gauche

curva a la derecha
para la mano izquierda

links gebogen für
die rechte Hand

curved to the left,
for the right hand

courbe à gauche
pour la main droite

curva a la izquierda
para la mano derecha

rechts gebogen für
die linke Hand

curved to the right,
for the left hand

courbe à droite
pour la main gauche

curva a la derecha
para la mano izquierda

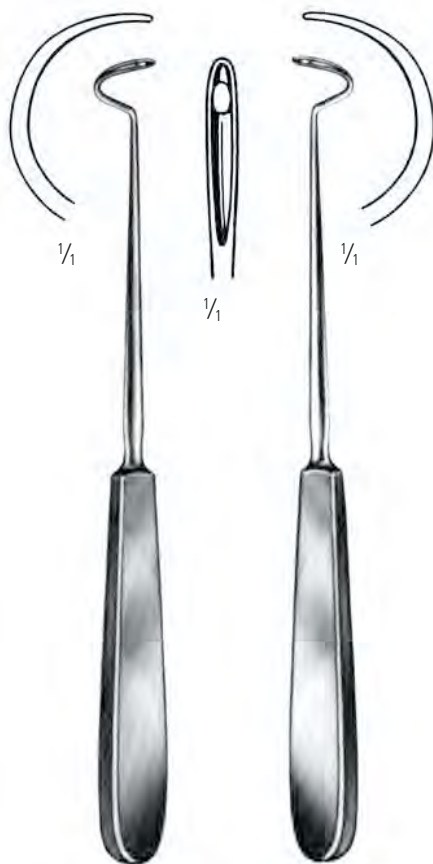

Deschamps
21,0 cm/8¼"

12162-1

stumpf
blunt
mousse
roma

Deschamps
21,0 cm/8¼"

12162-2

stumpf
blunt
mousse
roma

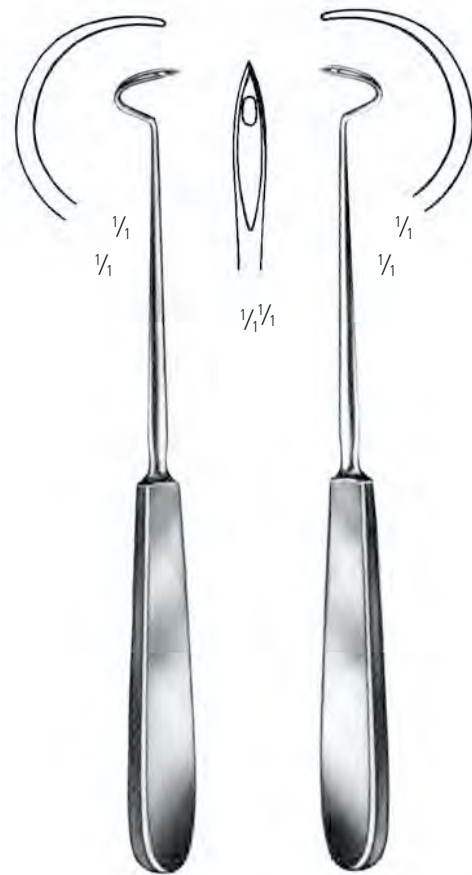

Deschamps
21,0 cm/8¼"

12160-1

scharf
sharp
pointue
aguda

Deschamps
21,0 cm/8¼"

12160-2

scharf
sharp
pointue
aguda



SCHWERT
SWORD · ESPADA
EPEE · SPADA

Unterbindungsnadeln Ligature Needles Aiguilles à ligatures Agujas para ligaduras

links gebogen für
die rechte Hand

curved to the left,
for the right hand

courbe à gauche
pour la main droite

curva a la izquierda
para la mano derecha

rechts gebogen für
die linke Hand

curved to the right,
for the left hand

courbe à droite
pour la main gauche

curva a la derecha
para la mano izquierda

links gebogen für
die rechte Hand

curved to the left,
for the right hand

courbe à gauche
pour la main droite

curva a la izquierda
para la mano derecha

rechts gebogen für
die linke Hand

curved to the right,
for the left hand

courbe à droite
pour la main gauche

curva a la derecha
para la mano izquierda

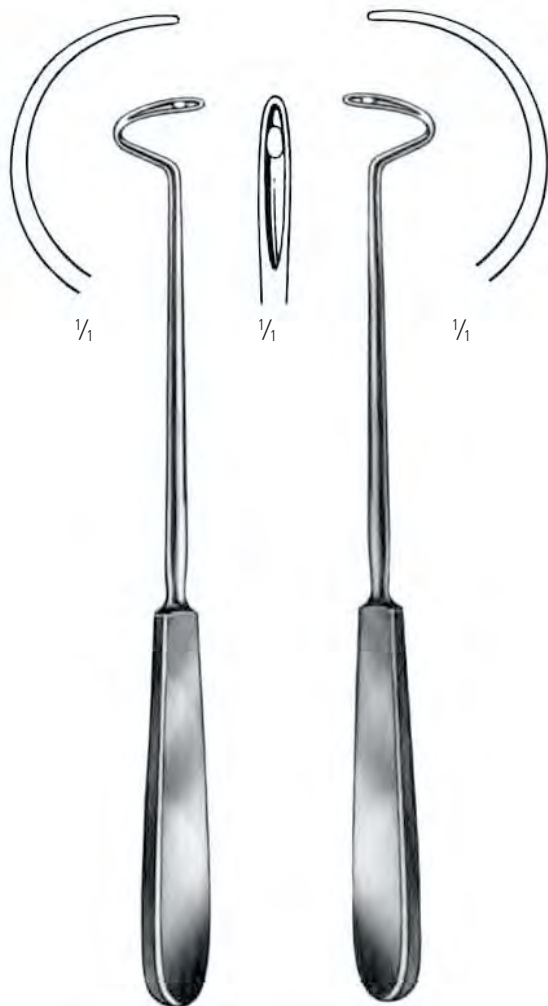

Deschamps
24,0 cm/9½"

12164-1

stumpf
blunt
mousse
roma

Deschamps
24,0 cm/9½"

12164-2

stumpf
blunt
mousse
roma

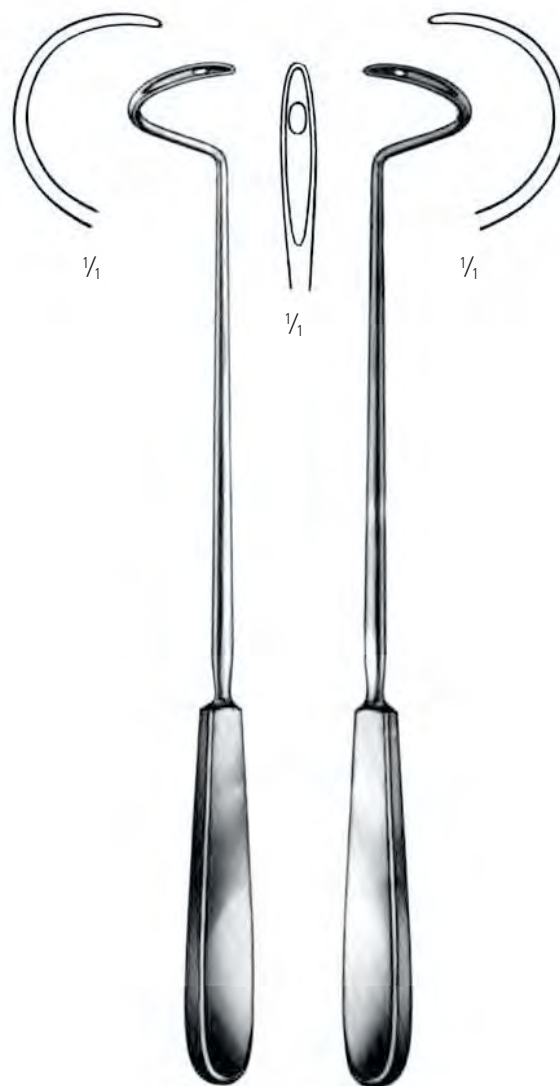

Deschamps
27,0 cm/10½"

12165-1

stumpf
blunt
mousse
roma

Deschamps
24,0 cm/10½"

12165-2

stumpf
blunt
mousse
roma

Unterbindungsnadeln
Ligature Needles
Aiguilles à ligatures
Agujas para ligaduras



SCHWERT
 SWORD · ESPADA
 EPEE · SPADA

links gebogen für
die rechte Hand
 curved to the left,
for the right hand
 courbe à gauche
pour la main droite
 curva a la izquierda
para la mano derecha

rechts gebogen für
die linke Hand
 curved to the right,
for the left hand
 courbe à droite
pour la main gauche
 curva a la derecha
para la mano izquierda

links gebogen für
die rechte Hand
 curved to the left,
for the right hand
 courbe à gauche
pour la main droite
 curva a la izquierda
para la mano derecha

rechts gebogen für
die linke Hand
 curved to the right,
for the left hand
 courbe à droite
pour la main gauche
 curva a la derecha
para la mano izquierda

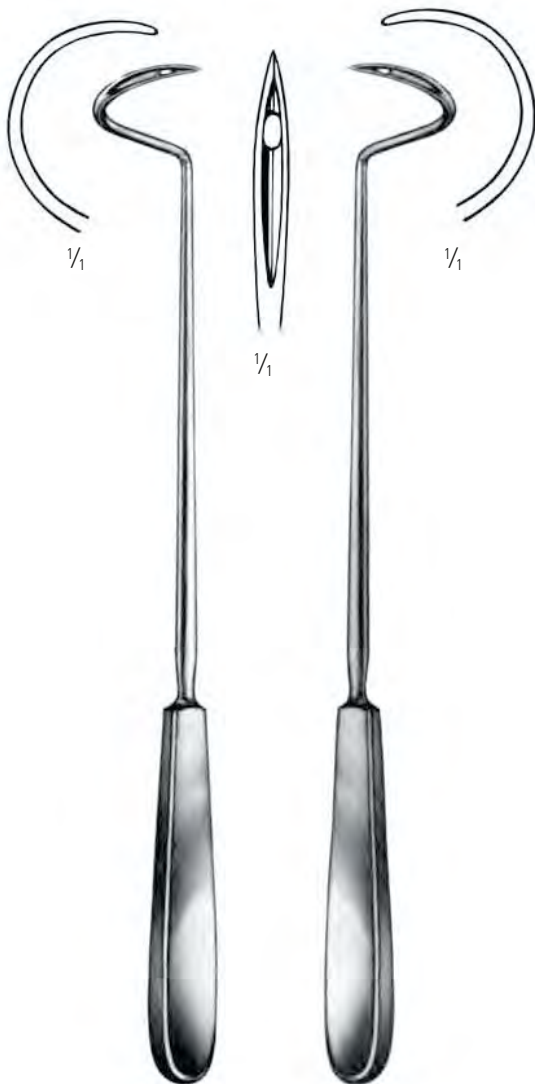

Deschamps
27,0 cm/10½"

12166-1

scharf
sharp
pointue
aguda

Deschamps
27,0 cm/10½"

12166-2

scharf
sharp
pointue
aguda

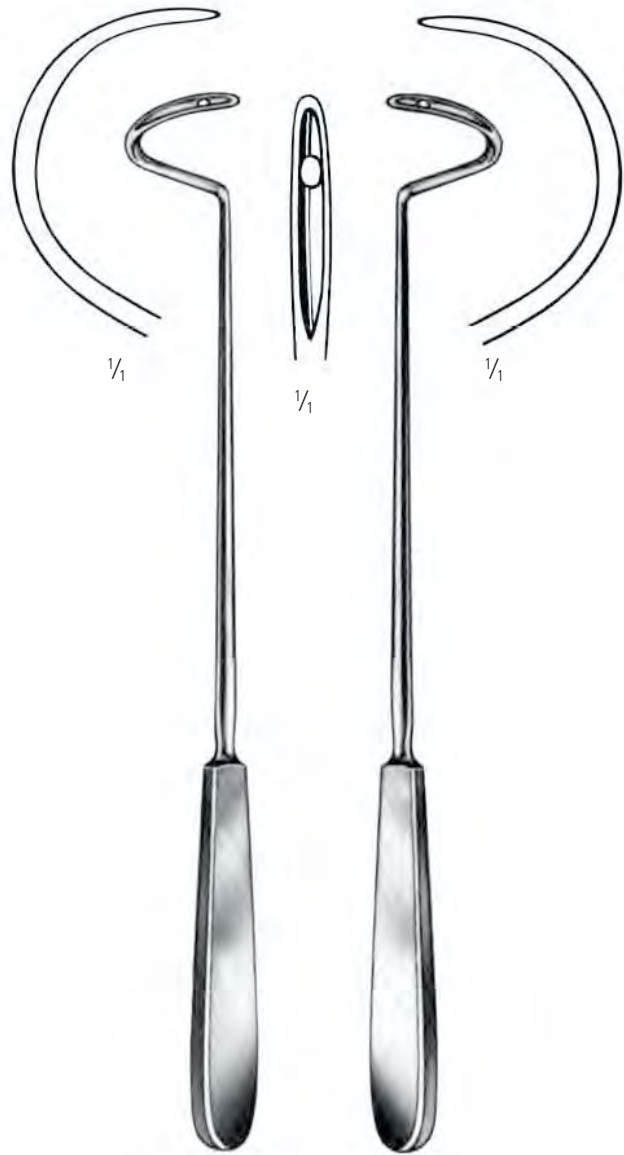

Deschamps
28,0 cm/11"

12167-1

stumpf
blunt
mousse
roma

Deschamps
28,0 cm/11"

12167-2

stumpf
blunt
mousse
roma



SCHWERT
SWORD · ESPADA
EPEE · SPADA

Unterbindungsnadeln Ligature Needles Aiguilles à ligatures Agujas para ligaduras

links gebogen für
die rechte Hand

curved to the left,
for the right hand

courbe à gauche
pour la main droite

curva a la izquierda
para la mano derecha

rechts gebogen für
die linke Hand

curved to the right,
for the left hand

courbe à droite
pour la main gauche

curva a la derecha
para la mano izquierda



Kronecker
13,0 cm/5"

12180-1

Kronecker
13,0 cm/5"

12180-2

Unterbindungsnadeln
Ligature Needles
Aiguilles à ligatures
Agujas para ligaduras



SCHWERT
 SWORD · ESPADA
 EPEE · SPADA

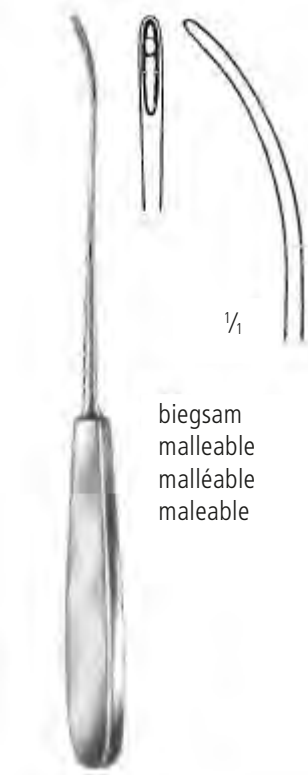

biegsam
 malleable
 malléable
 maleable

12140

20,0 cm/8"

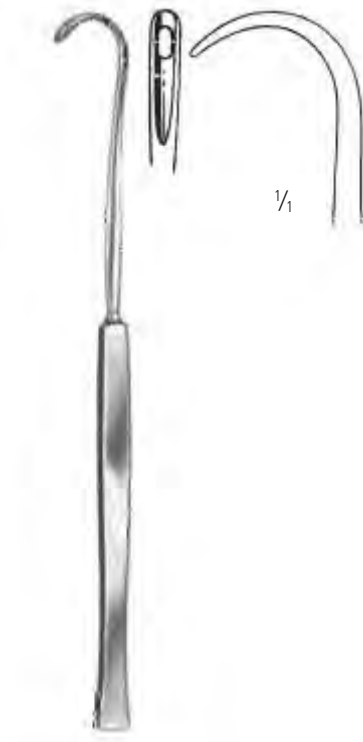

Cooper

12148

19,0 cm/7½"



biegsam
 malleable
 malléable
 maleable

Schmieden-Dick

12141

32,0 cm/12½"



Schmieden

12142

21,0 cm/8¼"



Führungshohlsonden
Ligature Conductors
Sondes conductrices
Sondas conductoras

SCHWERT
SWORD - ESPADA
EPEE - SPADA

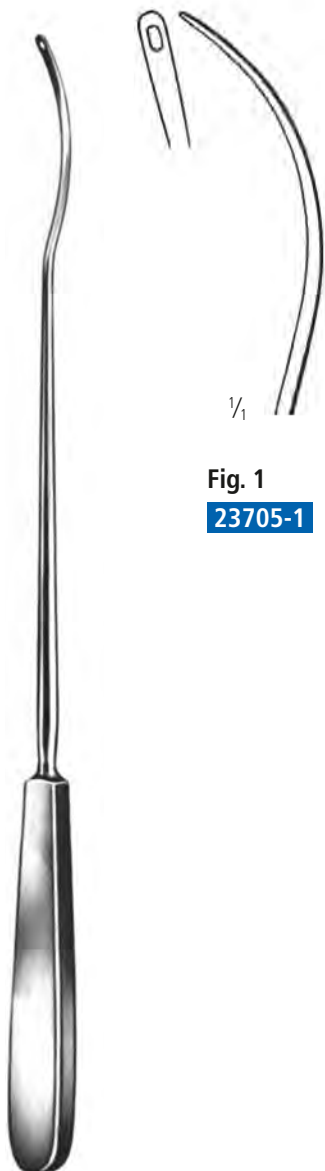

Fig. 1

23705-1



Fig. 2

23705-2



Fig. 3

23705-3



Fig. 4

23705-4

Brunner

30,0 cm/12"

Brunner

30,0 cm/12"

Führungshohlsonden
Ligature Conductors
Sondes conductrices
Sondas conductoras



SCHWERT
SWORD - ESPADA
EPEE - SPADA

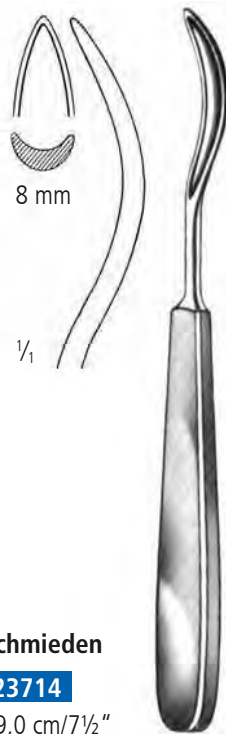

Schmieden

23714

19,0 cm/7½"

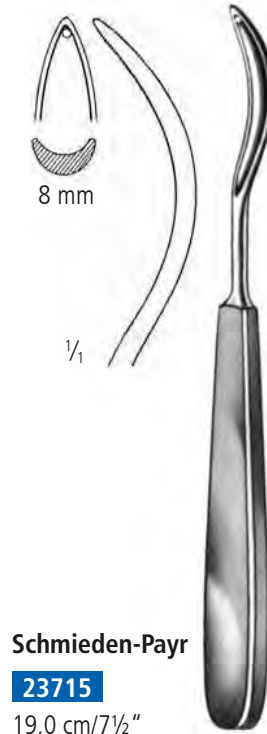

Schmieden-Payr

23715

19,0 cm/7½"

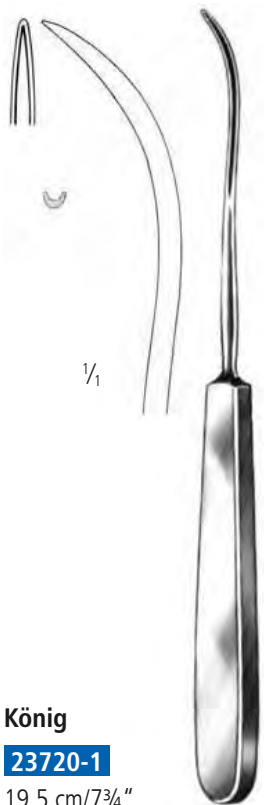

König

23720-1

19,5 cm/7¾"

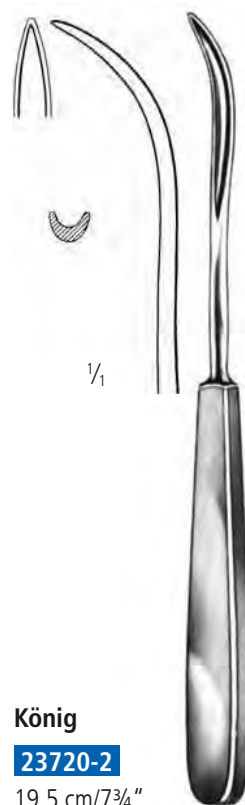

König

23720-2

19,5 cm/7¾"

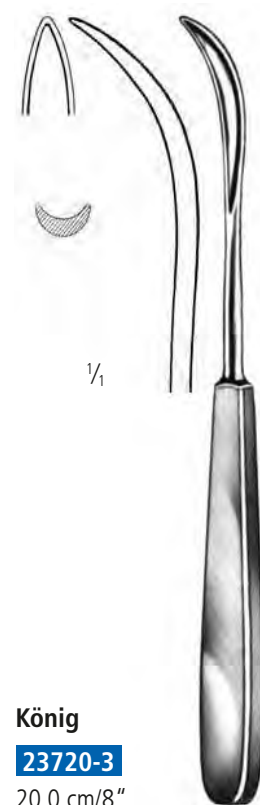

König

23720-3

20,0 cm/8"



SCHWERT
SWORD - ESPADA
EPEE - SPADA

**Führungshohlsonden
Ligature Conductors
Sondes conductrices
Sondas conductoras**



Payr
Fig. 1
24473
22,0 cm/8¾"

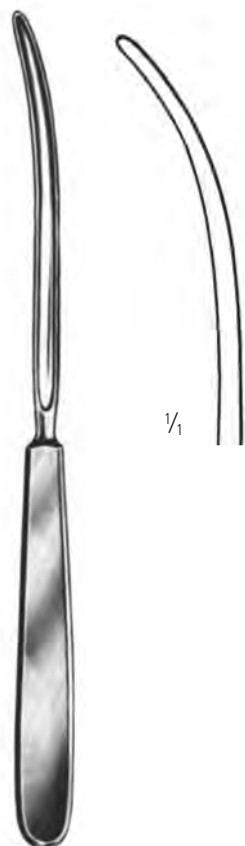

Payr
Fig. 2
24474
22,0 cm/8¾"



24472
19,5 cm/7¾"

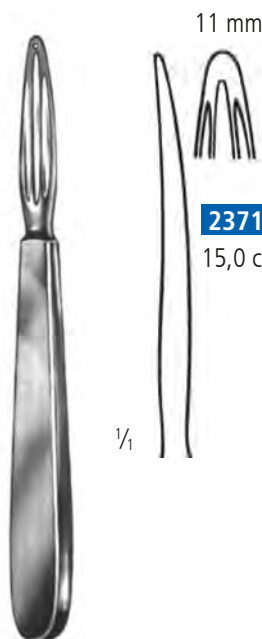

Kocher

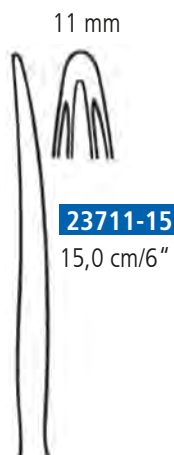

23711-15
15,0 cm/6"

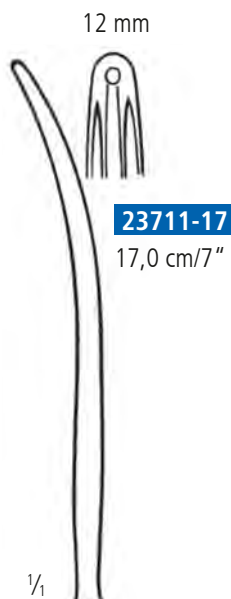

23711-17
17,0 cm/7"

Reverdin-Nadeln
 Reverdin Needles
 Aiguilles de Reverdin
 Aguja de Reverdin



SCHWERT
 SWORD · ESPADA
 EPEE · SPADA



Reverdin
 14,0 cm/5½"



Fig. 1
 12100-1



Fig. 2
 12100-2



Fig. 3
 12100-3



Fig. 4
 12100-4



Reverdin
 19,5 cm/7¾"



Fig. 1
 12104-1



Fig. 2
 12104-2



Fig. 3
 12104-3



Fig. 4
 12104-4



Reverdin-Nadeln
Reverdin Needles
Aiguilles de Reverdin
Agujas de Reverdin

SCHWERT
SWORD · ESPADA
EPEE · SPADA



Reverdin

22,5 cm/8¾"

1/1



Fig. 1

12105-1



Fig. 2

12105-2



Fig. 3

12105-3



Fig. 4

12105-4





SCHWERT
SWORD · ESPADA
EPEE · SPADA

Instrumente mit Hartmetalleinlagen

Instruments with Tungsten Carbide Inserts

Instrumentes avec mors en carbure de tungstène

Instrumentes con placas de carburo tungsteno





SCHWERT
SWORD · ESPADA
EPEE · SPADA

Anatomische Pinzetten mit Hartmetall-Einsätzen
Dressing Forceps with T/C jaws
Pinces à disséquer avec mors en carbure de tungstène
Pinzas de disección con boca de carburo de tungsteno



0,4 mm

1,8 mm



1/2

11307-13
13,0 cm/5"

2,0 mm



1/2

11307-14
14,5 cm/5 1/2"

2,0 mm



1/2

11307-16
16,0 cm/6"

2,0 mm



1/2

11307-18
18,0 cm/7"

2,2 mm



1/2

11307-20
20,0 cm/8"

2,8 mm



1/2

11307-25
25,0 cm/10"

2,8 mm



1/2



11307-30
30,0 cm/12"





Pinzetten mit Hartmetall-Einsätzen
Forceps with T /C jaws
Pincas avec morsen carbure de tungstène
Pinzas con boca de carburo de tungsteno



SCHWERT
 SWORD · ESPADA
 EPEE · SPADA

1,6 mm 1,6 mm
 $\frac{1}{1}$  $\frac{1}{1}$
11399-12 **11399-15**
 12,0 cm/4 $\frac{3}{4}$ " 15,0 cm/6"

1,6 mm 1,6 mm
 $\frac{1}{1}$  $\frac{1}{1}$
11401-12 **11401-15**
 12,0 cm/4 $\frac{3}{4}$ " 15,0 cm/6"
Adson

18,0 cm = 1,8 mm
 21,0 cm = 2,0 mm
 25,0 cm = 2,5 mm





Potts-Smith

11441-18 18,0 cm/7"
11441-20 21,0 cm/8 $\frac{1}{4}$ "
11441-25 25,0 cm/10"

1,8 mm
 $\frac{1}{1}$
11474 17,5 cm/7"
 gerade, straight
 droit, rectas



 $\frac{1}{1}$
11475 17,5 cm/7"
 abgewinkelt, angular
 coudeé, angulares

Cushing

 $\frac{1}{1}$  $\frac{1}{1}$  $\frac{1}{1}$
11359-14 **11359-16** **11359-18**
 14,0 cm/5 $\frac{1}{2}$ " 16,0 cm/6 $\frac{1}{2}$ " 18,0 cm/7"

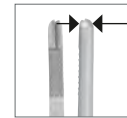
11490-10 = 1,5 mm
11490-15 = 2,0 mm



 $\frac{1}{1}$  $\frac{1}{1}$
11359-20 **11359-25**
 20,0 cm/8" 25,0 cm/10"

 $\frac{1}{1}$
11454
 gerieft
 serrated
 strie
 estriada

 $\frac{1}{1}$
11456
 1x2 Zähne
 1x2 teeth
 1x2 dents
 1x2 dientes

Chir. Pinzette

Gerald

17,0 cm/6 $\frac{3}{4}$ "

Wangensteen

5,5 mm
 $\frac{1}{1}$
11480-23
 15,0 cm/6"

4,5 mm
 $\frac{1}{1}$
11480-15
 15,0 cm/6"



DeBakey

11490-10
11490-15
 15,0 cm/6"



SCHWERT
SWORD · ESPADA
EPEE · SPADA

Technische Hinweise für Hartmetalleinsätze Technical indications for tungsten carbide inserts Indications techniques pour mors en carbure de tungstène Indicación técnica para bocas de carburo de tungsteno

i

Hartmetalleinsätze

Um den besonderen anwendungsbedingten Bedürfnissen zu entsprechen, sind Hartmetall-Einlagen in 3 Profilgrößen und in glatter Ausführung erhältlich:

- Standard (0,5 mm)
- Fein (0,4 mm)
- Micro (0,3 mm)

Somit können Chirurgen für alle Operationsbereiche mit unterschiedlichsten Nadelstärken, Instrumente von optimaler Griffigkeit angeboten werden. Das pyramidenförmig eingeschliffene Zahnprofil sorgt auch in extremen Situationen für sicheren Halt. Um Ihnen einen Überblick über die Verwendung der einzelnen HM-Plättchen zu geben, haben wir jeweils bei der Nebenzeichnung die Zahnteilung in mm angegeben.

Tungsten Carbide Inserts

In order to conform to the special different requirements, the tungsten carbide inserts are available in 3 profile sizes and smooth finish:

- standard (0.5 mm)
- fine (0.4 mm),
- micro (0.3 mm).

So its possible to offer the surgeon instruments with an optimal touch with a different needle thickness for all operation fields. The pyramidal ground tooth profile offers a sure handhold even in extreme situations. In order to give you a general view about the use of the single tungsten carbide inserts, we indicated the tooth pitch at each sketch in mm.

Mors en carbure de tungstène

Pour répondre aux besoins particuliers de certaines applications, les inserts avec mors en carbure de tungstène sont commercialisés en 3 grosseurs de profil, ainsi qu'en finition lisse :

- standard (0,5 mm)
- fin (0,4 mm),
- micro (0,3 mm)

Ceci permet aux chirurgiens de disposer des instruments d'une adhérence optimale dans tous les domaines d'opération et pour les différentes solidités d'aiguille. Le profil de dent aiguisé pyramidalement garantit une tenue en main sécurisée même dans des situations extrêmes. Pour vous donner une vue d'ensemble sur l'emploi des différents inserts en carbure de tungstène, nous avons indiqué pour chaque ébauche le pas d'engrenage en mm.

Bocas de carburo de tungsteno

Para los especiales uso de empleo y poder corresponder a los grandes necesidades, son los bocas de carburo de tungsteno en 3 tamaños y de contrucción lisa.

- standard (0,5 mm)
- fino (0,4 mm),
- micro (0,3 mm)

Así los cirurgicos pueden alcanzar todos clases de operaciones con diversos gruesos de agujas, ofrecemos instrumentos de optimal agarre. La forma piramidal del perfil dental afilado sirve también para el apoyo seguro en extremos situaciones. Para darles a ustedes una vista sobre el uso de empleo de los diferentes bocas de carburo de tungsteno al respecto, hemos detallado en el dibujo del lado abajo adjunto en mm.

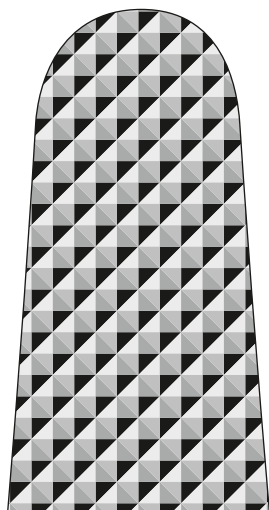

0,5 mm / TC5

Standard
2500 teeth per sq. in.

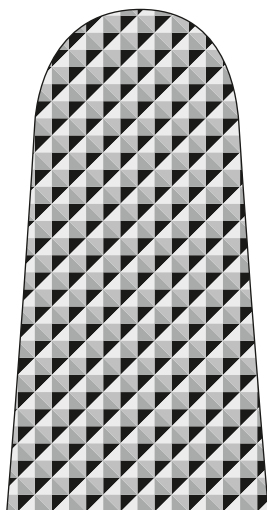

0,4 mm / TC4

Fein · fine · fin · fino
3600 teeth per sq. in.

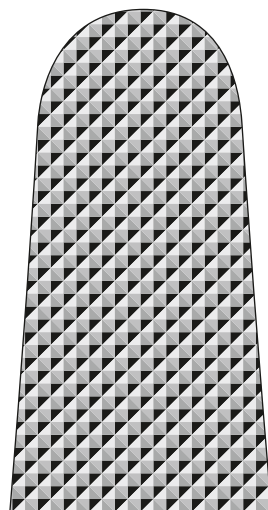

0,3 mm / TC3

Micro
7200 teeth per sq. in.

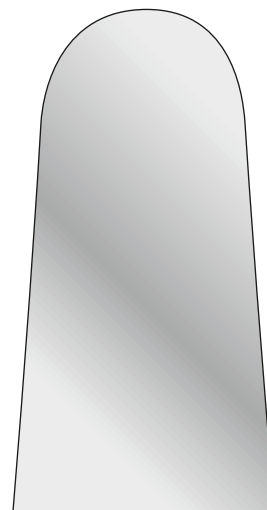

glatt · smooth · lisse · lisa



Technische Hinweise für Hartmetalleinsätze
Technical indications for tungsten carbide inserts
Indications techniques pour mors en carbure de tungstène
Indicación técnica para bocas de carburo de tungsteno



SCHWERT
 SWORD · ESPADA
 EPEE · SPADA

i

Die Griffigkeit

Durch Hartmetall-Einlagen behält das Instrument seine wichtigste funktionelle Eigenschaft.

Die ungewöhnliche Härte des Einlagenmaterials ergibt sich aus seiner besonderen Zusammensetzung:

- 87,5-88% Wolframkarbid
- 12% Nickel
- 0-0,5% Chromkarbid

Die mit diesem Werkstoff erreichte Abriebs- und Verformungsfestigkeit des Zahnprofils, sorgt so für die lange Gebrauchsfähigkeit des Instruments.

Wir empfehlen Hartmetall-Maulteile

- mit glatter Fläche für Nahtmaterial 9/0-11/0
- mit Teilung **0,3 mm / TC3** für Nahtmaterial 6/0-10/0
- mit Teilung **0,4 mm / TC4** für Nahtmaterial 4/0-6/0
- mit Teilung **0,5 mm / TC5** für Nahtmaterial bis 3/0

The Touch

As a result of TC inserts, the instrument keeps its most important functional characteristic.

The unusual hardness of the insert material is reason of its special composition:

- 87,5-88% Wolfram Carbide
- 12% Nickel
- 0-0,5% Chrome Carbide

The rubbing- and deformation solidity of the tooth profile, obtained by this material, takes care for the long use of instrument.

We recommend carbide inserts

- with smooth jaw surface for suture material 9/0-11/0
- with **0.3 mm / TC3** pitch of serration for suture material 6/0-10/0
- with **0.4 mm / TC4** pitch of serration for suture material 4/0-6/0
- with **0.5 mm / TC5** pitch of serration for suture material up to 3/0

L'adhérence

Grâce aux inserts en carbure de tungstène, l'instrument garde son caractère le plus fonctionnelle.

La dureté extraordinaire du matériel résulte de sa composition particulière :

- 87.5-88% Tungstène-carbure
- 12% Nickel
- 0-0.5% Carbure de chrome

La résistance contre l'usure et la déformation, atteinte par ce matériel, assure une très grande longévité de l'instrument.

Nous recommandons des mors en carbure de tungstène

- avec mâchoires lisses pour matériels de suture 9/0-11/0
- avec pas d'engrenage **0,3 mm / TC3** pour matériels de suture 6/0-10/0
- avec pas d'engrenage **0,4 mm / TC4** pour matériels de suture 4/0-6/0
- avec pas d'engrenage **0,5 mm / TC5** pour matériels de suture jusqu'à 3/0

El buen agarre

Por bocas de carburo de tungsteno conserva el instrumento su función de importante calidad.

La extraordinaria dureza del material de este instrumento se lo da por su bien ajuste:

- 87,5-88% Carburo de wolframio
- 12% Níquel
- 0-0,5% Carburo de cromo

Con esta clase de material alcanza una dureza contra restrega y peridura del perfil dental, asimismo cuida para la largamantenición del instrumento.

Recomendamos las bocas de metal duro

- con superficie lisa para material de sutura con paso 9/0-11/0
- con paso **0,3 mm / TC3** paramaterial de sutura 6/0-10/0
- con paso **0,4 mm / TC4** para material de sutura 4/0-6/0
- con paso **0,5 mm / TC5** para material de sutura hasta 3/0





SCHWERT
SWORD · ESPADA
EPEE · SPADA

Augennadelhalter mit Hartmetall-Einsätzen

Eye needle holders with T/C jaws

Porte-aiguilles pour les yeux avec mors en carbure de tungstène

Porta-agujas para ojos con boca de carburo de tungsteno

ohne Sperre, without ratchet
sans crémaillère, sin cremallera



12350-14

gerade
straight
droite
recta

14,0 cm/5½"



12351-14

gebogen
curved
courbe
curva



TC3

12352-14

gerade
straight
droite
recta

14,0 cm/5½"



TC3

12353-14

gebogen
curved
courbe
curva



Castroviejo

mit Sperre, with ratchet
avec crémaillère, con cremallera



12356-14

gerade
straight
droite
recta

14,0 cm/5½"

12356-18

18,0 cm/7"

12356-21

21,0 cm/8¼"



12357-14

gebogen
curved
courbe
curva

12357-18

12357-21



TC3

12358-14

gerade
straight
droite
recta

14,0 cm/5½"

12358-18

18,0 cm/7"

12358-21

21,0 cm/8¼"



TC3

12359-14

gebogen
curved
courbe
curva

12359-18

12359-21



Kalt

12365-14

14,0 cm/5½"

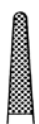

TC3

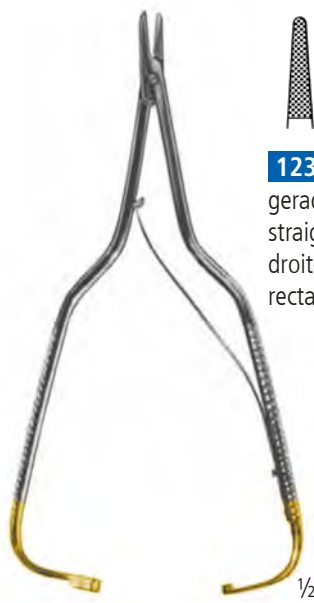

Arruga

16,0 cm/6¼"



TC3

12370-16

gerade
straight
droite
recta



TC3

12371-16

gebogen
curved
courbe
curva



Barraquer

13,5 cm/5¼"

TC3

12374-13

gerade
straight
droite
recta

12375-13

gebogen
curved
courbe
curva

Nadelhalter mit Hartmetall-Einsätzen
Needle holders with T/C jaws
Porte-aiguilles avec mors en carbure de tungstène
Porta-agujas con boca de carburo de tungsteno



SCHWERT
 SWORD · ESPADA
 EPEE · SPADA

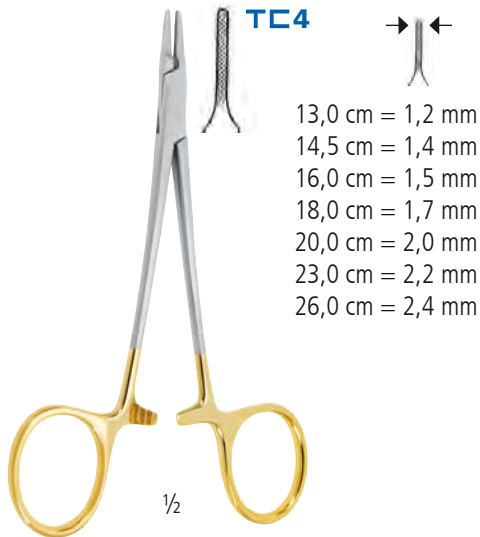

13,0 cm = 1,2 mm
 14,5 cm = 1,4 mm
 16,0 cm = 1,5 mm
 18,0 cm = 1,7 mm
 20,0 cm = 2,0 mm
 23,0 cm = 2,2 mm
 26,0 cm = 2,4 mm

French

- 12488-13** 13,0 cm/5"
- 12488-15** 14,5 cm/5½"
- 12488-16** 16,0 cm/6¼"
- 12488-18** 18,0 cm/7"
- 12488-20** 20,0 cm/8"
- 12488-23** 23,0 cm/9"
- 12488-26** 26,0 cm/10¼"



Derf

- 12431** 12,5 cm/5"



Mayo-Hegar

- 12452-30** 30,0 cm/12"

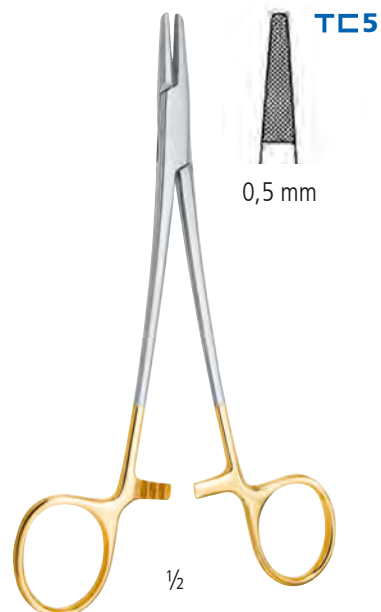

Mayo-Hegar

- 12452-14** 14,5 cm/5½"
- 12452-16** 16,0 cm/6¼"
- 12452-18** 18,0 cm/7¼"
- 12452-20** 20,0 cm/8"
- 12452-23** 23,0 cm/9"
- 12452-26** 26,0 cm/10¼"



SCHWERT
SWORD · ESPADA
EPEE · SPADA

Nadelhalter mit Hartmetall-Einsätzen
Needle holders with T/C jaws
Porte-aiguilles avec mors en carbure de tungstène
Porta-agujas con boca de carburo de tungsteno



kräftige Ausführung
heavy pattern
modèle robuste
de fuerte construcción

Hegar

12453-20

20,0 cm/8"

12453-24

24,0 cm/9½"



Olsen-Hegar

11629-14

14,0 cm/5½"

11629-16

16,0 cm/6¼"



Olsen-Hegar

11629-17

17,0 cm/6¼"



Olsen-Hegar

11629-18

18,0 cm/7"

Nadelhalter mit Hartmetall-Einsätzen
Needle holders with T/C jaws
Porte-aiguilles avec mors en carbure de tungstène
Porta-agujas con boca de carburo de tungsteno



SCHWERT
 SWORD · ESPADA
 EPEE · SPADA



Wangensteen

12465 27,0 cm/10½"



Finochietto

12472-20 20,0 cm/8"
12472-26 26,0 cm/10¼"



Baumgartner

12438 13,0 cm/5"



Crile-Wood

12436-15 15,0 cm/6"
12436-18 18,0 cm/7"
12436-20 20,0 cm/8"
12436-23 23,0 cm/9"
12436-26 26,0 cm/10¼"

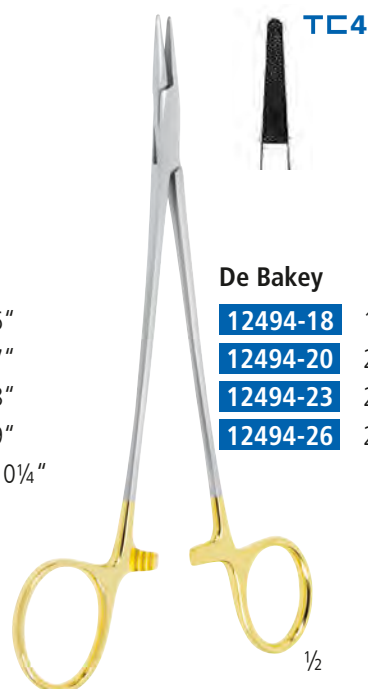

De Bakey

12494-18 18,0 cm/7"
12494-20 20,0 cm/8"
12494-23 23,0 cm/9"
12494-26 26,0 cm/10¼"



SCHWERT
SWORD - ESPADA
EPEE - SPADA

Nadelhalter mit Hartmetall-Einsätzen
Needle holders with T/C jaws
Porte-aiguilles avec mors en carbure de tungstène
Porta-agujas con boca de carburo de tungsteno



Heaney

12455-20 20,0 cm/8"

12455-26 26,0 cm/10 1/4"

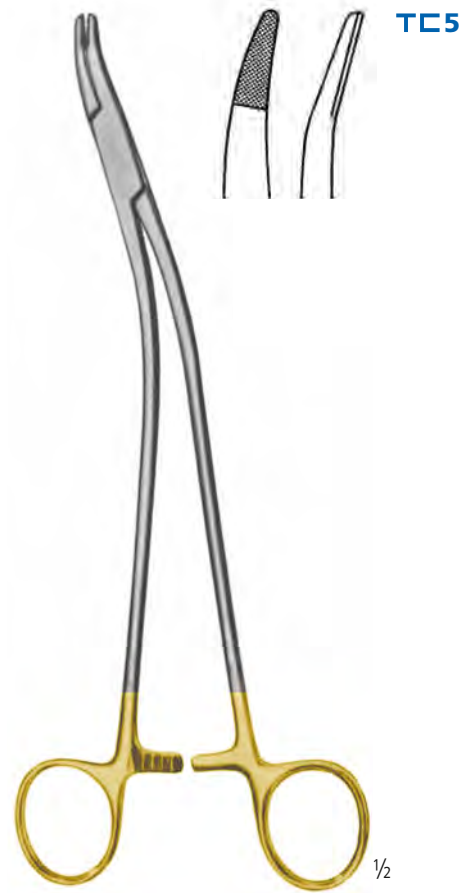

Stratte

12473-23 23,0 cm/9"



Mathieu

12508-14 14,0 cm/5 1/2"

12508-17 17,0 cm/6 1/2"

12508-20 20,0 cm/8"



Halsey

13,0 cm/5"

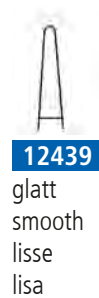

12439-1

12439

glatt
smooth
lisse
lisa



Webster

12439-5 13,0 cm/5"

Nadelhalter mit Hartmetall-Einsätzen
Needle holders with T/C jaws
Porte-aiguilles avec mors en carbure de tungstène
Porta-agujas con boca de carburo de tungsteno



SCHWERT
 SWORD · ESPADA
 EPEE · SPADA



Mathieu

12510-17 17,0 cm/6½"
12510-20 20,0 cm/8"



Mathieu

12511-17 17,0 cm/6½"
12511-20 20,0 cm/8"

kräftige Ausführung
 heavy pattern
 modele robuste
 de fuerte construcción

für den Veterinär-Bereich
 for the veterinary field
 pour des vétérinaires
 para los veterinarios



French-Mathieu

12514-14 14,0 cm/5½"
12514-17 17,0 cm/6½"
12514-20 20,0 cm/8"



Mathieu

12509-14 14,0 cm/5½"
12509-17 17,0 cm/6½"
12509-20 20,0 cm/8"

schmales Modell
 delicate pattern
 modèle étroit
 modelo estrecho

gebogenes Modell
 curved pattern
 modèle courbe
 modelo curvo



SCHWERT
SWORD · ESPADA
EPEE · SPADA

Nadelhalter mit Hartmetall-Einsätzen
Needle holders with T/C jaws
Porte-aiguilles avec mors en carbure de tungstène
Porta-agujas con boca de carburo de tungsteno



Sarat

- 12520-18** 18,0 cm/7"
- 12520-20** 20,0 cm/8"
- 12520-26** 26,0 cm/10¼"



Masson

- 12511-27** 27,0 cm/10½"



Olsen-Hegar

- 11630-14** 14,0 cm/5½"

kräftige Ausführung
heavy pattern
modele robuste
de fuerte construcción

für den Veterinär-Bereich
for the veterinary field
pour des vétérinaires
para los veterinarios



Olsen-Hegar

- 11630-17** 17,0 cm/6¾"

Nadelhalter mit Hartmetall-Einsätzen
Needle holders with T/C jaws
Porte-aiguilles avec mors en carbure de tungstène
Porta-agujas con boca de carburo de tungsteno



SCHWERT
 SWORD · ESPADA
 EPEE · SPADA



Kilner

12423 13,0 cm/5"



Baby-Olsen-Hegar

11,5 cm/4 1/2"

11631-11 **11631-21**

gerieft
 serrated
 striée
 estriada

glatt
 smooth
 lisse
 lisa

für sehr feine Nadeln
 for fine needles
 pour des aiguilles tres fines
 para agujas finas



Bozemann

12484-20 20,0 cm/8"

12484-23 24,0 cm/9 1/2"

12484-26 26,0 cm/10 1/4"

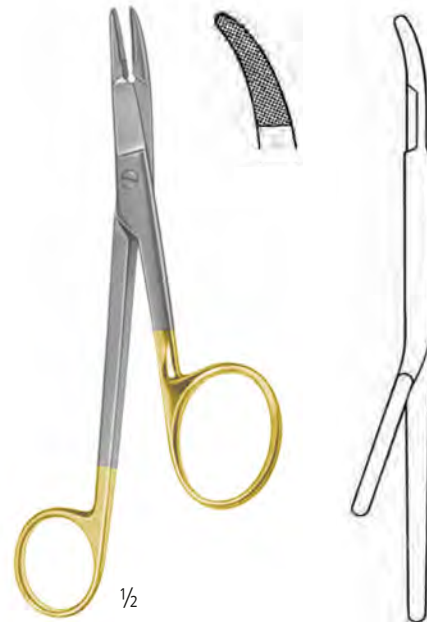

Gillies-Baby

11626-11 **TC3** 11,0 cm/4"

Gillies

11626-16 **TC5** 16,0 cm/6 1/4"



SCHWERT
SWORD · ESPADA
EPEE · SPADA

Gewebefasszangen mit Hartmetall-Einsätzen
Tissue Seizing Forceps with T/C jaws
Pinces a saisir les tissus avec mors en carbure de tungstène
Pinzas para coger tejidos con boca de carburo de tungsteno



Gewebefasszange
Tissue Seizing Forceps
Pince à saisir les tissus
Pinza para coger tejidos

Duval

16831-20 20,0 cm/8"



Babcock

16845-16 16,0 cm/6¼"

16845-20 20,0 cm/8"



Allis

13744-16 16,0 cm/6¼"

13744-19 19,0 cm/7½"

Scheren mit Hartmetall-Schneiden
 Scissors with tungsten carbide edges
 Ciseaux avec tranchants en carbure de tungstène
 Tijeras con cortantes de carburo de tungsteno



SCHWERT
 SWORD · ESPADA
 EPEE · SPADA



Standard
 14,5 cm/5½"



Standard
 14,5 cm/5½"



Fig. 1
11552-A14



Fig. 2
11552-B14



Fig. 3
11552-C14

gerade
 straight
 droits
 rectas

gebogen
 curved
 courbes
 curvas

11553-A14

11553-B14

11553-C14



Parametrium



26730-1
 22,5 cm/9"



26730-2
 23,0 cm/9"



Lister
11677-18
 18,0 cm/7"



SCHWERT
SWORD - ESPADA
EPEE - SPADA

Scheren mit Hartmetall-Schneiden
Scissors with tungsten carbide edges
Ciseaux avec tranchants en carbure de tungstène
Tijeras con cortantes de carburo de tungsteno



Mayo

11556-14 14,5 cm/5½"
11556-17 17,0 cm/6¾"

11557-14
11557-17



Mayo-Stille

11564-15 15,0 cm/6"
11564-17 17,0 cm/6¾"

11565-15
11565-17



Mayo-Lexer
16,5 cm/6½"

11566-16
gerade
straight
droite
recta

11567-16
gebogen
curved
courbe
curva



Strabismus (Metzenbaum)
11,5 cm/4½"

11582-11

11583-11

Scheren mit Hartmetall-Schneiden
 Scissors with tungsten carbide edges
 Ciseaux avec tranchants en carbure de tungstène
 Tijeras con cortantes de carburo de tungsteno



SCHWERT
 SWORD · ESPADA
 EPEE · SPADA

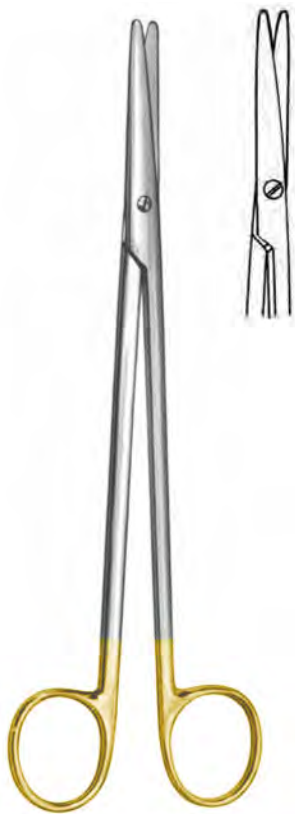

1/2

Metzenbaum

- | | |
|-----------------|-------------|
| 11582-14 | 14,5 cm/5½" |
| 11582-18 | 18,0 cm/7" |
| 11582-20 | 20,0 cm/8" |
| 11582-23 | 23,0 cm/9" |



- | | |
|-----------------|--|
| 11583-14 | |
| 11583-18 | |
| 11583-20 | |
| 11583-23 | |



1/2

Irischere

11,5 cm/4¾"



11612

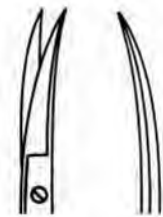

11613



1/2

Metzenbaum, Fino

- | | |
|-----------------|-------------|
| 11584-14 | 14,5 cm/5½" |
| 11584-18 | 18,0 cm/7" |
| 11584-20 | 20,0 cm/8" |
| 11584-23 | 23,0 cm/9" |



- | | |
|-----------------|--|
| 11585-14 | |
| 11585-18 | |
| 11585-20 | |
| 11585-23 | |



1/2

Tönnis-Adson

- | | |
|--------------|------------|
| 11587 | 17,0 cm/7" |
|--------------|------------|



SCHWERT
SWORD - ESPADA
EPEE - SPADA

Drahtkneifzangen mit Hartmetall-Einlagen
Wire and pin cutters with tungsten carbide inserts
Pinces à couper le fil avec mors en carbure de tungstène
Alicates para cortar alambre con boca de carburo de tungsteno



gezahnte Schneide
saw edge
lame de scie
corte con dientes

Universal

14146 12,0 cm/5"



14136-12 12,5 cm/5"



14157-18 17,5 cm/7"

für Drähte bis 1,6 mm Ø
for wires up to 1.6 mm Ø
pour fils jusqu'a 1,6 mm Ø
para hilos hasta 1,6 mm Ø



14157-22 22,0 cm/8¾"

für Drähte bis 2,5 mm Ø
for wires up to 2.5 mm Ø
pour fils jusqu'a 2,5 mm Ø
para hilos hasta 2,5 mm Ø

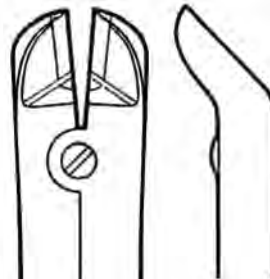

14157-16 16,0 cm/6½"

für Drähte bis 1,6 mm Ø
for wires up to 1.6 mm Ø
pour fils jusqu'a 1,6 mm Ø
para hilos hasta 1,6 mm Ø

Drahtkniefzangen mit Hartmetall-Einlagen
Wire and pin cutters with tungsten carbide inserts
Pinces à couper le fil avec mors en carbure de tungstène
Alicates para cortar alambre con boca de carburo de tungsteno



SCHWERT
 SWORD · ESPADA
 EPEE · SPADA



18,0 cm/7"



Fig. 1

14127-2



Fig. 2

14127-3



Fig. 3

14127-6

Drahtspannzangen
Wire Twisting Forceps
Pinces pour ligatures de fil
Pinzas para torcer hilos



14161 18,0 cm/7"

für weiche Drähte bis 2,0 mm Ø
 for soft wires up to 2.0 mm Ø
 pour fils mous jusqu'a 2,0 mm Ø
 para hilos blandos hasta 2,0 mm Ø

für harte Drähte bis 1,7 mm Ø
 for hard wires up to 1.7 mm Ø
 pour fils durs jusqu'a 1,7 mm Ø
 para hilos duros hasta 1,7 mm Ø



14165-16 16,0 cm/6½"

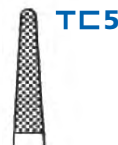

TC5



12459 18,0 cm/7"



TC5



SCHWERT
SWORD · ESPADA
EPEE · SPADA

Drahtschneidezangen mit extraharten Einsätzen Wire cutters with extra hard cutting edges Pincès à couper le fil avec mors en material extra-dur Pinzas cortantes p. alambres con bocas extra duro

Rostfrei – sterilisierbar
stainless steel – sterilizeable
En acier inoxydable – à stériliser
De acero inoxidable – esterilizabile



- max. 0,2 mm
harte Drähte / hard wires
fils durs / hilos duros
- max. 0,4 mm
weiche Drähte / soft wires
fils mous / hilos blandos

14138 11,0 cm/4½"



- max. 0,5 mm
- max. 0,5 mm
harte Drähte / hard wires
fils durs / hilos duros

14140 14,0 cm/5½"



- max. 0,5 mm
harte Drähte / hard wires
fils durs / hilos duros

14139 12,5 cm/5"



SCHWERT
SWORD · ESPADA
EPEE · SPADA

Messer, Skalpel Knives, Scalpels Couteaux, Bistouris Cuchillos, Bisturías

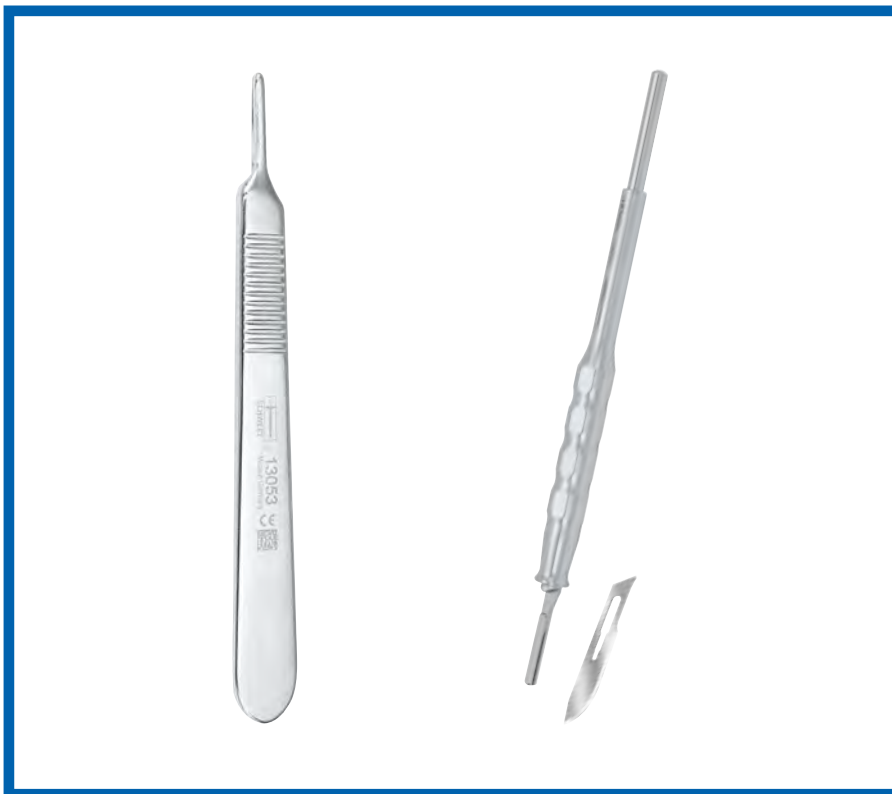



SCHWERT
SWORD · ESPADA
EPEE · SPADA

Skalpelle-Griffe
Scalpel Handles
Manches pour bistouris
Mangos de bisturías

SAFE-EX 2

patented



1:1

13051

Sicherheitsklingenhalter,
ergonomische Form,
zerlegbar
Safety blade holder,
ergonomic shape,
dismountable



**Nie wieder
Verletzungen
Never again
injuries**

i

SAFE-EX

Das alltägliche Verletzungsrisiko beim Aufnehmen und vor allem dem Entfernen der Klinge vom Skalpell Griff ist mit herkömmlichen Instrumenten unvermeidlich. Mit dem neuen SCHWERT SAFE-EX hat man eine Innovation geschaffen die den Praxisalltag verändert. Die im Griff integrierte Funktion, ähnlich der Benutzung eines Kugelschreibers, reduziert die Verletzungsgefahr auf ein Minimum. Die Klinge wird beim SAFE-EX per Knopfdruck am distalen Ende einfach ausgeworfen. Praxispersonal wird im Zuge der Wiederaufbereitung wirksam vor Krankheitsübertragungen und Infektionen durch Schnitte geschützt.

SAFE-EX

The daily risk of injuries by mounting and especially dismantling of blades is not avoidable by standard blade holders. With the new SCHWERT SAFE-EX an innovation was developed that changes the daily routine eminently. The integrated function that works like a regular ball pen reduces the risk of an injury to a minimum. The blade is ejected from the SAFE-EX just by pushing the button on the distal end. The practice staff, especially during the re-processing, is safe from infections caused by unintended cuts.

Skalpelli-Griffe
 Scalpel Handles
 Manches pour bistouris
 Mangos de bisturías

1:1



Standard

13053

No. 3
 massiv
 solid
 massif
 macizo

13053-L

No. 3L
 massiv
 solid
 massif
 macizo

13053-LA

No. 3L
 massiv, abgewinkelt
 solid, angular
 massif, coudé
 macizo, acodado

Standard

13054

No. 4
 massiv
 solid
 massif
 macizo

13054-L

No. 4L
 massiv
 solid
 massif
 macizo

13054-LA

No. 4L
 massiv, abgewinkelt
 solid, angular
 massif, coudé
 macizo, acodado



SCHWERT
 SWORD · ESPADA
 EPEE · SPADA



SCHWERT
SWORD · ESPADA
EPEE · SPADA

Skalpell-Griffe
Scalpel Handles
Manches pour bistouris
Mangos de bisturías

1:1

Skalpell-Griffe
Scalpel Handles
Manches pour bistouris
Mangos de bisturías



Standard

13057

No. 7
massiv
solid
massif
macizo



13057-K

No. 7K
massiv
solid
massif
macizo



13058

No. 8
hohl
hollow
creux
hueco



13059

No. 9
hohl
hollow
creux
hueco

Skalpellsklingen
 Scalpel Blades
 Lames pour bistouris
 Hojas de bisturías



SCHWERT
 SWORD · ESPADA
 EPEE · SPADA

steril
 sterile
 stériles
 estériles



Fig. 10
Standard
13066-10



Fig. 11
Standard
13066-11



Fig. 12
Standard
13066-12



Fig. 13
Standard
13066-13

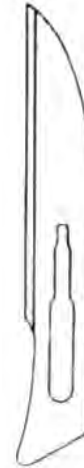

Fig. 14
Standard
13066-14



Fig. 15
Standard
13066-15

steril
 sterile
 stériles
 estériles

Verkaufseinheit: Pack à 100 Stück
 Sales unit: Package of 100 pieces
 Quantite de vente : Paquet de 100 pièces
 Unidad de venta: Paquete de 100 piezas



Fig. 16
Standard
13066-16



Fig. 17
Standard
13066-17



Skalpellklingen
Scalpel Blades
Lames pour bistouris
Hojas de bisturías

SCHWERT
SWORD · ESPADA
EPEE · SPADA

steril
sterile
stériles
estériles



Fig. 18
Standard

13067-18



Fig. 19
Standard

13067-19



Fig. 20
Standard

13067-20



Fig. 21
Standard

13067-21



Fig. 22
Standard

13067-22



Fig. 23
Standard

13067-23

steril
sterile
stériles
estériles



Fig. 24
Standard

13067-24



Fig. 25
Standard

13067-25



Fig. 34
Standard

13067-34

Verkaufseinheit: Pack à 100 Stück
Sales unit: Package of 100 pieces
Quantité de vente : Paquet de 100 pièces
Unidad de venta: Paquete de 100 piezas



SCHWERT
SWORD · ESPADA
EPEE · SPADA

Verschiedene Klemmen

Miscellaneous Forceps

Pinces diverses

Pinzas diversas





SCHWERT
SWORD · ESPADA
EPEE · SPADA

Bulldog klemmen
Bulldog Clamps
Clamps Bulldog
Clamps Bulldog

Arterienklemmen
Hemostatic Forceps
Pincès hémostatiques
Pinzas hemostáticas



Dieffenbach
6,0 cm/2½"

13864 **13865**



Dieffenbach
3,5 cm/1½"

13866-3 **13867-3**
5,0 cm/2"
13866-5 **13867-5**



John Hopkins

17517-2 5,0 cm/2"
17517-4 6,5 cm/2½"
17517-6 7,5 cm/3"

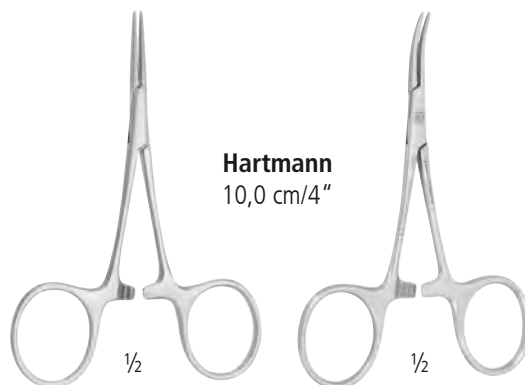

Hartmann
10,0 cm/4"

13840-5 micro **13841-5** micro
13840 **13841**



atraumatisch
atraumatic
atraumatique
atraumàtica



Glover

17526-6 6,0 cm/2½" **17526-7** 7,0 cm/3" **17526-9** 9,0 cm/3½" **17526-10** 10,5 cm/4"
17527-5 5,5 cm/2" **17527-6** 6,5 cm/2½" **17527-8** 8,5 cm/3½" **17527-10** 10,0 cm/4"

Arterienklemmen
Hemostatic Forceps
Pincés hémostatiques
Pinzas hemostáticas



SCHWERT
SWORD · ESPADA
EPEE · SPADA



Halsted-
Mosquito

1/2

13600

12,5 cm/5"

13600-14

14,0 cm/5 1/2"

13606 micro

12,5 cm/5"

gerade
straight
droits
rectas



1/2

13601

13601-14

13607 micro

gebogen
curved
courbes
curvas



1/2

13602

12,5 cm/5"

13602-14

14,0 cm/5 1/2"

13608 micro

12,5 cm/5"

gerade
straight
droits
rectas



1/2

13603

13603-14

13609 micro

gebogen
curved
courbes
curvas



1/2



13660-18

18,0 cm/7"

13660-20

21,0 cm/8 1/4"

gerade
straight
droits
rectas



13661-18

13661-20

gebogen
curved
courbes
curvas

Halsted-
Mosquito



13662-18

18,0 cm/7"

13662-20

21,0 cm/8 1/4"

gerade
straight
droits
rectas



13663-18

13663-20

gebogen
curved
courbes
curvas

Halsted-
Mosquito

1:2



SCHWERT
SWORD · ESPADA
EPEE · SPADA

Arterienklemmen Hemostatic Forceps Pincès hémostatiques Pinzas hemostáticas



Pean

- 13352-14** 14,0 cm/5½"
- 13352-16** 16,0 cm/6¼"

½



Pean

14,0 cm/5½"
fein, delicate, fine, fina

13392-14

gerade, straight
droits, rectas

13393-14

gebogen, curved
courbes, curvas

½



Rochester-Pean

gerade, straight
droits, rectas

- 13390-13** 13,0 cm/5"
- 13390-14** 14,0 cm/5½"
- 13390-16** 16,0 cm/6¼"
- 13390-18** 18,0 cm/7"
- 13390-20** 20,0 cm/8"
- 13390-22** 22,0 cm/8¾"
- 13390-24** 24,0 cm/9½"
- 13390-26** 26,0 cm/10¼"
- 13390-30** 30,0 cm/12"



Rochester-Pean

gebogen, curved
courbes, curvas

- 13391-13** 13,0 cm/5"
- 13391-14** 14,0 cm/5½"
- 13391-16** 16,0 cm/6¼"
- 13391-18** 18,0 cm/7"
- 13391-20** 20,0 cm/8"
- 13391-22** 22,0 cm/8¾"
- 13391-24** 24,0 cm/9½"
- 13391-26** 26,0 cm/10¼"
- 13391-30** 30,0 cm/12"

Arterienklemmen
Hemostatic Forceps
Pinces hémostatiques
Pinzas hemostáticas



SCHWERT
 SWORD · ESPADA
 EPEE · SPADA



Kocher
 14,0 cm/5½"
 fein, delicate, fine, fina

½



13432-14

gerade, straight
 droits, rectas



13433-14

gebogen, curved
 courbes, curvas



Ochsner-Kocher
 gerade, straight
 droits, rectas

- 13430-13** 13,0 cm/5"
- 13430-14** 14,0 cm/5½"
- 13430-16** 16,0 cm/6¼"
- 13430-18** 18,0 cm/7"
- 13430-20** 20,0 cm/8"
- 13430-22** 22,0 cm/8¾"
- 13430-24** 24,0 cm/9½"
- 13430-26** 26,0 cm/10¼"
- 13430-30** 30,0 cm/12"



Ochsner-Kocher
 gebogen, curved
 courbes, curvas

- 13431-13** 13,0 cm/5"
- 13431-14** 14,0 cm/5½"
- 13431-16** 16,0 cm/6¼"
- 13431-18** 18,0 cm/7"
- 13431-20** 20,0 cm/8"
- 13431-22** 22,0 cm/8¾"
- 13431-24** 24,0 cm/9½"
- 13431-26** 26,0 cm/10¼"
- 13431-30** 30,0 cm/12"



SCHWERT
SWORD · ESPADA
EPEE · SPADA

Arterienklemmen
Hemostatic Forceps
Pinces hémostatiques
Pinzas hemostáticas



13440-16 16,0 cm/6¼"
13440-20 20,0 cm/8"
gerade
straight
droits
rectas



13441-16
13441-20
gebogen
curved
courbes
curvas



Bainbridge
15,0 cm/6"



24590-15
gerade
straight
droits
rectas



24591-15
gebogen
curved
courbes
curvas



Bainbridge
18,5 cm/7¼"



24590
gerade
straight
droits
rectas



24591
gebogen
curved
courbes
curvas

Arterienklemmen
Hemostatic Forceps
Pincés hémostatiques
Pinzas hemostáticas



SCHWERT
SWORD · ESPADA
EPEE · SPADA



Kelly
14,5 cm/5½"



13580

gerade
straight
droits
rectas



13581

gebogen
curved
courbes
curvas

½



Kelly Rankin
16,0 cm/6¼"



13584

gerade
straight
droits
rectas



13585

gebogen
curved
courbes
curvas

½



13560

13561

13568

13569

1:2

Crile
14,5 cm/5½"

½



13564

gerade
straight
droits
rectas



13565

gebogen
curved
courbes
curvas

½

Crile-Rankin
16,0 cm/6¼"



SCHWERT
SWORD · ESPADA
EPEE · SPADA

**Arterienklemmen
Hemostatic Forceps
Pincès hémostatiques
Pinzas hemostáticas**



1/2

Providence Hospital
14,0 cm/5 1/2"



13618

gerade
straight
droits
rectas



13619

gebogen
curved
courbes
curvas



1/2

Lovelace

13688 15,5 cm/6"

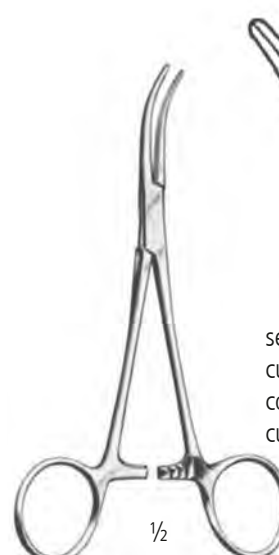

1/2

Dandy Crile

13511 14,0 cm/5 1/2"

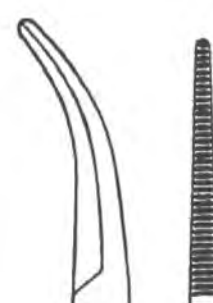

seitwärts gebogen
curved on side
courbe sur le côté
curva lateral

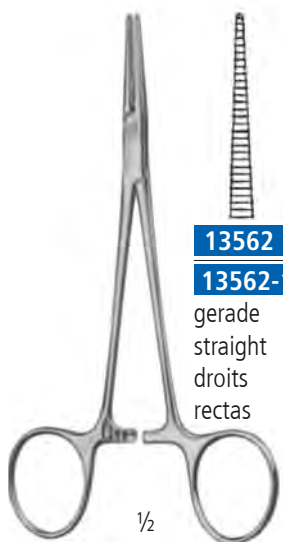

1/2

Baby-Crile



13562

14,0 cm/5 1/2"

13562-16

11,0 cm/4 1/2"

gerade
straight
droits
rectas



13563

gebogen
curved
courbes
curvas



1/2

Spencer-Wells



13520-13

13,0 cm/5"

13520-14

14,0 cm/5 1/2"

13520-15

15,5 cm/6"

13520-18

18,0 cm/7"

13520-20

20,0 cm/9"

13520-24

24,0 cm/9"

gerade
straight
droits
rectas



13521-13

13521-14

13521-15

13521-18

13521-20

13521-24

gebogen
curved
courbes
curvas

Arterienklemmen
 Hemostatic Forceps
 Pinces hémostatiques
 Pinzas hemostáticas



SCHWERT
 SWORD · ESPADA
 EPEE · SPADA



13590-15 gerade
 straight
 droits
 rectas

13591-15 gebogen
 curved
 courbes
 curvas

Leriché
 15,0 cm/6"

1/2



Pennington

13772 15,5 cm/6"
13772-20 20,0 cm/8"

1/2

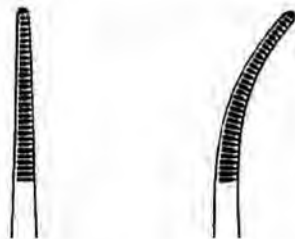

13670 gerade
 straight
 droits
 rectas

13671 gebogen
 curved
 courbes
 curvas

Adson
 18,5 cm/7 1/4"

1/2



13679-14 14,0 cm/5 1/2"
13679-18 18,0 cm/7"

Baby-Adson

1/2



SCHWERT
SWORD · ESPADA
EPEE · SPADA

**Arterienklemmen
Hemostatic Forceps
Pincès hémostatiques
Pinzas hemostáticas**

**Präparier- und Ligaturklemmen
Dissecting and Ligature Forceps
Pincès à dissequer et à ligatures
Pinzas para preparaciones y ligaduras**

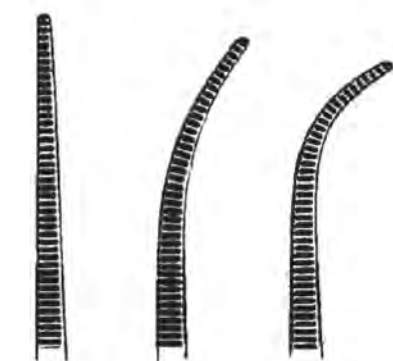
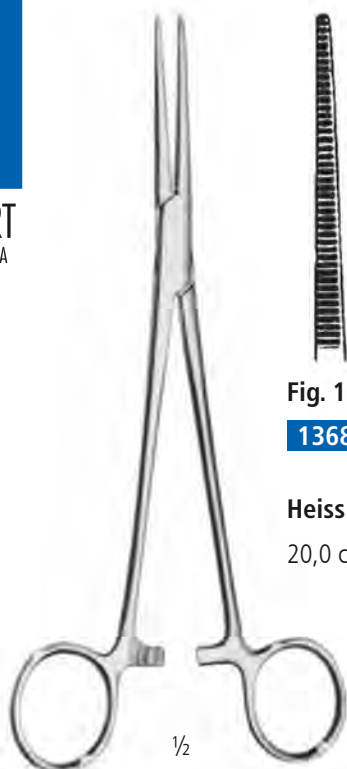

Fig. 1 13682
Fig. 2 13683
Fig. 3 13685

Arterienklemmen
Hemostatic Forceps
Pincès hémostatiques
Pinzas hemostáticas

Heiss
20,0 cm/8"

Präparier- und Ligaturklemmen, Dissecting and Ligature Forceps
Pincès à dissequer et à ligatures, Pinzas para preparaciones y ligaduras

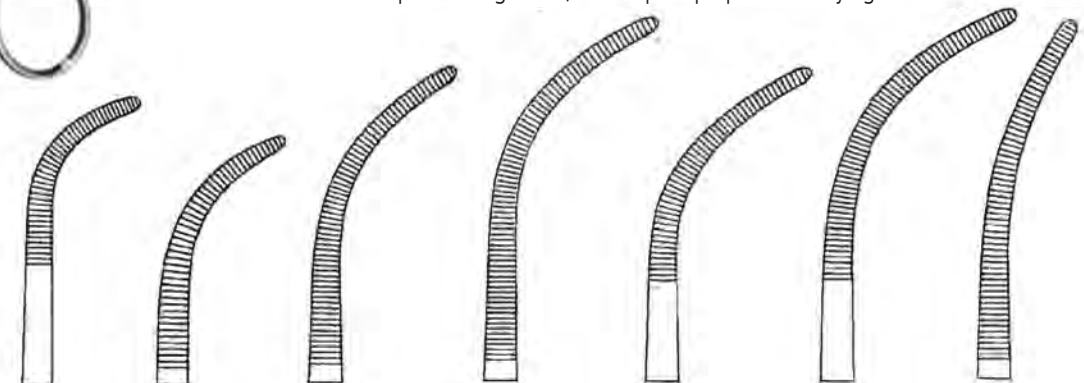

Fig. 1 13703-11 19,5 cm/7 1/4"
Fig. 2 13703-12 21,0 cm/8 1/4"
Fig. 3 13703-13 22,0 cm/8 3/4"
Fig. 4 13703-14 22,5 cm/9"
Fig. 5 13703-15 21,5 cm/8 1/2"
Fig. 6 13703-16 22,5 cm/9"
Fig. 7 13703-17 22,5 cm/9"

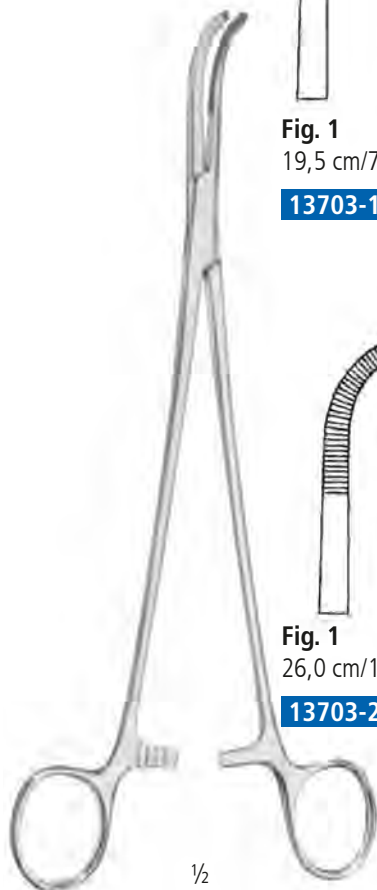

Fig. 1 13703-21 26,0 cm/10 1/4"
Fig. 2 13703-22 27,0 cm/10 1/2"
Fig. 3 13703-23 27,0 cm/10 3/4"
Fig. 4 13703-24 27,0 cm/10 3/4"
Fig. 5 13703-25 27,0 cm/10 3/4"
Fig. 6 13703-26 28,0 cm/11"
Fig. 7 13703-27 27,0 cm/10 3/4"

Overholt-Geissendoerfer

Arterienklemmen
Hemostatic Forceps
Pinces hémostatiques
Pinzas hemostáticas

Präparierklemmen
Dissecting Forceps
Pinces à disséquer
Pinzas para preparaciones



SCHWERT
 SWORD · ESPADA
 EPEE · SPADA

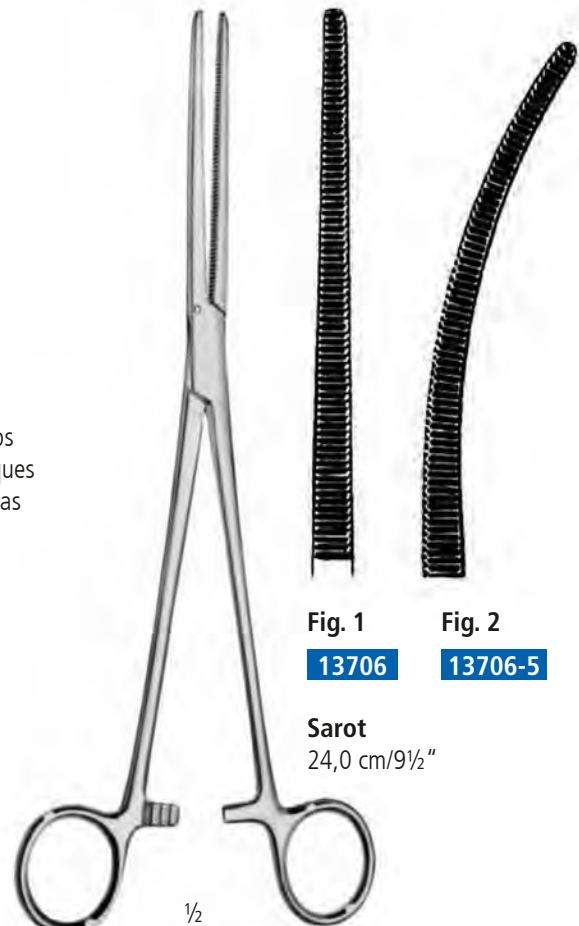
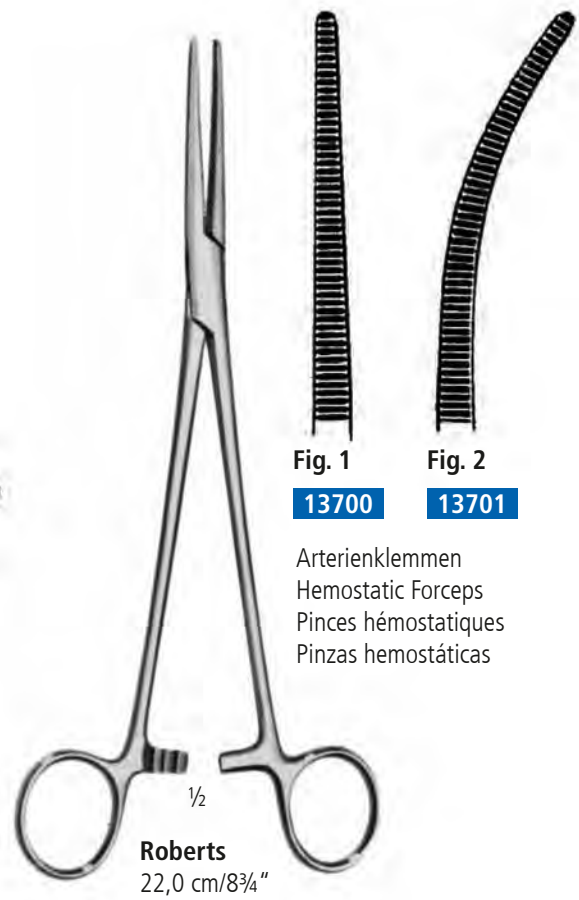
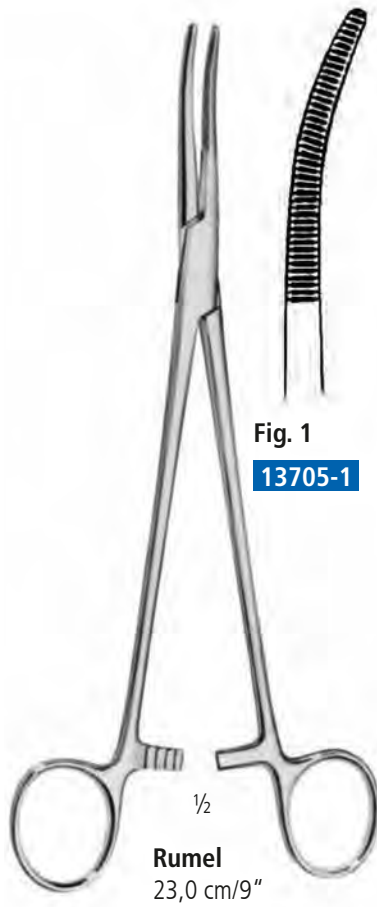



Arterienklemmen
Hemostatic Forceps
Pinces hémostatiques
Pinzas hemostáticas

SCHWERT
SWORD - ESPADA
EPEE - SPADA



Bengolea

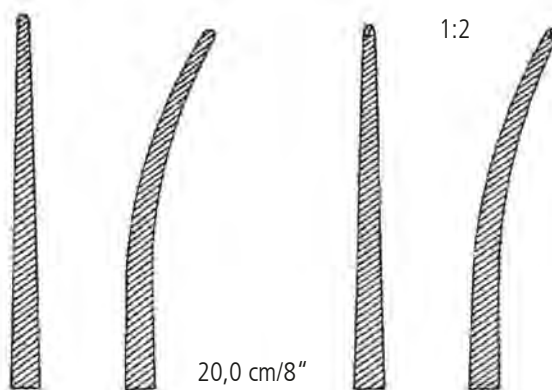

20,0 cm/8"

13714-20

13714-520

13715-20

13715-520

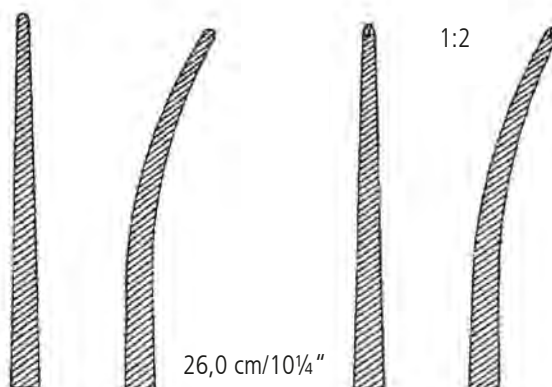

26,0 cm/10¼"

13714-26

13714-526

13715-26

13715-526

Präparier- und Ligaturklemmen
 Dissecting and Ligature Forceps
 Pincès à dissequer et à ligatures
 Pinzas para preparaciones y ligaduras



SCHWERT
 SWORD · ESPADA
 EPEE · SPADA

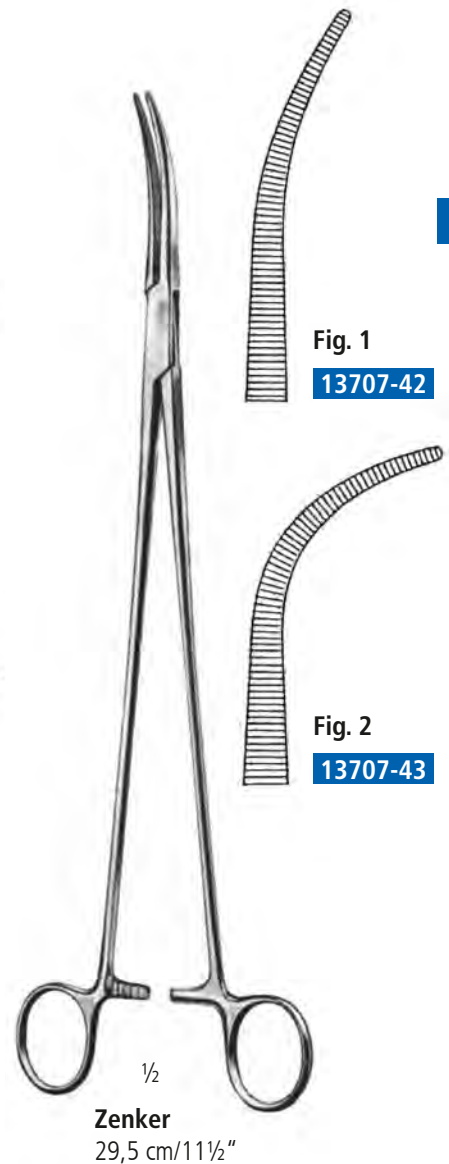
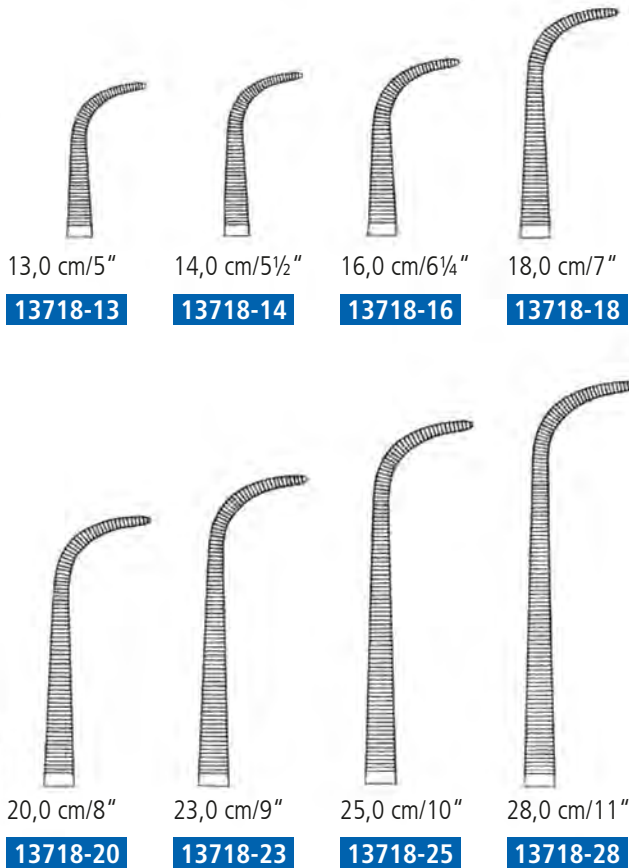
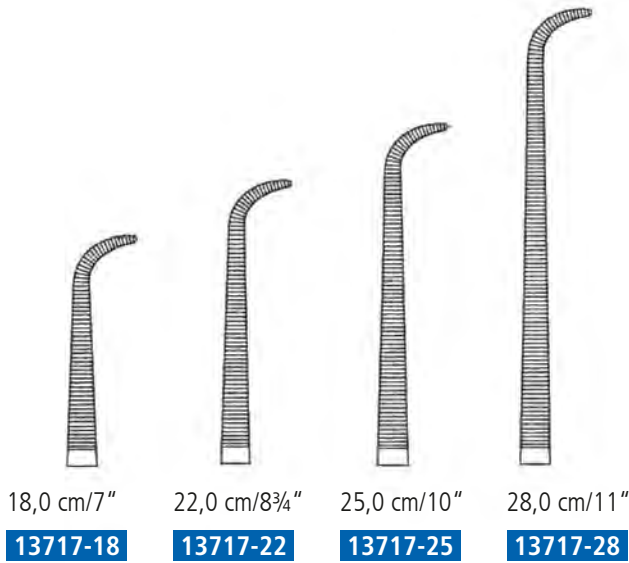



SCHWERT
SWORD - ESPADA
EPEE - SPADA

Arterienklemmen Hemostatic Forceps Pincés hémostatiques Pinzas hemostáticas



Mixer-Baby

13678-14 14,0 cm/5½"
13678-18 18,0 cm/7"



Mixer

13710-15 15,5 cm/6"
13710-19 19,0 cm/7½"
13711 22,0 cm/¾"



Mixer-O'Shaugnessy

13715-15 15,5 cm/6"
13715-19 19,0 cm/7½"



Fig. 1

13697-1

Fig. 2

13697-2

Negus

19,0 cm/7½"

Arterienklemmen
Hemostatic Forceps
Pincès hémostatiques
Pinzas hemostáticas

Gallenkanalklemmen
Gall Duct Clamps
Pincès pour voies biliaires
Pinzas para conductos biliares



SCHWERT
SWORD · ESPADA
EPEE · SPADA



13709-18

18,0 cm/7½"



13709-24

24,0 cm/9½"

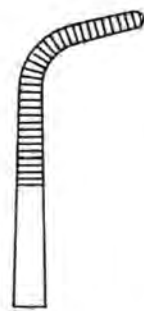

13709-27

28,0 cm/11"

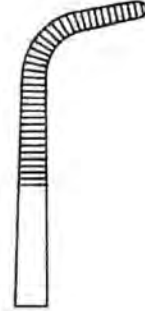

Kantrowitz

Gallenkanalklemmen
Gall Duct Clamps
Pincès pour voies biliaires
Pinzas para conductos biliares

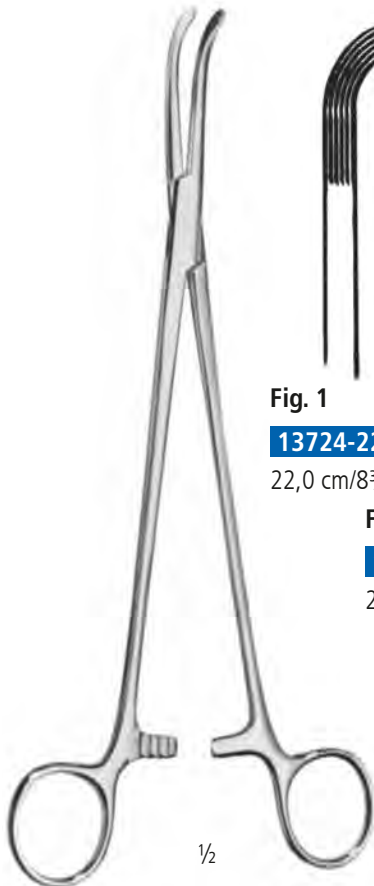

Fig. 1

13724-22

22,0 cm/8¾"



Fig. 2

13724-25

25,0 cm/10"



Fig. 3

13724-28

28,0 cm/18"

Mixer



13727-19

19,0 cm/7½"



13727-23

23,0 cm/9"



Lahey

Arterienklemmen
Hemostatic Forceps
Pinces hémostatiques
Pinzas hemostáticas

Nierenstiellklemmen, Gallenkanalklemmen
Kidney Pedicle Clamps, Gall Duct Clamps
Pinces hémostatiques Pincas pour pédicules rénaux, Pincas pour voies biliaires
Pinzas-clamps para pedúnculos renales y conductos biliares

Gallenkanalklemmen
 Gall Duct Clamps
 Pincas pour voies biliaires
 Pinzas para conductos biliares

Nierenstiellklemmen
 Kidney Pedicle Clamps
 Pincas hémostatiques Pincas pour pédicules rénaux
 Pinzas-clamps para pedúnculos renales



Lower
13729
 18,0 cm/7"



Mayo-Guyon
25007
 23,0 cm/9"

Gallenkanalklemmen
 Gall Duct Clamps
 Pincas pour voies biliaires
 Pinzas para conductos biliares

Arterienklemmen
 Hemostatic Forceps
 Pincas hémostatiques
 Pinzas hemostáticas

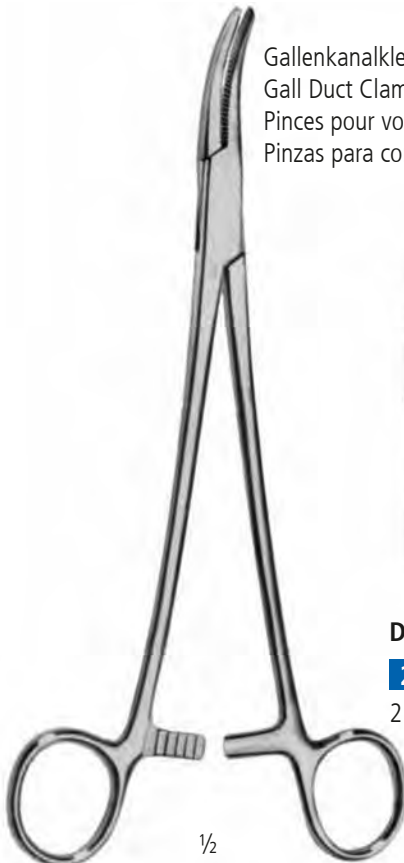

Desjardins
24905
 21,0 cm/8¼"

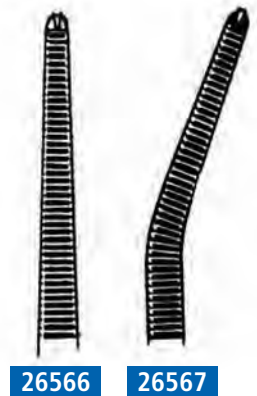

Phaneuf
 21,0 cm/8¼"

Klemmzangen
Clamp Forceps
Pinces-clamps
Pinzas-clamps

Hysterektomieklemmen
Hysterectomy Forceps
Pinces à hystérectomie
Pinzas para histerectomia



SCHWERT
 SWORD · ESPADA
 EPEE · SPADA

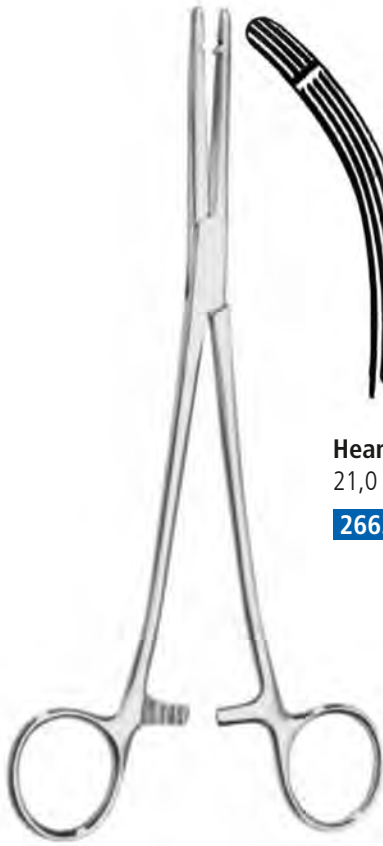

Heaney-Ballentine
 21,0 cm/8¼"

26634-5 **26634**



Heaney

26635-19 19,0 cm/7¾"
26635-21 21,0 cm/8¼"
 23,0 cm/9"

26637-19
26637-21
26637-23

Hysterektomieklemmen
 Hysterectomy Forceps
 Pinces à hystérectomie
 Pinzas para histerectomia

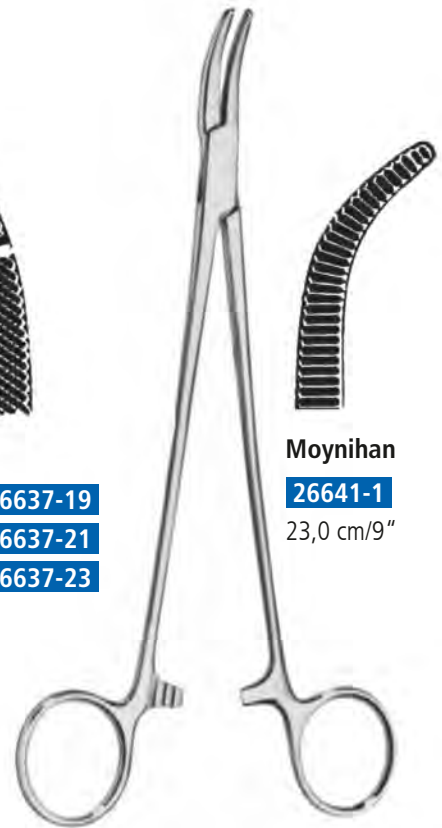

Moynihan

26641-1
 23,0 cm/9"

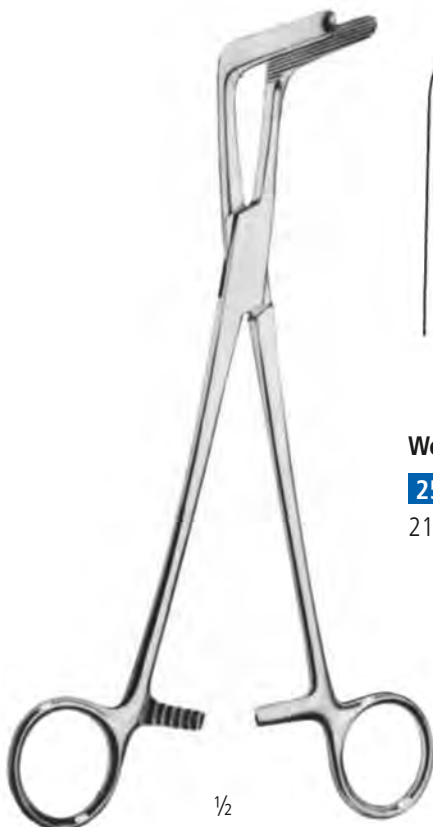

Wertheim-Cullen

25037-22
 21,5 cm/8½"



Wertheim

26632
 25,0 cm/10"





SCHWERT
SWORD · ESPADA
EPEE · SPADA

Klemmzangen
Clamp Forceps
Pincés-clamps
Pinzas-clamps

Peritoneumklemmen
Peritoneal Clamp Forceps
Pincés pour péritoine
Pinzas para peritoneo

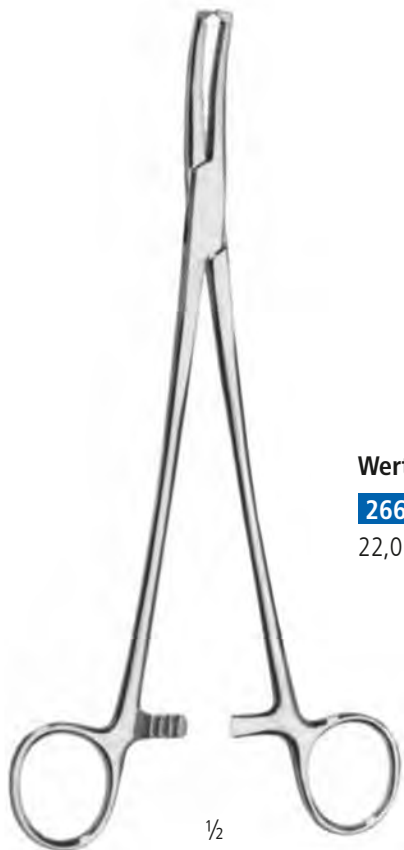

Klemmzangen
Clamp Forceps
Pincés-clamps
Pinzas-clamps

Wertheim

26632-22

22,0 cm/8³/₄"

1/2

Peritoneumklemmen, Peritoneal Clamp Forceps, Pincés pour péritoine, Pinzas para peritoneo



26675-1



26675-2

Mikulicz
20,0 cm/8"

1/2



26661-1



26661-2

Faure
20,0 cm/8"

1/2

Tuchklemmen
Towel Forceps
Pinces à champs
Pinzas de campo



SCHWERT
 SWORD · ESPADA
 EPEE · SPADA



Schädel
 9,0 cm/3½"

13943

gebogen
 curved
 courbes
 curvas

½



Jones

13941-5 5,5 cm/2¼"
13941 9,0 cm/3½"

½



Doyen

13985
 18,0 cm/7"

½



Peers

13964-14
 14,5 cm/5¾"

½



Backhaus

13957-9 9,0 cm/3½"
13957-11 11,0 cm/4½"
13957-13 13,0 cm/5"
13957-15 15,0 cm/6"

½

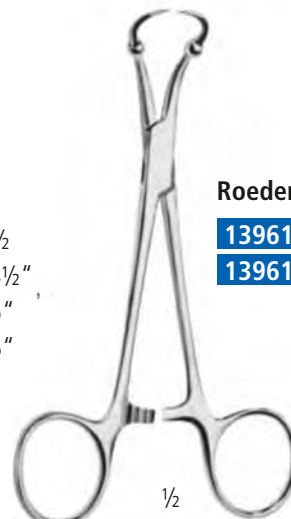

Roeder

13961-13 13,0 cm/5"
13961-15 15,0 cm/6"

½



Tuchklemmen
Towel Forceps
Pinces à champs
Pinzas de campo

SCHWERT
 SWORD · ESPADA
 EPEE · SPADA



Bernhard
13962
 16,0 cm/6¼"

½



Lane
13978-20
 20,0 cm/8"

½



Lorna
13965-10 10,0 cm/4"
13965-13 13,0 cm/5"

½

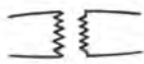

Ombredanne
13966-13
 13,5 cm/5½"

½

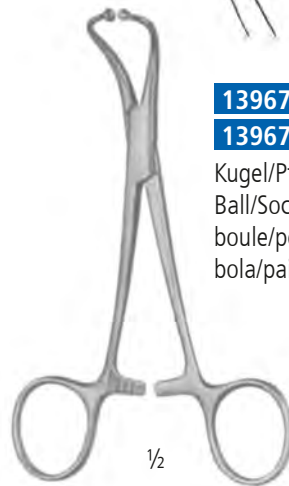

13967-11 11,0 cm/4½"
13967-13 13,0 cm/5"
 Kugel/Pfanne
 Ball/Socket
 boule/poêle
 bola/paila

½



13968-11 11,0 cm/4½"
13968-13 13,0 cm/5"
 Kugel/Kugel
 Ball/Ball
 boule/boule
 bola/bola

Tuchklemmen
Towel Forceps
Pinces à champs
Pinzas de campo

Schlauchklemmen
Tubing Clamps
Pinces presse-tube
Pinzas para tubos

Sterilisierklammern
Safety Pins
Porte-pinces
Porta-instrumentos

Tuchklemmen. Towel Forceps
 Pinces à champs, Pinzas de campo

Sterilisierklammern, Safety Pins
 Porte-pinces, Porta-instrumentos

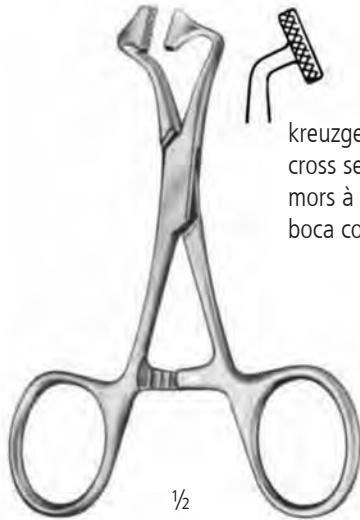

kreuzgerieft
 cross serrated
 mors à rainures croisées
 boca con estrias cruzadas

Thomas

13969-10 10,0 cm/4"
13969-13 13,0 cm/5"



Bunt

13996
 12,0 cm/4¾"



13998

13,0 cm/5"

Schlauchklemmen, Tubing Clamps, Pinces presse-tube, Pinzas para tubos

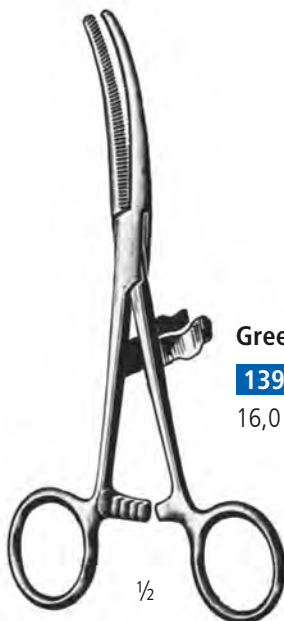

Green

13975-16
 16,0 cm/6¼"



Presbyterian
 16,0 cm/6½"

13978-16

glatt
 smooth
 mousse
 lisse





SCHWERT
SWORD · ESPADA
EPEE · SPADA

Schlauchklemmen
Tubing Clamps
Pinces presse-tube
Pinzas para tubos



1/2

13970-16

16,0 cm/6"

13970-18

18,0 cm/7"

13970-20

20,0 cm/8"

ohne U
without guard
sans protection
sin protecció



1/2

mit U
with guard
avec protection
con protecció

13971-16

16,0 cm/6"

13971-18

18,0 cm/7"

13971-20

20,0 cm/8"

Tupferzangen
Cotton Swab Forceps
Pinces à tampons
Pinzas para tampones

Korn-(Polypen-) zangen
Polypus and Dressing Forceps
Pinces à pansements et à polypes
Pinzas para pólipos y vendajes

Korn-(Polypen-) zangen, Polypus and Dressing Forceps
 Pinces à pansements et à polypes, Pinzas para pólipos y vendajes



SCHWERT
 SWORD · ESPADA
 EPEE · SPADA



21026-20
 gerade straight
 droits, rectas



Gross
 20,0 cm/8"
21027-20
 gebogen curved
 courbes curvas

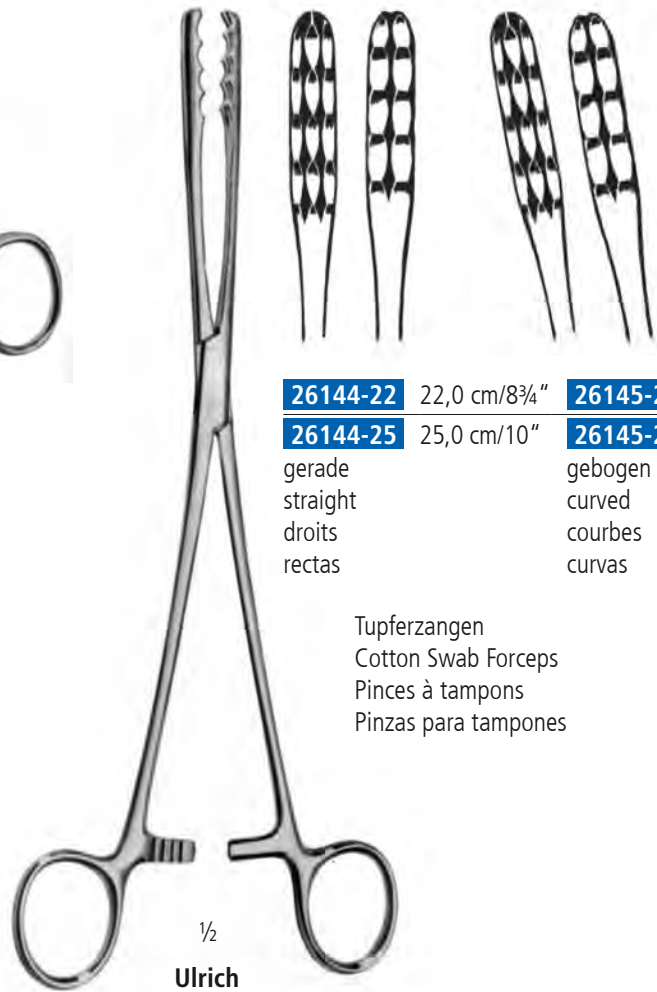

26144-22 22,0 cm/8¾" **26145-22**
26144-25 25,0 cm/10" **26145-25**
 gerade straight
 droits rectas
 gebogen curved
 courbes curvas

Tupferzangen
 Cotton Swab Forceps
 Pinces à tampons
 Pinzas para tampones



Lister
 Sinusklemmen
 Sinus Forceps
 Pinces à sinus
 Pinzas para seno
26140-13 13,0 cm/5"
26140-16 16,0 cm/6¼"
26140-18 18,0 cm/7"



SCHWERT
SWORD · ESPADA
EPEE · SPADA

Korn-(Polypen-) zangen
Polypus and Dressing Forceps
Pinces à pansements et à polypes
Pinzas para póipos y vendajes

Tupferzangen
Cotton Swab Forceps
Pinces à tampons
Pinzas para tampones

Korn-(Polypen-) zangen, Polypus and Dressing Forceps, Pinces à pansements et à polypes, Pinzas para póipos y vendajes

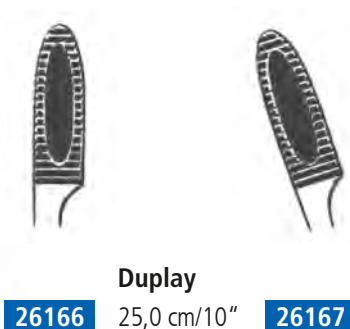
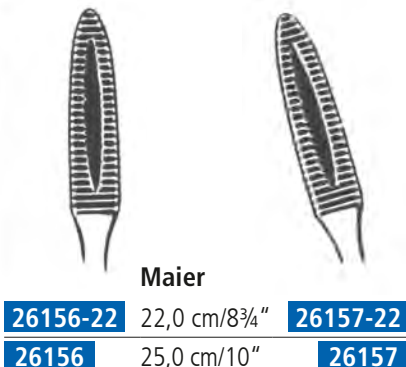

Tupferzange
Cotton Swab Forceps
Pinces à tampon
Pinzas para tampone



Bozemann

26257
26,0 cm/10 ¹ / ₄ "

Tupferzangen
Cotton Swab Forceps
Pinces à tampons
Pinzas para tampones

Schwammzangen
Sponge Holding Forceps
Pinces à éponges
Pinzas porta-esponjas



SCHWERT
 SWORD · ESPADA
 EPEE · SPADA



Tupferzangen
 Cotton Swab Forceps
 Pinces à tampons
 Pinzas para tampones

Collin
 25,0 cm/10"

26194

Cheron
 25,0 cm/10"

26190



1/2



Foerster

26232-18	26233-18	18,0 cm/7"	26234-18	26235-18
26232-20	26233-20	20,0 cm/8"	26234-20	26235-20
26232	26233	25,0 cm/10"	26234	26235

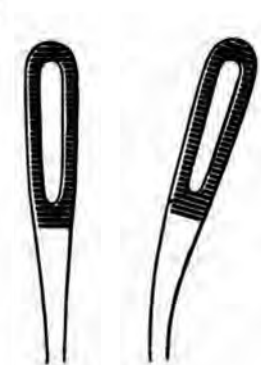

26240-25

26241-25

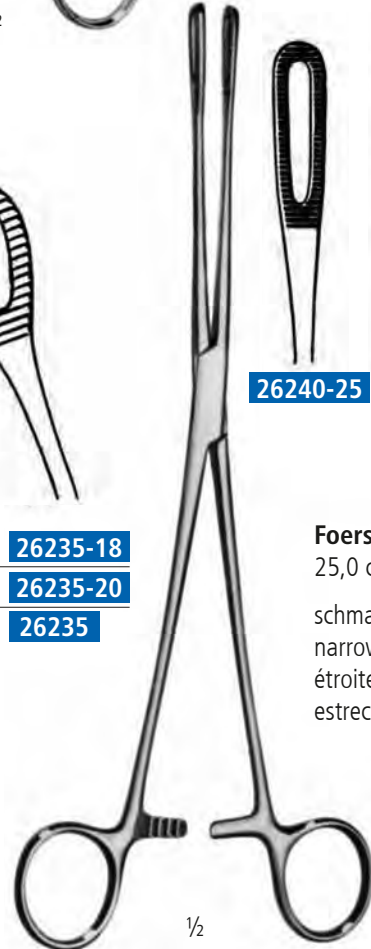

1/2

Foerster
 25,0 cm/10"
 schmal
 narrow
 étroite
 estrecha



SCHWERT
SWORD · ESPADA
EPEE · SPADA

Schwammzangen
Sponge Holding Forceps
Pinces à éponges
Pinzas porta-esponjas

Sterilisierzangen
Sterilizing Forceps
Pinces à stérilisation
Pinzas para esterilización

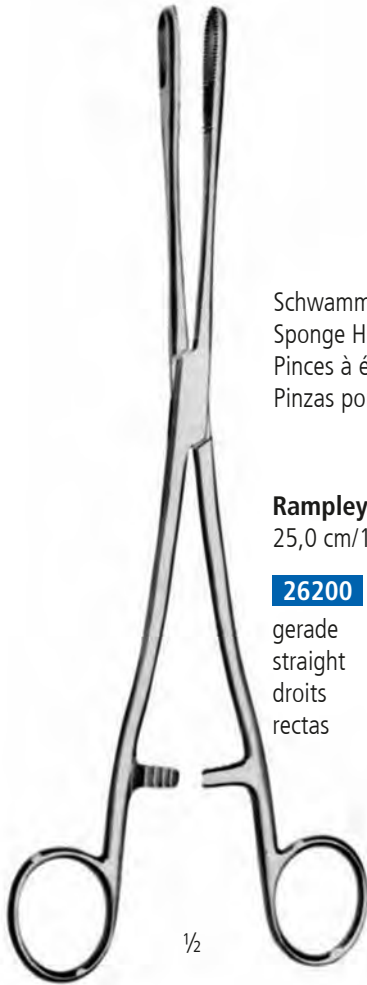

1/2

Schwammzangen
Sponge Holding Forceps
Pinces à éponges
Pinzas porta-esponjas

Rampley
25,0 cm/10"

26200
gerade
straight
droits
rectas

26201
gebogen
curved
courbes
curvas



1/2

Davis
Sterilisierpinzette
Sterilizing Forceps
Pinces à stérilisation
Pinzas para esterilización

28351-16 16,0 cm/6¼"

28351-20 20,0 cm/8"

28351-24 24,0 cm/9½"

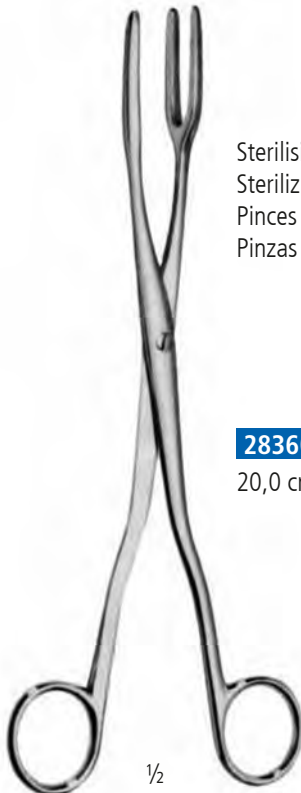

1/2

Sterilisierzangen
Sterilizing Forceps
Pinces à stérilisation
Pinzas para esterilización

28360-20
20,0 cm/8"



SCHWERT
SWORD · ESPADA
EPEE · SPADA

Knochenchirurgie-Instrumente

Bone Surgery Instruments

Instrumentation pour la Chirurgie Osseuse

Instrumental para la cirugía ósea





SCHWERT
SWORD · ESPADA
EPEE · SPADA

Amputations- und Resektionssägen Amputating and Resection Saws Scies à amputation et à resection Sierras para amputación y resección



Charrière

13238-35

35,0 cm/14"

Ersatzsägeblatt
Spare saw blade
Lame scie de rechange
Hoja de sierra de repuesto

13238-12 12 mm

13238-15 15 mm

13238-18 18 mm



Satterlee

13222

29,0 cm/11½"

Ersatzsägeblatt
Spare saw blade
Lame scie de rechange
Hoja de sierra de repuesto

13222-1



Langenbeck

13214

23,0 cm/9"



Charrière

13218-27 27,0 cm/10½"

13218-30 30,0 cm/12"

Ersatzsägeblatt
Spare saw blade
Lame scie de rechange
Hoja de sierra de repuesto

13218-115 15 mm

13218-120 20 mm

Amputationsretractor
Amputating Retractor
Retracteur à amputation
Retractor para amputación

Amputations- und Resektionssägen
Amputating and Resection Saws
Scies à amputation et à resection
Sierras para amputación y resección



SCHWERT
 SWORD · ESPADA
 EPEE · SPADA

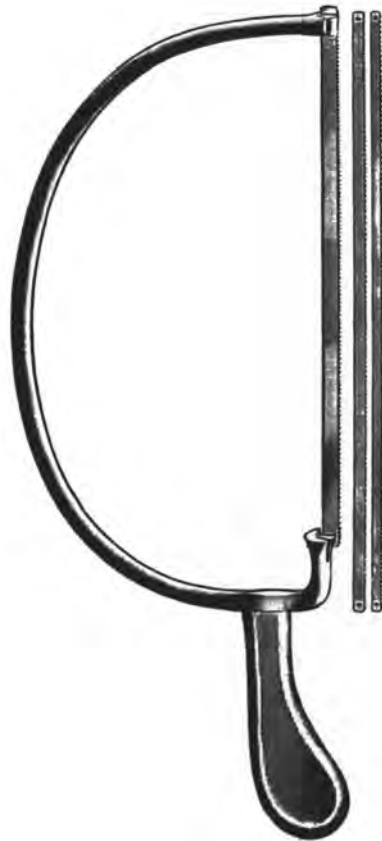

Helferich-Bier

13242

39,0 cm/15½"

Ersatzsägeblatt
 Spare saw blade
 Lame scie de rechange
 Hoja de sierra de repuesto

13242-5 5 mm

13242-6 6 mm

13242-8 8 mm

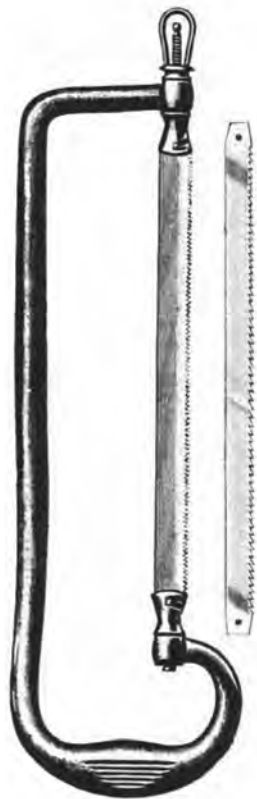

Rust

13232

24,0 cm/9½"

komplett mit je 1 Sägeblatt
 12 und 18 mm
 complete with saw blade
 12 and 18 mm
 complet avec lame de scie
 12 et 18 mm
 completo con hoja de sierra
 12 y 18 mm

Ersatzsägeblatt
 Spare saw blade
 Lame scie de rechange
 Hoja de sierra de repuesto

13232-6 6 mm

13232-8 8 mm

13232-15 15 mm

13232-18 18 mm

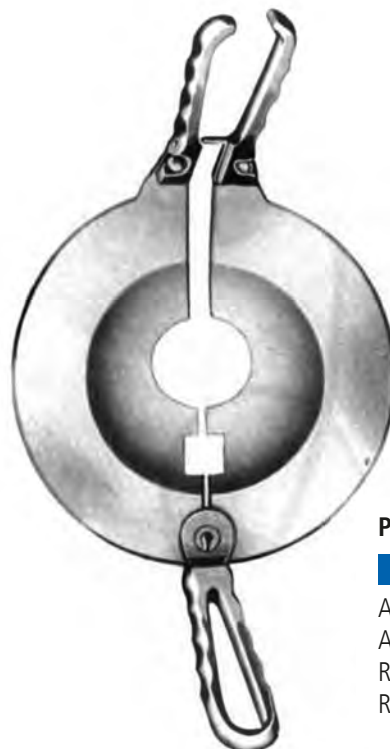

Percy

13197

Amputations-Retraktor
 Amputating retractor
 Retracteur à amputation
 Retractor para amputación



Bohrinstrumente
Bone Drills
Instruments à perferer
Instrumental para perforar

SCHWERT
SWORD · ESPADA
EPEE · SPADA



Bohrer-, Führungs- und Gefäß-Schutzzange
Drill guide and vascular protecting forceps
Pince de protection des forets, des guides et des vaisseaux
Alicates de perforación, guía y protección de recipientes

Adson

14178

15,0 cm/6"

Schraubendreher
Srew Drivers
Tourne-vis
Destornilladores



SCHWERT
SWORD · ESPADA
EPEE · SPADA



14325-25 2,5 mm
14325-35 3,5 mm



Lane
14331
25,0 cm/10"



14332
25,0 cm/10"



SCHWERT
SWORD - ESPADA
EPEE - SPADA

**Flachzangen
Flat Nose Pliers
Pinces plates
Alicates planos**



17,0 cm/6¾"



Fig. 1

14123-1

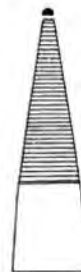

Fig. 2

14123-2



14124
19,0 cm/7½"



14125
14,0 cm/5½"

spitz
sharp
pointu
agudo



14130
14,0 cm/5½"

stumpf
blunt
mousse
romo

Drahtzangen
Wire Cutting Pliers
Pinces à fils
Alicates para cortar alambre



SCHWERT
 SWORD · ESPADA
 EPEE · SPADA



18,0 cm/7"

Fig. 1
14126-2



Fig. 2
14126-5



Fig. 3
14126-7



Fig. 4
14128



Flachzangen
 Flat Nose Pliers
 Pinces plates
 Alicates planos

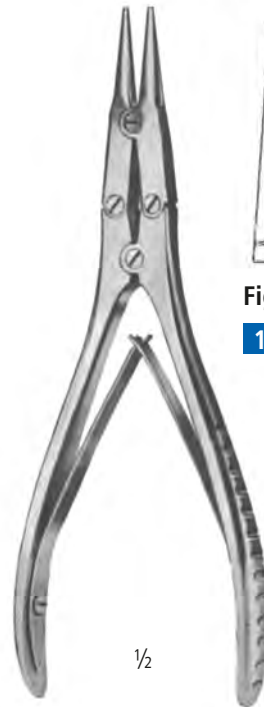

18,0 cm/7"



14152
 16,0 cm/6¼"

Kopfschneider
 Wire cutting pliers
 Pinces à couper le fil
 Alicates para cortar alambre



14160-15
 15,0 cm/6"

Kopfschneider
 Wire cutting pliers
 Pinces à couper le fil
 Alicates para cortar alambre

für harten Draht bis 1,5 mm
 for hard wire up to 1,5 mm
 pour fils durs jusqu'à 1,5 mm
 para hilos duros hasta 1,5 mm



SCHWERT
SWORD · ESPADA
EPEE · SPADA

Drahtzangen Wire Cutting Pliers Pincès à fils Alicates para cortar alambre



Seitenschneider
Lateral wire cutter
Pince à couper le fil à tranchant latéral
Alicates para cortar alambre con corte lateral

14161-23

23,0 cm/9"

für harten Draht bis 2,2 mm
for hard wire up to 2,2 mm
pour fils durs jusqu'à 2,2 mm
para hilos duros hasta 2,2 mm



Kopfschneider
Frontal wire cutting pliers
Pince à couper le fil à tranchant frontal
Alicates para cortar alambre con corte frontal

14162-21

21,0 cm/8¼"

für harten Draht bis 2,5 mm
for hard wire up to 2,5 mm
pour fils durs jusqu'à 2,5 mm
para hilos duros hasta 2,5 mm



Bolzenschneider
Wire cutting pliers
Pince à couper le fil
Alicates para cortar alambre

14164-45

45,0 cm/18"

14164-56

56,0 cm/22½"

für Draht bis	6 mm	7,5 mm
for wire up to	6 mm	7,5 mm
pour fils jusqu'à	6 mm	7,5 mm
para hilos hasta	6 mm	7,5 mm

14164-1

Ersatzbacken Satz
Set of cutting parts
Jeu de coupantes seules
Juego de mandíbulas de repuesto

Meissel und Osteotome Bone Chisels and Gouges Ciseaux-burins, Gouges Cinceles, Gubias



SCHWERT
SWORD · ESPADA
EPEE · SPADA

Osteotome
Osteotomes
Osteotomos



13,5 cm/5¼"

- 14640-A3** 3 mm
- 14640-A4** 4 mm
- 14640-A5** 5 mm
- 14640-A6** 6 mm
- 14640-A8** 8 mm
- 14640-A10** 10 mm
- 14640-A12** 12 mm
- 14640-A14** 14 mm
- 14640-A16** 16 mm

Flachmeissel
Bone chisels
Ciseaux-burins
Cinceles



13,5 cm/5¼"

- 14640-B4** 4 mm
- 14640-B6** 6 mm
- 14640-B8** 8 mm
- 14640-B10** 10 mm
- 14640-B12** 12 mm
- 14640-B14** 14 mm
- 14640-B16** 16 mm

Hohlmeissel
Gouges
Gouges
Gubias



13,5 cm/5¼"

- 14641-3** 3 mm
- 14641-4** 4 mm
- 14641-5** 5 mm
- 14641-6** 6 mm
- 14641-8** 8 mm
- 14641-10** 10 mm
- 14641-12** 12 mm
- 14641-14** 14 mm
- 14641-16** 16 mm

Flachmeissel
Bone chisels
Ciseaux-burins
Cinceles

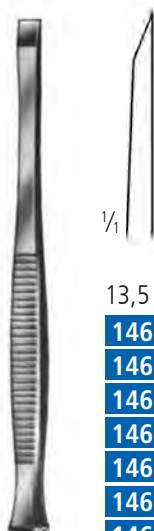

13,5 cm/5¼"

- 14652-2** 2 mm
- 14652-3** 3 mm
- 14652-4** 4 mm
- 14652-5** 5 mm
- 14652-6** 6 mm
- 14652-7** 7 mm
- 14652-8** 8 mm

Partsch

Hohlmeissel
Gouges
Gouges
Gubias



17,0 cm/6¾"

- 14654-2** 2 mm
- 14654-3** 3 mm
- 14654-4** 4 mm
- 14654-5** 5 mm
- 14654-6** 6 mm
- 14654-7** 7 mm
- 14654-8** 8 mm

Partsch

13,5 cm/5¼"

- 14653-2** 2 mm
- 14653-3** 3 mm
- 14653-4** 4 mm
- 14653-5** 5 mm
- 14653-6** 6 mm
- 14653-7** 7 mm
- 14653-8** 8 mm



17,0 cm/6¾"

- 14655-2** 2 mm
- 14655-3** 3 mm
- 14655-4** 4 mm
- 14655-5** 5 mm
- 14655-6** 6 mm
- 14655-7** 7 mm
- 14655-8** 8 mm



SCHWERT
SWORD · ESPADA
EPEE · SPADA

Meissel und Osteotome Bone Chisels and Gouges Ciseaux-burins, Gouges Cinceles, Gubias



Flachmeissel
Bone chisels
Ciseaux-burins
Cinceles

1/2

Alexander

18,0 cm/7"

14668-4	4 mm
14668-6	6 mm
14668-8	8 mm
14668-10	10 mm
14668-12	12 mm
14668-14	14 mm



Hohlmeissel
Gouges
Gouges
Gubias

1/2

Alexander

18,0 cm/7"

14669-4	4 mm
14669-6	6 mm
14669-8	8 mm
14669-10	10 mm
14669-12	12 mm
14669-14	14 mm



1/2

Mini-Lambotte



1/1

12,5 cm/5"

14684-3	3 mm
14684-4	4 mm
14684-6	6 mm
14684-8	8 mm
14684-10	10 mm
14684-12	12 mm
14684-15	15 mm

Osteotome
Osteotomes
Osteotomes
Osteotomos



1/1

17,0 cm/6 3/4"

14685-3	3 mm
14685-4	4 mm
14685-6	6 mm
14685-8	8 mm
14685-10	10 mm
14685-12	12 mm
14685-15	15 mm

Osteotome
Osteotomes
Osteotomes
Osteotomos

Meissel und Osteotome
Bone Chisels and Gouges
Ciseaux-burins, Gouges
Cinceles, Gubias



SCHWERT
 SWORD · ESPADA
 EPEE · SPADA



Osteotome, gerade
 Osteotomes, straight
 Osteotomes, droits
 Osteotomos, rectos

24,0 cm/9½"

- 14688-8** 8 mm
- 14688-10** 10 mm
- 14688-13** 13 mm
- 14688-15** 15 mm
- 14688-20** 19 mm
- 14688-25** 25 mm
- 14688-30** 32 mm
- 14688-38** 38 mm

½

Lambotte



Osteotome, gebogen
 Osteotomes, curved
 Osteotomes, courbes
 Osteotomos, curvos

23,0 cm/9"

- 14689-8** 8 mm
- 14689-10** 10 mm
- 14689-13** 13 mm
- 14689-15** 15 mm
- 14689-20** 19 mm
- 14689-25** 25 mm
- 14689-30** 32 mm
- 14689-38** 38 mm

½

Lambotte



Flachmeissel
 Bone chisels
 Ciseaux-burins
 Cinceles

16,0 cm/6¼"

- 14658-4** 4 mm
- 14658-6** 6 mm

½

Lucas



Hohlmeissel
 Gouges
 Gouges
 Gubias

16,0 cm/6¼"

- 14659-3** 3 mm
- 14659-5** 5 mm

½

Lucas



SCHWERT
SWORD · ESPADA
EPEE · SPADA

Meissel und Osteotome Bone Chisels and Gouges Ciseaux-burins, Gouges Cinceles, Gubias



Osteotome, gerade
Osteotomes, straight
Osteotomes, droits
Osteotomos, rectos

16,0 cm/6 1/4"

14666-4	4 mm
14666-6	6 mm
14666-8	8 mm
14666-10	10 mm
14666-12	12 mm
14666-15	15 mm

Stille



Hohlmeissel
Gouges
Gouges
Gubias

16,0 cm/6 1/4"

14667-6	6 mm
14667-8	8 mm
14667-10	10 mm
14667-12	12 mm
14667-15	15 mm

Stille



Osteotome, gebogen
Osteotomes, curved
Osteotomes, courbes
Osteotomos, curvos

20,0 cm/8"

14663-10	10 mm
14663-15	15 mm
14663-20	20 mm
14663-25	25 mm

Stille



Flachmeissel
Bone chisels
Ciseaux-burins
Cinceles

20,0 cm/8"

14662-6	6 mm
14662-8	8 mm
14662-10	10 mm
14662-12	12 mm
14662-15	15 mm
14662-20	20 mm
14662-25	25 mm
14662-30	30 mm

Stille

Meissel und Osteotome
Bone Chisels and Gouges
Ciseaux-burins, Gouges
Cinceles, Gubias



SCHWERT
SWORD · ESPADA
EPEE · SPADA



Osteotome, gerade
Osteotomes, straight
Osteotomes, droits
Osteotomos, rectos

20,0 cm/8"

14660-6	6 mm
14660-8	8 mm
14660-10	10 mm
14660-12	12 mm
14660-15	15 mm
14660-20	20 mm
14660-25	25 mm
14660-30	30 mm

Stille



Hohlmeissel
Gouges
Gouges
Gubias

20,0 cm/8"

14665-6	6 mm
14665-8	8 mm
14665-10	10 mm
14665-12	12 mm
14665-15	15 mm
14665-20	20 mm
14665-25	25 mm
14665-30	30 mm

Stille



Osteotome, gerade
Osteotomes, straight
Osteotomes, droits
Osteotomos, rectos

20,0 cm/8"

14704-6	6 mm
14704-9	9 mm
14704-13	13 mm
14704-16	16 mm
14704-19	19 mm
14704-25	25 mm
14704-32	32 mm

Smith-Petersen



Osteotome, gebogen
Osteotomes, curved
Osteotomes, courbes
Osteotomos, curvos

20,0 cm/8"

14705-6	6 mm
14705-9	9 mm
14705-13	13 mm
14705-16	16 mm
14705-19	19 mm
14705-25	25 mm
14705-32	32 mm

Smith-Petersen



SCHWERT
SWORD · ESPADA
EPEE · SPADA

Meissel und Osteotome
Bone Chisels and Gouges
Ciseaux-burins, Gouges
Cinceles, Gubias



Hohlmeissel, gerade
Gouges, straight
Gouges, droits
Gubias, rectos

20,0 cm/8"

- 14706-6** 6 mm
- 14706-9** 9 mm
- 14706-13** 13 mm
- 14706-16** 16 mm
- 14706-19** 19 mm
- 14706-25** 25 mm
- 14706-32** 32 mm

Smith-Petersen



Hohlmeissel, gebogen
Gouges, curved
Gouges, courbes
Gubias, curvos

20,0 cm/8"

- 14707-6** 6 mm
- 14707-9** 9 mm
- 14707-13** 13 mm
- 14707-16** 16 mm
- 14707-19** 19 mm
- 14707-25** 25 mm
- 14707-32** 32 mm

Smith-Petersen

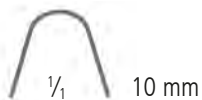

Hohlmeissel, gerade
Gouges, straight
Gouges, droits
Gubias, rectos

25,0 cm/10"

- 14702-10** 10 mm

Lexer

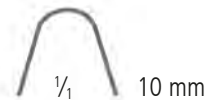

Hohlmeissel, gebogen
Gouges, curved
Gouges, courbes
Gubias, curvos

25,0 cm/10"

- 14703-10** 10 mm

Lexer

Meissel und Osteotome
Bone Chisels and Gouges
Ciseaux-burins, Gouges
Cinceles, Gubias



SCHWERT
 SWORD · ESPADA
 EPEE · SPADA

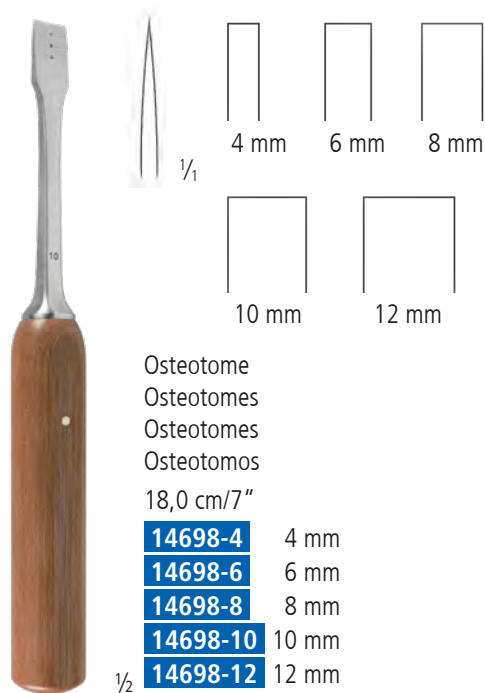

Osteotome
 Osteotomes
 Osteotomes
 Osteotomos

18,0 cm/7"

- 14698-4** 4 mm
- 14698-6** 6 mm
- 14698-8** 8 mm
- 14698-10** 10 mm
- 14698-12** 12 mm

Mini-Lexer

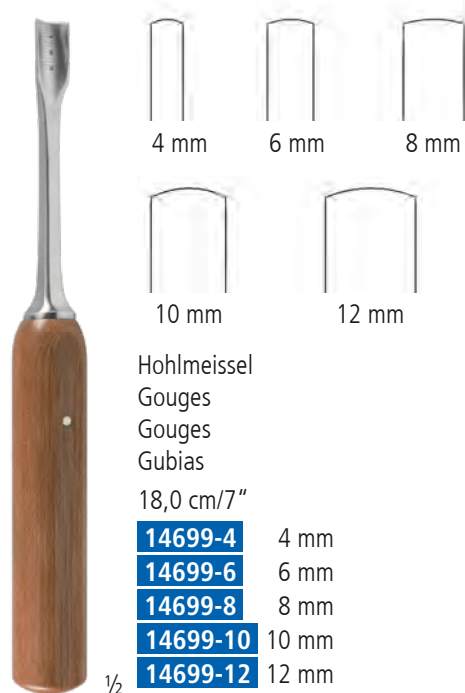

Hohlmeissel
 Gouges
 Gouges
 Gubias

18,0 cm/7"

- 14699-4** 4 mm
- 14699-6** 6 mm
- 14699-8** 8 mm
- 14699-10** 10 mm
- 14699-12** 12 mm

Mini-Lexer



Osteotome
 Osteotomes
 Osteotomes
 Osteotomos

22,0 cm^{3/4}"

- 14700-5** 5 mm
- 14700-7** 7 mm
- 14700-10** 10 mm
- 14700-15** 15 mm
- 14700-20** 20 mm
- 14700-25** 25 mm
- 14700-30** 30 mm

Lexer

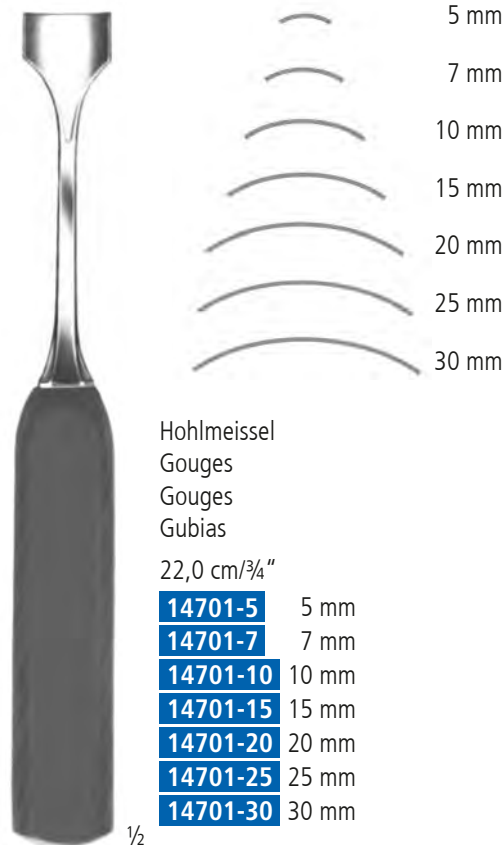

Hohlmeissel
 Gouges
 Gouges
 Gubias

22,0 cm^{3/4}"

- 14701-5** 5 mm
- 14701-7** 7 mm
- 14701-10** 10 mm
- 14701-15** 15 mm
- 14701-20** 20 mm
- 14701-25** 25 mm
- 14701-30** 30 mm

Lexer



SCHWERT
SWORD · ESPADA
EPEE · SPADA

Meissel und Osteotome Bone Chisels and Gouges Ciseaux-burins, Gouges Cinceles, Gubias

Osteotome, gerade
Osteotomes, straight
Osteotomes, droits
Osteotomos, rectos



14,0 cm/4 3/4"

- 14710-3** 3 mm
- 14710-5** 5 mm
- 14710-6** 6 mm
- 14710-8** 8 mm
- 14710-9** 9 mm

Hoke

Osteotome, gerade
Osteotomes, straight
Osteotomes, droits
Osteotomos, rectos



24,0 cm/9 1/2"

- 14676-6** 6 mm
- 14676-13** 13 mm
- 14676-19** 19 mm
- 14676-25** 25 mm
- 14676-32** 32 mm

Hibbs

Flachmeissel, gerade
Bone chisels, straight
Ciseaux-burins, droits
Cinceles, rectos



24,0 cm/9 1/2"

- 14677-6** 6 mm
- 14677-13** 13 mm
- 14677-19** 19 mm
- 14677-25** 25 mm
- 14677-32** 32 mm

Hibbs

Meissel und Osteotome
Bone Chisels and Gouges
Ciseaux-burins, Gouges
Cinceles, Gubias



SCHWERT
 SWORD · ESPADA
 EPEE · SPADA

Osteotome
 Osteotomes
 Osteotomos



24,0 cm/9½"

14678-6	6 mm
14678-13	13 mm
14678-19	19 mm
14678-25	25 mm
14678-32	32 mm

Hibbs

Hohlmeissel
 Gouges
 Gouges
 Gubias



24,0 cm/9½"

14679-6	6 mm
14679-13	13 mm
14679-19	19 mm
14679-25	25 mm
14679-32	32 mm

Hibbs

Hohlmeissel
 Gouges
 Gouges
 Gubias



24,0 cm/9½"

14680-6	6 mm
14680-13	13 mm
14680-19	19 mm
14680-25	25 mm
14680-32	32 mm

Hibbs





SCHWERT
SWORD · ESPADA
EPEE · SPADA

Scharfe Löffel
Bone Curettes
Curettes tranchantes
Cucharillas cortantes



Volkmann
17,0 cm/6¾"

	Fig.	mm
14795-40	0000	3,0
14795-30	000	4,0
14795-20	00	5,0
14795-10	0	6,0
14795-1	1	7,0
14795-2	2	8,0
14795-3	3	10,0
14795-4	4	11,6
14795-5	5	12,6
14795-6	6	13,6

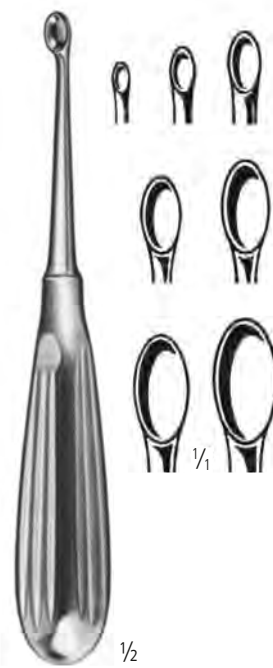

Schede
17,0 cm/6¾"

	Fig.	mm
14796-30	000	3,0
14796-20	00	4,0
14796-10	0	5,0
14796-1	1	6,0
14796-2	2	6,5
14796-3	3	7,7
14796-4	4	8,5

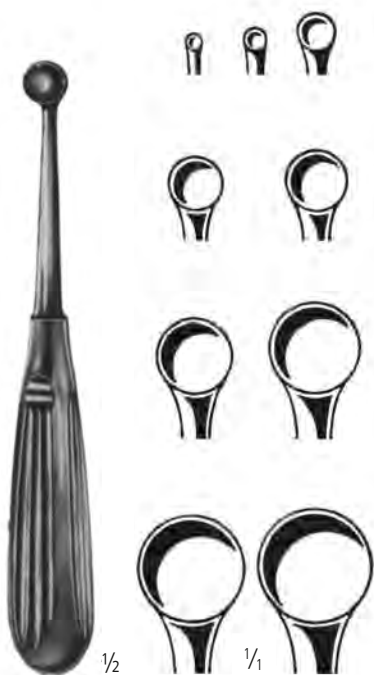

Bruns
17,0 cm/6¾"

	Fig.	mm
14794-30	000	3,0
14794-20	00	4,0
14794-10	0	5,0
14794-1	1	6,0
14794-2	2	8,0
14794-3	3	10,0
14794-4	4	12,0
14794-5	5	13,0
14794-6	6	14,0

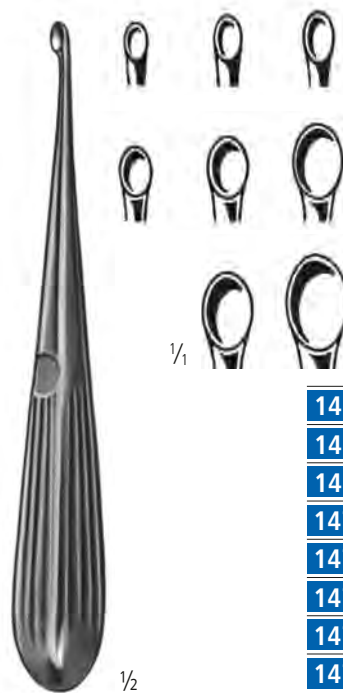

Spratt
17,0 cm/6¾"

	Fig.	mm
14793-30	000	3,0
14793-20	00	4,0
14793-10	0	4,5
14793-1	1	5,0
14793-2	2	6,0
14793-3	3	7,0
14793-4	4	8,5
14793-5	5	9,5

Scharfe Löffel
Bone Curettes
Curettes tranchantes
Cucharillas cortantes



SCHWERT
SWORD · ESPADA
EPEE · SPADA



	Fig.	mm
14786-20	00	2,0
14786-10	0	2,5
14786-1	1	3,5
14786-2	2	5,0

Williger
17,0 cm/6¾"



	Fig.	mm
14791-30	000	2,0
14791-20	00	2,5
14791-10	0	3,3
14791-1	1	3,8
14791-2	2	4,8
14791-3	3	5,5
14791-4	4	6,0
14791-5	5	6,7
14791-6	6	7,3

Bruns
23,0 cm/9"



Volkmann
14778-13
—
14778-17

Volkmann
14780-13
—
14780-20

Länge Length Longueur Largo	oval/oval oval/oval ovale/ovale ovalada/ovalada	oval/rund oval/round ovale/ronde ovalada/redonda
13,0 cm/5"	14778-13 7,5/6,3 mm	14780-13 6,3/6,8 mm
14,5 cm/5¾"	14778-14 6,8/5,8 mm	
16,0 cm/6¼"		14780-16 7,0/9,0 mm
17,0 cm/6¾"	14778-17 6,8/7,3 mm	
20,0 cm/8"		14780-20 9,1/11,1 mm



Scharfe Löffel
 Bone Currettes
 Curettes tranchantes
 Cucharillas cortantes

SCHWERT
 SWORD - ESPADA
 EPEE - SPADA



14767

21,0 cm/8¼"

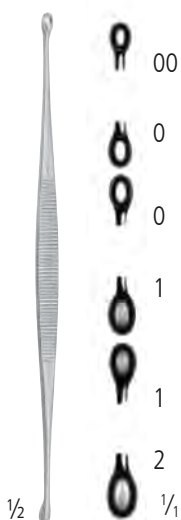

Williger

13,5 cm/5¼"

	Fig.
14762-20	0/00
14762-10	0/1
14762-1	1/2

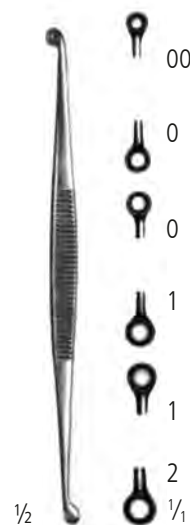

Martini

13,5 cm/5¼"

	Fig.
14760-20	0/00
14760-10	0/1
14760-1	1/2

Scharfe Löffel
Bone Curettes
Curettes tranchantes
Cucharillas cortantes



SCHWERT
SWORD · ESPADA
EPEE · SPADA



Simon
24,0 cm/9½"

	Fig.	mm
14770-1	1	2,2
14770-2	2	2,8
14770-3	3	3,3
14770-4	4	3,7
14770-5	5	4,5
14770-6	6	4,8

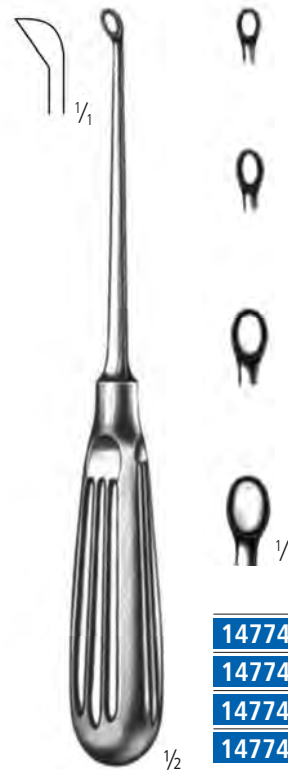

Daubenspeck
20,0 cm/8"

	Fig.	mm
14774-20	00	2,8
14774-10	0	3,8
14774-1	1	5,0
14774-2	2	6,0



25,0 cm/10"

	Fig.	mm
14775-30	000	3,6
14775-20	00	4,4
14775-10	0	5,2
14775-1	1	6,0



25,0 cm/10"

	Fig.	mm
14776-30	000	3,6
14776-20	00	4,4
14776-10	0	5,2
14776-1	1	6,0



Scharfe Löffel
Bone Currettes
Curettes tranchantes
Cucharillas cortantes

SCHWERT
 SWORD - ESPADA
 EPEE - SPADA



	Fig.	mm
14785-0	0	5,0
14785-1	1	6,0
14785-2	2	6,7
14785-3	3	7,0
14785-4	4	8,5

Volkmann
 27,0 cm/10³/₄"



biegsam
flexible
malléable
maleable



	Fig.	mm
14799-1	1	4,8
14799-2	2	5,8
14799-3	3	6,8

Halle
 21,0 cm/8¹/₄"



	Fig.	mm
14798-50	1	1,7
14798-40	2	2,0
14798-30	3	2,4
14798-20	4	2,7
14798-10	5	3,0

Lempert
 21,5 cm/8¹/₂"

Scharfe Löffel
Bone Curettes
Curettes tranchantes
Cucharillas cortantes



SCHWERT
SWORD · ESPADA
EPEE · SPADA



gerade
straight
droits
rectas

Spinal
20,0 cm/8"

Spratt
23,0 cm/9"



gebogen
curved
courbes
curvas

Spinal
20,0 cm/8"

Spratt
23,0 cm/9"

gerade straight droits rectas Fig.										
	20,0 cm/8"	14751-30	14751-20	14751-10	14751-1	14751-2	14751-3	14751-4	14751-5	14751-6
	23,0 cm/9"	14752-30	14752-20	14752-10	14752-1	14752-2	14752-3	14752-4	14752-5	14752-6
gebogen curved courbes curvas Fig.										
	20,0 cm/8"	14753-30	14753-20	14753-10	14753-1	14753-2	14753-3	14753-4	14753-5	14753-6
	23,0 cm/9"	14754-30	14754-20	14754-10	14754-1	14754-2	14754-3	14754-4	14754-5	14754-6



SCHWERT
SWORD - ESPADA
EPEE - SPADA

Raspatorien
Periosteal Raspatories
Rugines-raspatoires
Legras-Periostótomos



Langenbeck

14840

19,0 cm/7½"



Langenbeck

14843

18,0 cm/7"



Sedillot

14854

18,0 cm/7"



14856-1

14,0 cm/4½"



14856-2

14,0 cm/4½"

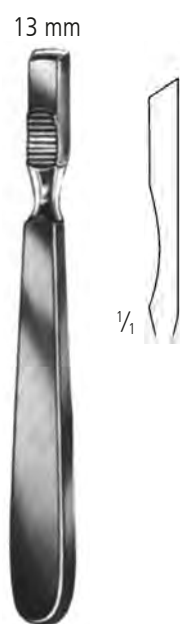

Farabeuf

14832

15,0 cm/6"

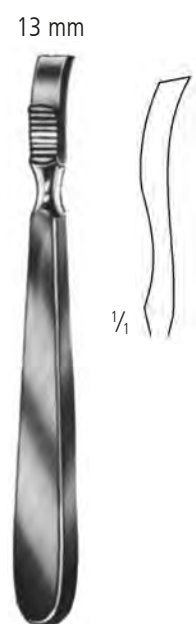

Farabeuf

14833

15,0 cm/6"

Raspatorien
 Periosteal Raspatories
 Rugines-raspatoires
 Legras-Periostótomos



SCHWERT
 SWORD · ESPADA
 EPEE · SPADA



10 mm
 15 mm
 20 mm
 25 mm

- 14865-10** 10 mm
- 14865-15** 15 mm
- 14865-20** 20 mm
- 14865-25** 25 mm

Lambotte
 21,0 cm/8¼"

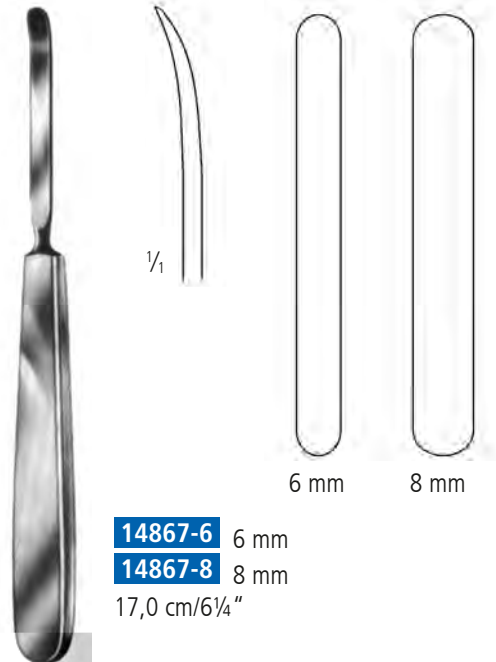

- 14867-6** 6 mm
- 14867-8** 8 mm
- 17,0 cm/6¼"

6 mm 8 mm



5 mm

Williger

14801

13,0 cm/5"



6 mm

Williger

14800

16,0 cm/6¼"



Howarth

21427

21,5 cm/8½"



8 mm

14869-8



17 mm

14869-17



Wagner

33,0 cm/13"



SCHWERT
SWORD · ESPADA
EPEE · SPADA

Raspatorien
Periosteal Raspatories
Rugines-raspatoires
Legras-Periostótomos



Alexander

14873

20,0 cm/8"



Matson

14874

22,0 cm/8¾"



6 mm
12 mm
19 mm
25 mm

leicht gebogen
slightly curved
courbe légèrement
curva ligeramente

14875-6

6 mm

14875-12

12 mm

14875-19

19 mm

14875-25

25 mm

Key

19,0 cm/7½"



14820-2



14821-2

rechts gebogen
curved to the right
courbe à droite
curva a la derecha



Doyen

17,0 cm/6¾"

Doyen

17,0 cm/6¾"

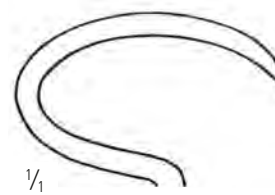

14820-1

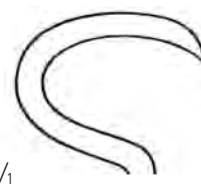

14821-1

links gebogen
curved to the left
courbe à gauche
curva a la izquierda

Raspatorien
 Periosteal Raspatories
 Rugines-raspatoires
 Legras-Periostótomos



SCHWERT
 SWORD · ESPADA
 EPEE · SPADA



Semb

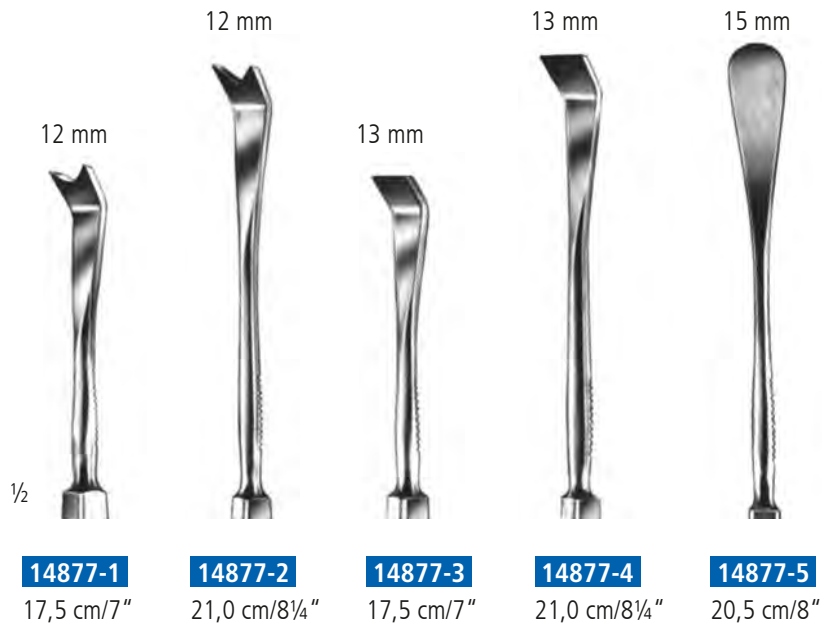

Hylin

14878

14,5 cm/6"

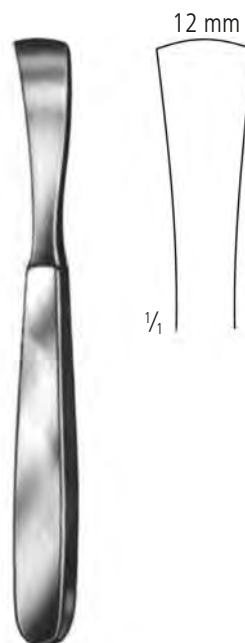

Jansen

14879

17,0 cm/6¾"





SCHWERT
SWORD - ESPADA
EPEE - SPADA

Raspatorien Periosteal Raspatories Rugines-raspatoires Legras-Periostótomos

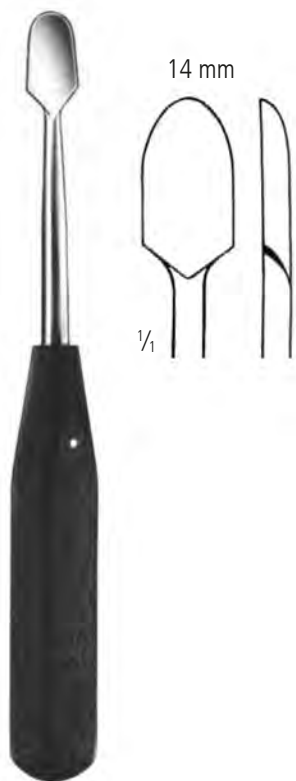

14880-1
20,0 cm/8"

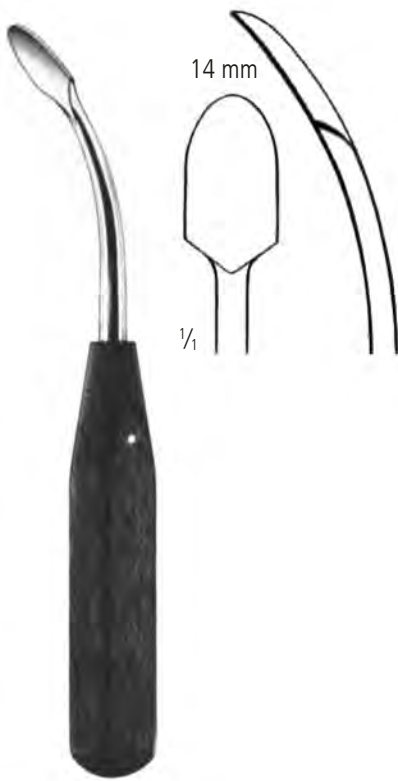

14880-2
20,0 cm/8"

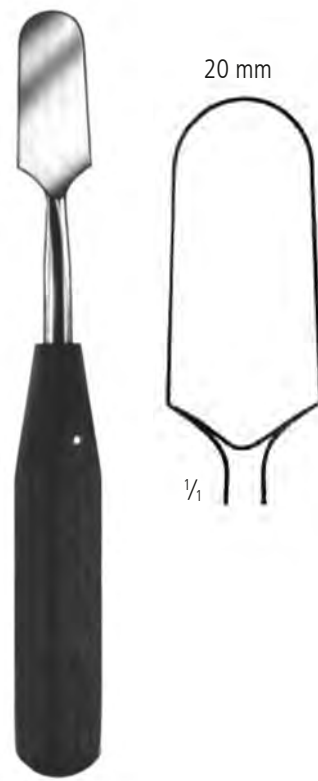

14880-3
20,0 cm/8"



14881-1
18,0 cm/7"

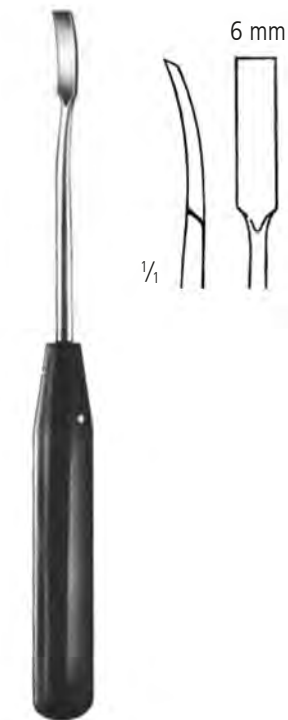

14881-2
18,0 cm/7"

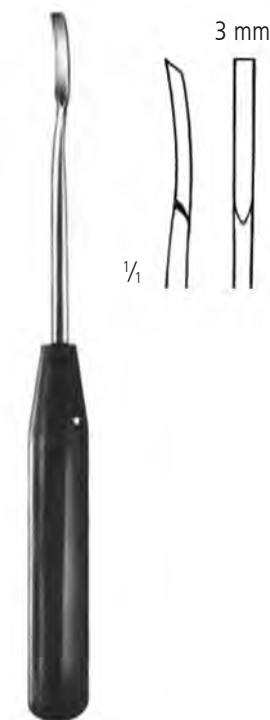

14881-3
18,0 cm/7"

Raspatorien
 Periosteal Raspatories
 Rugines-raspatoires
 Legras-Periostótomos



SCHWERT
 SWORD · ESPADA
 EPEE · SPADA

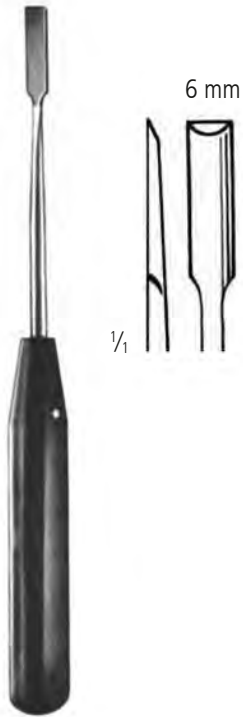

14882
 19,0 cm/7½"

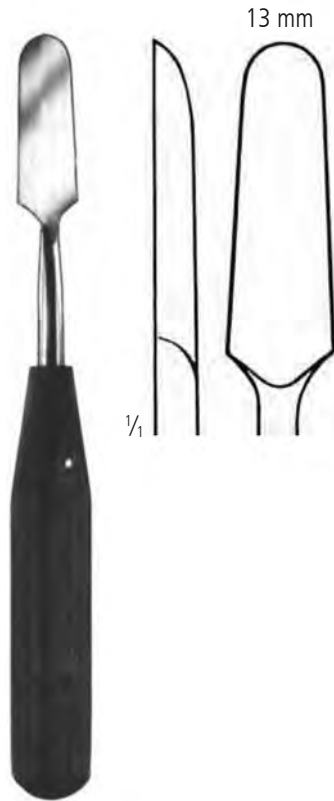

14883
 18,0 cm/7"

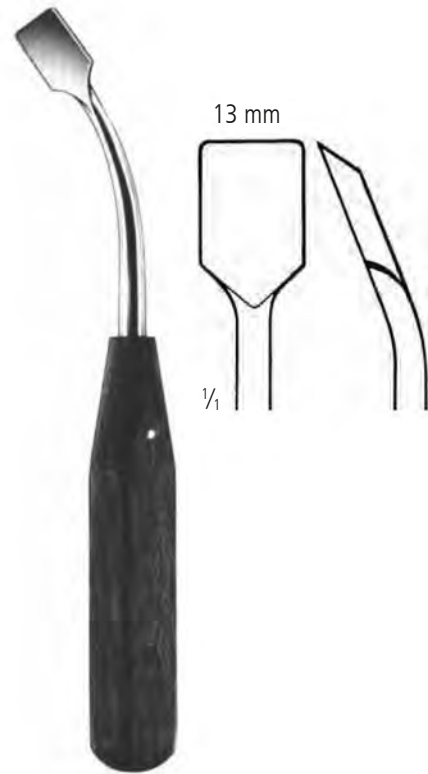

14884
 18,5 cm/7¼"



Obwegeser
 17,5 cm/6¾"

- 14802-1** 6 mm
- 14802-2** 7 mm
- 14802-3** 6 mm
- 14802-4** 11 mm



Adson
 17,0 cm/6¾"



14804-1



14804-2



14804-3



14804-4





SCHWERT
SWORD · ESPADA
EPEE · SPADA

Elevatorien
Elevators
Élévateurs
Elevadores

Raspatorien
Periosteal Raspatories
Rugines-raspatoires
Legras-Periostótomos



Langenbeck

14920

20,0 cm/8"



Langenbeck

14921

20,0 cm/8"

5 mm



Williger

14922

16,0 cm/6¼"

6,5 mm



Williger

14923

17,0 cm/6¾"

6 mm



Quervain

14924

19,5 cm/7¾"

6 mm



6 mm

McDonald

14925

19,0 cm/7½"

4 mm



Joseph

21405

16,5 cm/6½"

Raspatorien
Periosteal Raspatories
Rugines-raspatoires
Legras-Periostótomos

Sehneninstrumente
Tendon Instruments
Instrumentes pour les tendons
Instrumentes para tendones



SCHWERT
 SWORD · ESPADA
 EPEE · SPADA

Sehenschäler
 Tendon stripper
 Instrument à écorcher
 Enucleador de tendones



-  **14985-1**
-  **14985-2**
-  **14985-3**
-  **14985-4**
-  **14985-5**

Bunnell
 15,0 cm/6"



Sehnenführer
 Tendon passing instrument
 Instrument pour passer les tendons
 Instrumento para el tunel del tendón

Bunnell
14986
 23,0 cm/9"



 **14987-15**
 15,0 cm/6"

 **14987-19**
 19,0 cm/7½"

 **14987-24**
 24,0 cm/9½"

Sehnenfazzange
 Tendon seizing instrument
 Instrument pour saisir les tendons
 Instrumento para coger tendones

Brand



Sehnenfazzange
 Tendon seizing instrument
 Instrument pour saisir les tendons
 Instrumento para coger tendones

Carroll
14988
 11,0 cm/4½"



SCHWERT
SWORD - ESPADA
EPEE - SPADA

Knochenfeilen
Bone Files
Limes à os
Limas para huesos



Gallaher
18,0 cm/7"



Fig.1
14935-1



Fig.2
14935-2



Fig.3
14935-3



Joseph
16,0 cm/6½"



Fig.1
14936-1



Fig.2
14936-2



Fig.3
14936-3



14945
24,5 cm/9¾"



13 mm



14944
28,0 cm/11"

20 mm

Knochenfeilen und -raspeln
Bone Files and Rasps
Limes y râpes à os
Limas y raspas para huesos



SCHWERT
SWORD · ESPADA
EPEE · SPADA



14937

22,0 cm/8¾"



Putti

14938

30,0 cm/12"



Putti

14939

27,0 cm/10½"



SCHWERT
SWORD · ESPADA
EPEE · SPADA

Meniskotome
Meniscotomy Knives
Bistouris à ménisques
Bisturries para meniscos



Smillie
17,0 cm/6¾"

Fig. 1
15915-1



Fig. 2
15915-2



Fig. 3
15915-3



Bircher
15917-1
19,0 cm/7½"



Bircher
15917-2
19,0 cm/7½"



15918
18,0 cm/7"

doppelschneidig
double edged
double tranchant
doble cortante



Neff
22,0 cm/8¾"



15919-1

15919-2



Salenius
15920-1
22,0 cm/8¾"



Salenius
15920-2
22,0 cm/8¾"

Knochenheber
Bone Levers
Leviers à os
Elevadores para huesos



SCHWERT
 SWORD · ESPADA
 EPEE · SPADA

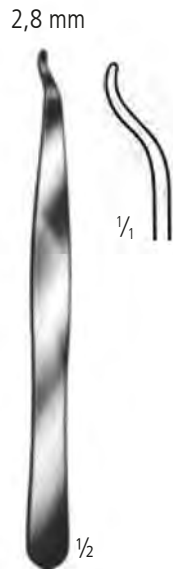

14955-3
 14,0 cm/5½"

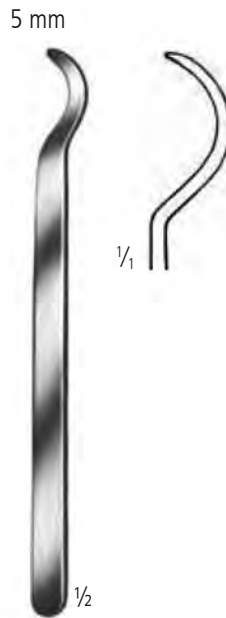

14955-5
 15,0 cm/6"

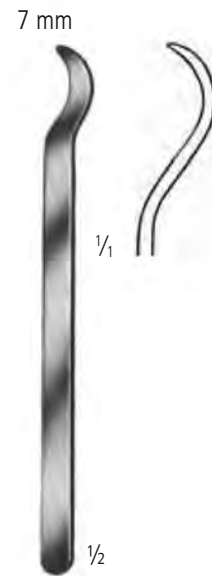

14955-7
 15,0 cm/6"

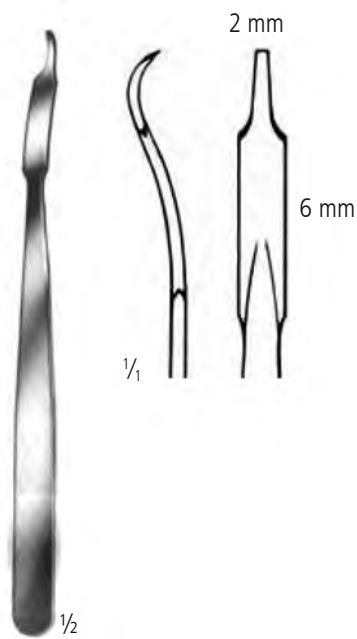

Mini-Hohmann
14961-6
 16,0 cm/6¼"

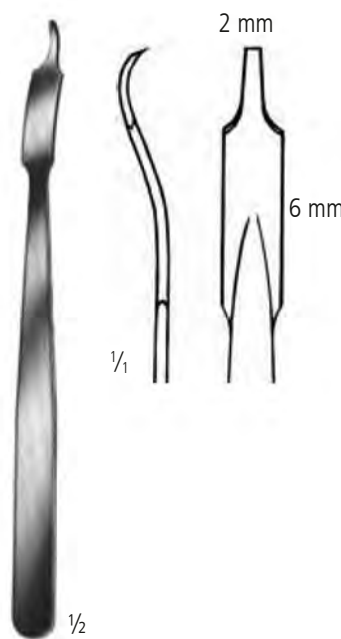

Mini-Hohmann
14961-8
 16,0 cm/6¼"

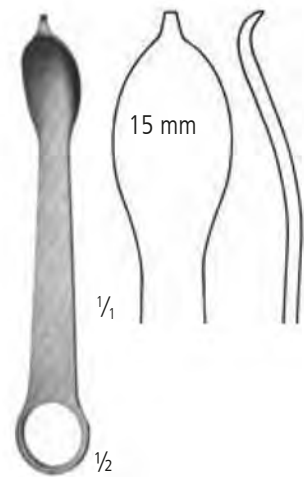

14962
 12,5 cm/5"



SCHWERT
SWORD · ESPADA
EPEE · SPADA

Knochenhebel
Bone Levers
Leviers à os
Elevadores para huesos

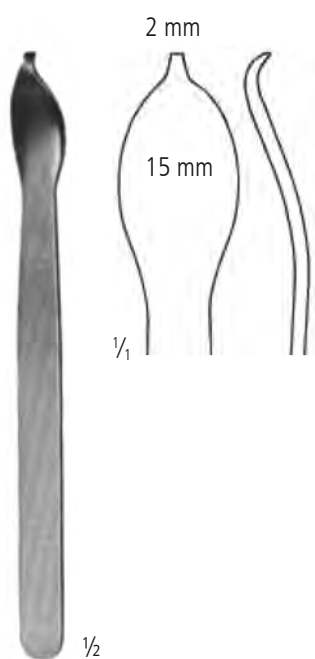

14963
16,0 cm/6¼"



Hohmann
22,0 cm/8¾"
14960-8 8 mm
14960-10 10 mm



Hohmann
24,0 cm/9½"
14960-17 17 mm
spitz, sharp
pointu, agudo
14960-18 18 mm
stumpf, blunt
mousse, romo



Hohmann
24,0 cm/9½"
14960-42

**Knochenheber
Bone Levers
Leviers à os
Elevadores para huesos**



SCHWERT
SWORD · ESPADA
EPEE · SPADA



65 mm

Hohmann
25,5 cm/10"
14960-65



43 mm

Hohmann
24,0 cm/9½"
14960-43



22 mm

Hohmann
26,0 cm/10¼"
14960-22



24 mm

Hohmann
27,0 cm/10¾"
14960-24



34 mm

Hohmann
28,5 cm/11¾"
14960-34



Knochenhebel
Bone Levers
Leviers à os
Elevadores para huesos

SCHWERT
SWORD · ESPADA
EPEE · SPADA

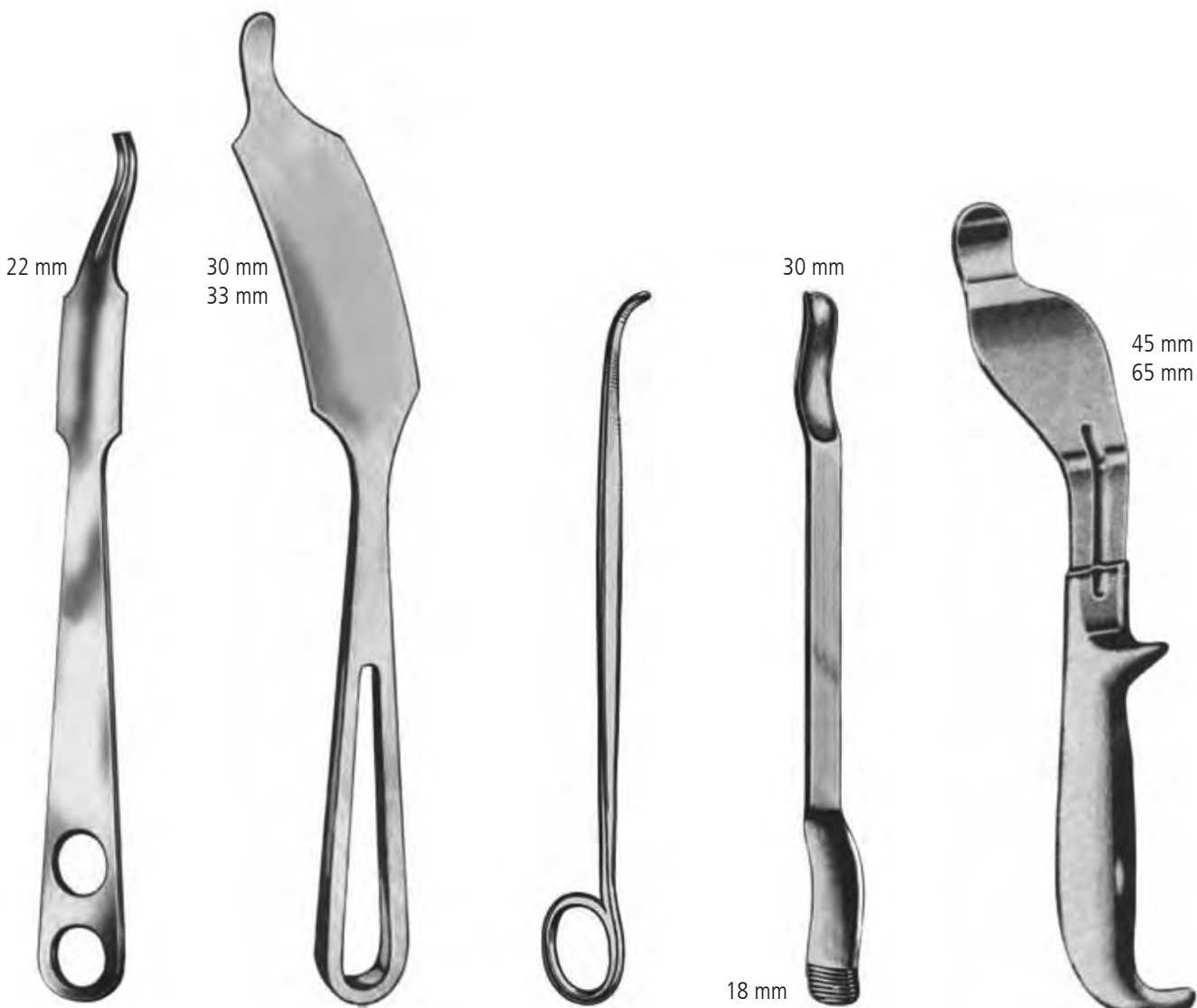

Lange-Hohmann.

14962-22

25,0 cm/10"

Lange-Hohmann modif.

14963-30 30 mm

26,5 cm/10½"

14963-33 33 mm

28,0 cm/11½"

Lane

14966

21,5 cm/8½"

Murphy-Lane

14967

34,0 cm/13½"

Bennett

24,0 cm/9½"

14964-45 45 mm

14964-65 65 mm

Knochenhebel
Bone Levers
Leviers à os
Elevadores para huesos



38 mm

Blount
 26,0 cm/10¼"
14975

Spinalhaken
Spinal retractors
Ecarteurs spinaux
Separadores espinales



Blount
 26,0 cm/10¼"
14976



Meniskushaken
 Meniscus retractors
 Ecarteurs pour le ménisque
 Separadores para menisco

Blount
 17,5 cm/7"
14977



Spinalhaken
 Spinal retractors
 Ecarteurs spinaux
 Separadores espinales

Taylor
 16,5 cm/6½"
14978-7 75 x 30 mm
14978-10 100 x 30 mm



SCHWERT
 SWORD · ESPADA
 EPEE · SPADA



SCHWERT
SWORD · ESPADA
EPEE · SPADA

Hämmer
Mallets
Marteaux
Martillos y Mazos



28 mm Ø
340 g (12 oz.)

Williger
24,0 cm/9½"

14720



14732-25
25 mm Ø
120 g (4¼ oz.)

14732-30
30 mm Ø
180 g (6½ oz.)

14732-35
35 mm Ø
260 g (9 oz.)

Doyen
21,0 cm/8¼"



30 mm Ø
220 g (7¾ oz.)

Collin
20,0 cm/8"

14730



25 mm Ø
260 g (9 oz.)

Lucae
19,0 cm/7½"

14721



20 mm Ø
140 g (5 oz.)

Messing massiv
solid brass
laiton solide
latón macizo

14722

16,5 cm/6½"



20 mm Ø
140 g (5 oz.)

Messing massiv
solid brass
laiton solide
latón macizo

14723

16,5 cm/6½"

**Hämmer
Mallets
Marteaux
Martillos y Mazos**



SCHWERT
SWORD · ESPADA
EPEE · SPADA



26 mm Ø
320 g (11¼ oz.)

14736-5

Ferrozellbacken allein,
paarweise
Ferrozell jaws only,
pair
Plaques en matière Ferrozell,
pair
Tapas de Ferrozell suelas,
par

Mead
17,0 cm/6¾"

14736

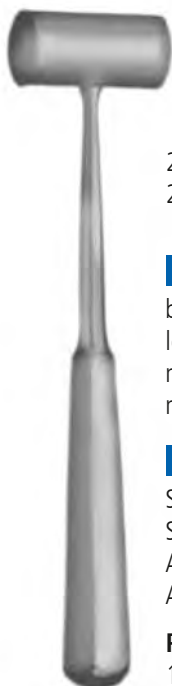

22 mm Ø
200 g (7 oz.)

14728

bleigefüllt
lead filled
rempli de plomb
relleno de plomo

14728-1

Stahl, massiv
Steel, solid
Acier, solide
Acero, macizo

Partsch
18,0 cm/7"



25 mm Ø
140 g (5 oz.)

14737-5

Ferrozellbacken allein,
paarweise
Ferrozell jaws only,
pair
Plaques en matière Ferrozell,
pair
Tapas de Ferrozell suelas,
par

14737

18,5 cm/7¼"



30 mm Ø
240 g (8¾ oz.)

Stahl massiv
mit Leichtmetallgriff
Steel solid
with light metal handle
Acier solide
avec manche en metal
Acero, macizo,
con mango de metal ligero

Cottle
18,5 cm/7¼"

14740



27 mm Ø
140 g (5 oz.)

Hajek
21,5 cm/8½"

14733



SCHWERT
SWORD · ESPADA
EPEE · SPADA

**Hämmer
Mallets
Marteaux
Martillos y Mazos**



30 mm Ø
300 g (10½ oz.)

Bergmann
23,5 cm/9¼"

14741



45 mm Ø
300 g (10½ oz.)

Bergmann
24,5 cm/9¾"

14742



40 mm Ø
550 g (19 oz.)

Ombredanne
24,0 cm/9½"

14743



50 mm Ø
360 g (12½ oz.)

ohne Blei
without lead
sans plomb
sin plomo

14744-50

25,0 cm/10"

Hämmer
Mallets
Marteaux
Martillos y Mazos



42 mm / 30 mm Ø
400 g (14 oz.)

Stahl massiv
mit Leichtmetallgriff
Steel solid
with light metal handle
Acier solide
avec manche en metal
Acero, macizo,
con mango de metal ligero

14745

24,0 cm/9½"



30 mm Ø
450 g (16 oz.)

Stahl, massiv
Steel solid
Acier, solide
Acero, macizo

14746-1

26,5 cm/10½"



45 mm Ø
900 g (32 oz.)

Stahl, massiv
Steel solid
Acier, solide
Acero, macizo

14746-2

26,5 cm/10½"



SCHWERT
SWORD · ESPADA
EPEE · SPADA



SCHWERT
SWORD · ESPADA
EPEE · SPADA

Knochenhalte­zangen
Bone Holding Forceps
Davier à os
Pinzas para huesos



16024

gerade
straight
droite
recta

Sequesterzangen
Sequestum Forceps
Pince à séquestre
Pinza para secuestros



20,0 cm/8"



16025

aufgebogen
curved on flat
courbe vers le haut
curva sobre el plano



16027

14,0 cm/5½"



Knorpelasszange
Cartilage Seizing Forceps
Pince à saisir cartilages
Pinzas para coger cartílagos

Dingmann
19,0 cm/7½"

16049



16097

12,0 cm/4¾"



Lewin
17,5 cm/7"

16064-17

Knochenhaltezangen
Bone Holding Forceps
Davier à os
Pinzas para huesos



SCHWERT
 SWORD · ESPADA
 EPEE · SPADA



gerade
 straight
 droite
 recta

Bircher-Ganske
 20,0 cm/8"

16054



gebogen
 curved
 courbes
 curvas

Bircher-Ganske
 20,0 cm/8"

16055

Knorpelasszange
 Cartilage Seizing Forceps
 Pince à saisir cartilages
 Pinzas para coger cartílagos



Setter

16056-16

16,0 cm/6¼"

16056-24

24,0 cm/9½"



ohne Sperre
 without ratchet
 sans crémaillère
 sin cremallera

Semb

19,0 cm/7½"

16060



mit Sperre
 with ratchet
 avec crémaillère
 con cremallera

Semb

19,0 cm/7½"

16061



SCHWERT
SWORD · ESPADA
EPEE · SPADA

Knochenhalte­zangen
Bone Holding Forceps
Davier à os
Pinzas para huesos



Van Buren

16031

23,0 cm/9"



Langenbeck

16040

21,0 cm/8¼"



Farabeuf

16068-23

23,0 cm/9"

16068-26

26,0 cm/10¼"



Fergusson

21,0 cm/8¼"

16048



Repositionszange
Reposition Forceps
Pince à reduction
Pinza para reposición

16098-13

13,5 cm/5¼"



Farabeuf-Lambotte

26,0 cm/10¼"

16069

mit Sperre
with ratchet
avec crémaillère
con cremallera

Knochenhaltezangen
Bone Holding Forceps
Davier à os
Pinzas para huesos



SCHWERT
 SWORD · ESPADA
 EPEE · SPADA



16063

20,0 cm/8"



16098-20

20,0 cm/8"

Repositionszange
 Reposition Forceps
 Pince à réduction
 Pinza para reposición



16099-21

21,0 cm/8¼"



Baby-Kern

15,0 cm/6"

16085-15

mit Sperre
 with ratchet
 avec crémaillère
 con cremallera

15,0 cm/6"

16084-15

ohne Sperre
 without ratchet
 sans crémaillère
 sin cremallera



SCHWERT
SWORD · ESPADA
EPEE · SPADA

Knochenhaltezaugen Bone Holding Forceps Davier à os Pinzas para huesos



Kern

16085-17

17,0 cm/6¾"

16085-21

21,0 cm/8¼"

mit Sperre
with ratchet
avec crémaillère
con cremallera

16084-17

17,0 cm/6¾"

16084-21

21,0 cm/8¼"

ohne Sperre
without ratchet
sans crémaillère
sin cremallera



Lane

16089-33

33,0 cm/13"

16089-45

45,0 cm/17¾"

mit Sperre
with ratchet
avec crémaillère
con cremallera

16088-33

33,0 cm/13"

16088-45

45,0 cm/17¾"

ohne Sperre
without ratchet
sans crémaillère
sin cremallera



Knochenhaltezangen
Bone Holding Forceps
Davier à os
Pinzas para huesos



SCHWERT
 SWORD · ESPADA
 EPEE · SPADA



Lambotte

16080-22 22,0 cm/8¾"

16080-26 26,0 cm/10¼"

16080-33 33,0 cm/13"

gerade
 straight
 droite
 recta



Lambotte

16081-23 23,0 cm/9"

16081-26 26,0 cm/10¼"

rechtswärts gebogen
 right angled
 courbe à droite
 curva a la derecha



Lambotte

16077-22 22,0 cm/8¾"

16077-27 27,0 cm/10¾"

16077-30 30,0 cm/11¾"

verstellbar
 right adjustable
 ajustable
 ajustable



SCHWERT
SWORD · ESPADA
EPEE · SPADA

Knochenhalte­zangen
Bone Holding Forceps
Davier à os
Pinzas para huesos



Verbrugge

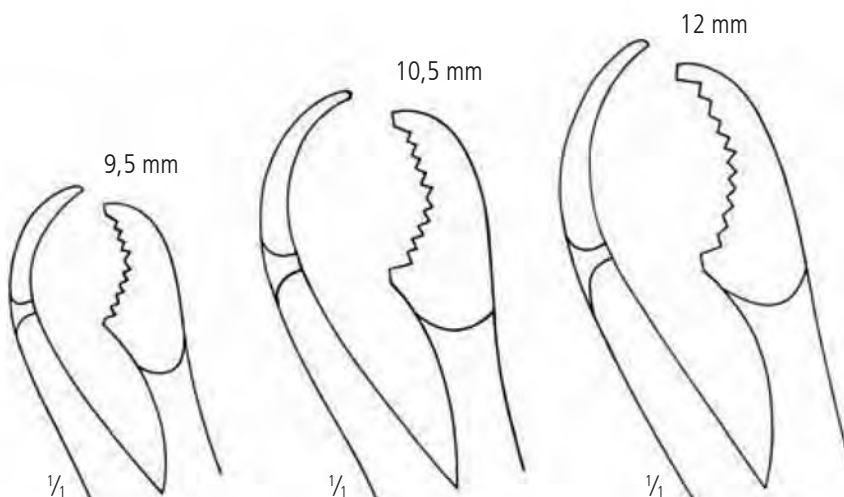

Fig. 1

16090-25
25,0 cm/10"

Fig. 2

16090-26
26,0 cm/10¼"

Fig. 3

16090-27
27,0 cm/10¾"



Verbrugge-Baby



16090-17
17,5 cm/7"

Knochenhaltezangen
Bone Holding Forceps
Davier à os
Pinzas para huesos



SCHWERT
 SWORD · ESPADA
 EPEE · SPADA



Verbrugge

Fig. 00	16091-15	15,0 cm/6"	2,5 mm
Fig. 0	16091-19	19,0 cm/7½"	6,5 mm
Fig. 1	16091-24	24,0 cm/9½"	9,5 mm
Fig. 2	16091-26	26,0 cm/10¼"	10,0 mm
Fig. 3	16091-28	28,0 cm/11"	11,0 mm



Ulrich

16092-23	23,0 cm/9"
16092-25	25,0 cm/10"
16092-28	28,0 cm/11"

gerade
 straight
 droite
 recta



Ulrich

16093-28	28,0 cm/11"
-----------------	-------------

seitwärts gebogen
 curved sideways
 courbe à la côté
 curva lateral



SCHWERT
SWORD · ESPADA
EPEE · SPADA

Hohlmeisselzangen
Bone Rongeur Forceps
Pincès-gouges
Pinzas-gubias

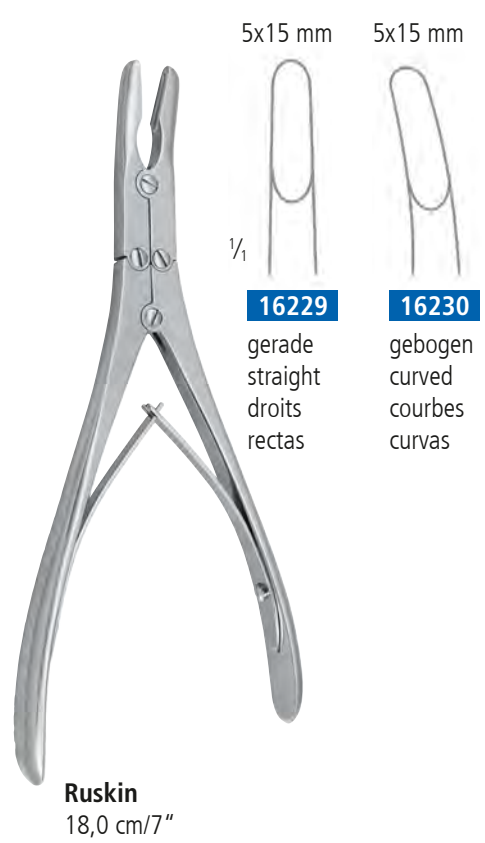
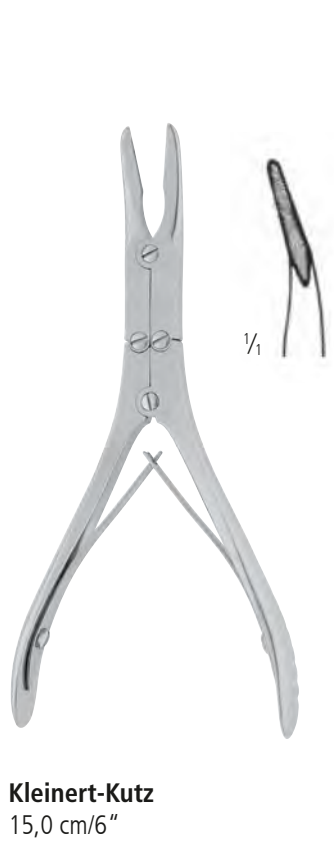
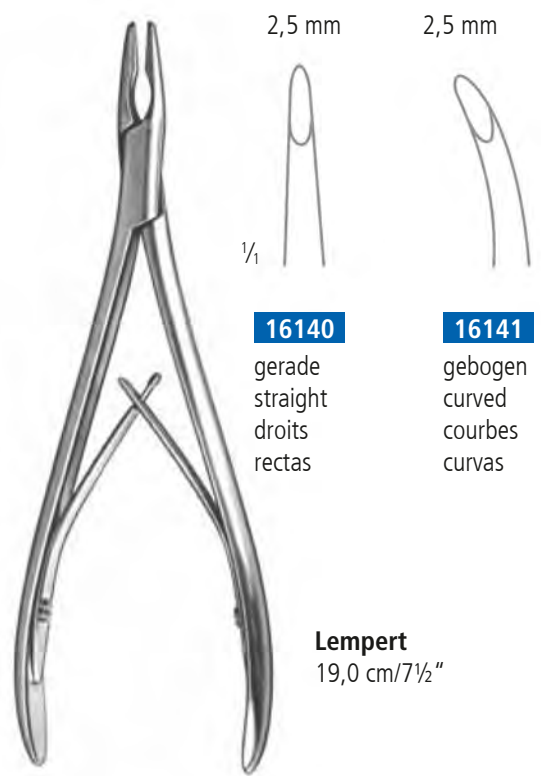
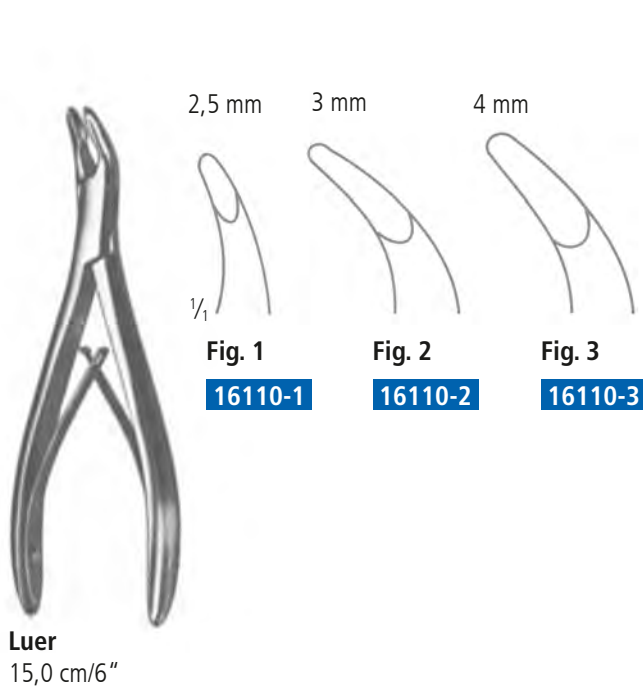

Hohlmeisselzangen
Bone Rongeur Forceps
Pincés-gouges
Pinzas-gubias



SCHWERT
SWORD · ESPADA
EPEE · SPADA

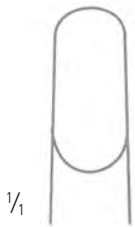

1/1

16242

22,0 cm/8 3/4"

gerade
straight
droits
rectas



16243

22,0 cm/8 3/4"

gebogen
curved
courbes
curvas



17 mm

16246

27,0 cm/10 3/4"

gerade
straight
droits
rectas



17 mm

16247

27,0 cm/10 3/4"

gebogen
curved
courbes
curvas



Stille-Luer



Röttgen-Ruskin

16229-23

23,0 cm/9"

5 mm

1/1

16229-23

gerade
straight
droits
rectas

5 mm

1/1

16230-23

gebogen
curved
courbes
curvas

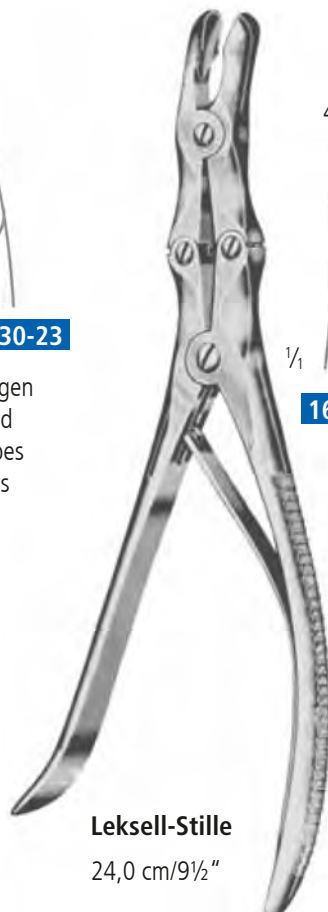

Leksell-Stille

24,0 cm/9 1/2"

4 mm

1/1

16236-4

8 mm

16236-8



Stille

16239

23,0 cm/9"

7 mm

1/1



SCHWERT
SWORD - ESPADA
EPEE - SPADA

Hohlmeisselzangen
Bone Rongeur Forceps
Pincès-gouges
Pinzas-gubias



Luer
17,0 cm/6¾"



16162
gerade
straight
droits
rectas



16163
gebogen
curved
courbes
curvas



Luer-Friedmann
14,0 cm/5½"

16108



Micro-Friedmann
14,0 cm/5½"

16107

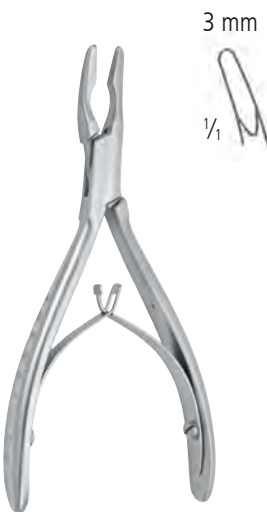

Mini-Friedmann
12,0 cm/5"

16106

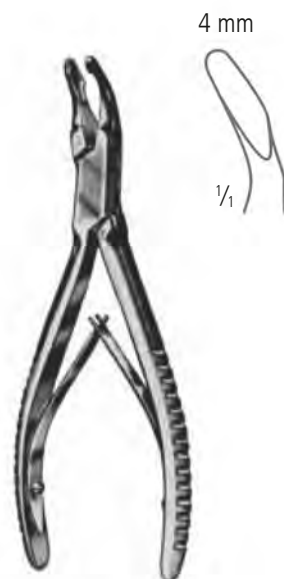

Cleveland
14,0 cm/5½"

16118-14



Cleveland
17,0 cm/6¾"

16118-17



Hohlmeisselzangen
 Bone Rongeur Forceps
 Pincès-gouges
 Pinzas-gubias



SCHWERT
 SWORD · ESPADA
 EPEE · SPADA



2 mm

2 mm

1/1

16185-1

16185-2

Stellbrink
 17,0 cm/6 3/4"



1/1

16132-30

16132-45

16132-90

30°

45°

90°

Blumenthal
 15,5 cm/6"

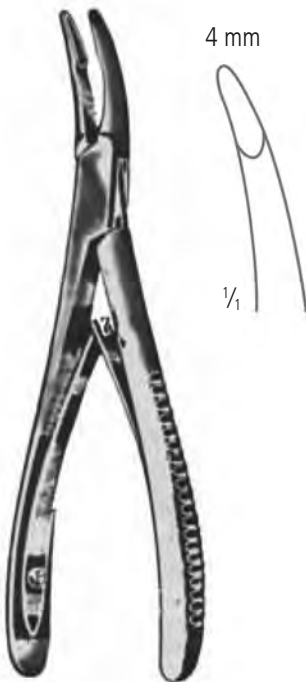

4 mm

1/1

Zaufal
 17,0 cm/6 3/4"

16186



4 mm

4 mm

1/1

16154

gerade
 straight
 droits
 rectas

16155

gebogen
 curved
 courbes
 curvas

Jansen
 17,0 cm/6 3/4"





SCHWERT
SWORD · ESPADA
EPEE · SPADA

Hohlmeisselzangen
Bone Rongeur Forceps
Pinces-gouges
Pinzas-gubias

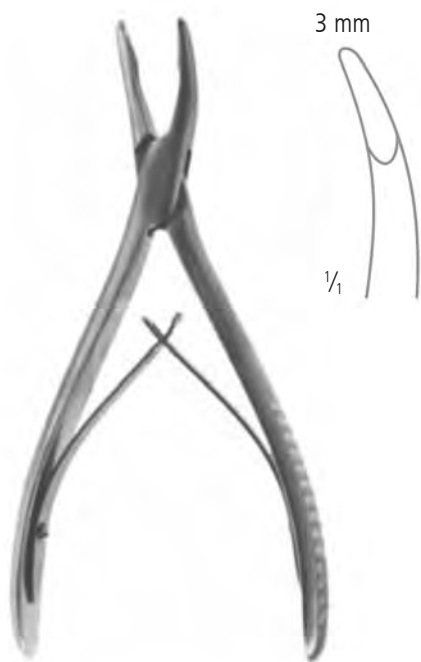

Beyer
18,0 cm/7"

16187

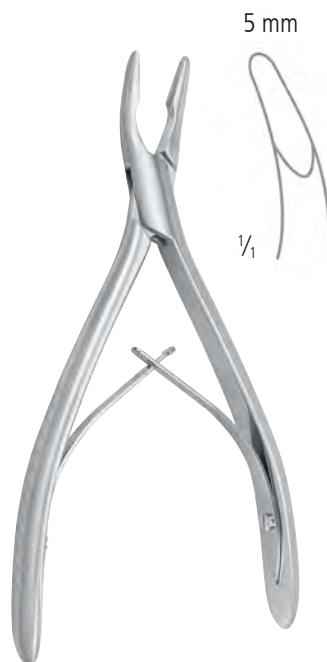

Bane (Hartmann)
17,0 cm/6¾"

16139

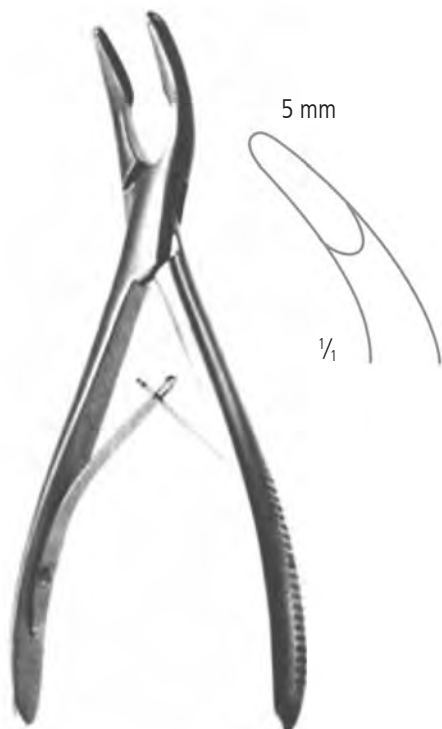

Olivecrona
19,0 cm/7½"

16183

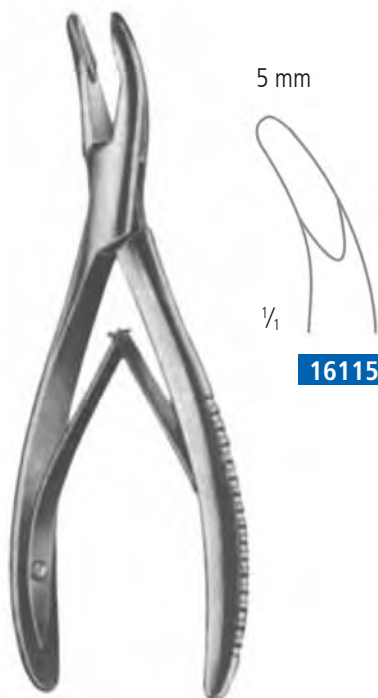

Mead
16,5 cm/6½"

16115



16116

Hohlmeisselzangen
 Bone Rongeur Forceps
 Pincès-gouges
 Pinzas-gubias



SCHWERT
 SWORD · ESPADA
 EPEE · SPADA



Adson
 20,0 cm/8"
16182

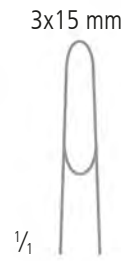

16220
 gerade
 straight
 droits
 rectas



16221
 gebogen
 curved
 courbes
 curvas



16222
 gebogen
 curved
 courbes
 curvas

Böhler
 15,0 cm/6"



Zaufal-Jansen
 18,0 cm/7"
16226

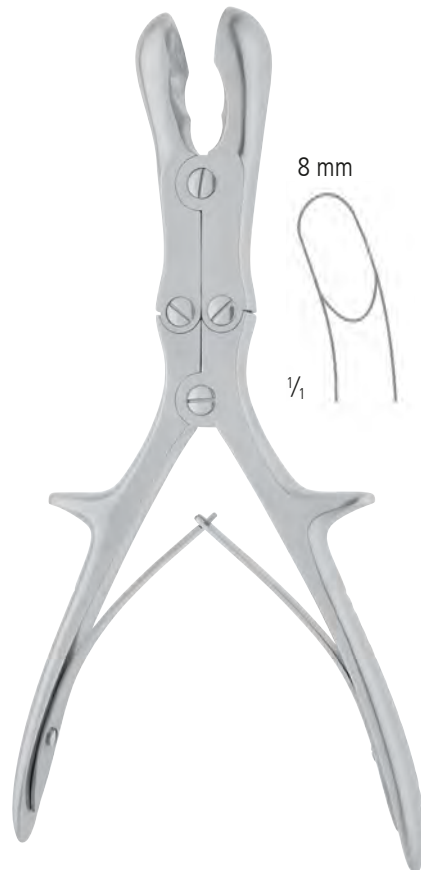

Stille-Ruskin
 23,0 cm/9"
16250

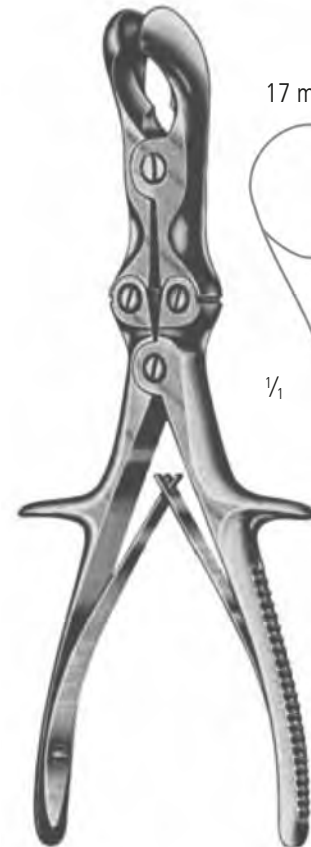

Semb
 22,5 cm/8¾"
16251



SCHWERT
SWORD · ESPADA
EPEE · SPADA

Hohlmeisselzangen
Bone Rongeur Forceps
Pincès-gouges
Pinzas-gubias



3x10 mm



16235-2

3x10 mm



16235-3

4x10 mm



16235-4

1/1

seitwärts gebogen
curved on side
courbe sur le côté
curva lateral

Echlin
23,0 cm/9"



3 mm



16255-1

19,0 cm/7½"

16256-1

24,0 cm/9½"

gerade
straight
droits
rectas

3 mm



16255-2

19,0 cm/7½"

16256-2

24,0 cm/9½"

leicht gebogen
slightly curved
courbe légèrement
curva ligeramente

3 mm



16255-3

19,0 cm/7½"

16256-3

24,0 cm/9½"

stark gebogen
fully curved
courbe fortement
curva fuertemente

Smith-Petersen

Hohlmeisselzangen
 Bone Rongeur Forceps
 Pincès-gouges
 Pinzas-gubias



SCHWERT
 SWORD · ESPADA
 EPEE · SPADA



Sauerbruch
 30,0 cm/11¾"

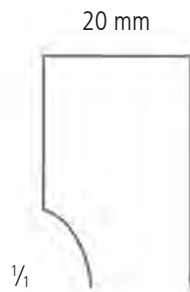

16264



16263



Mayfield
 17,0 cm/6¾"

16258

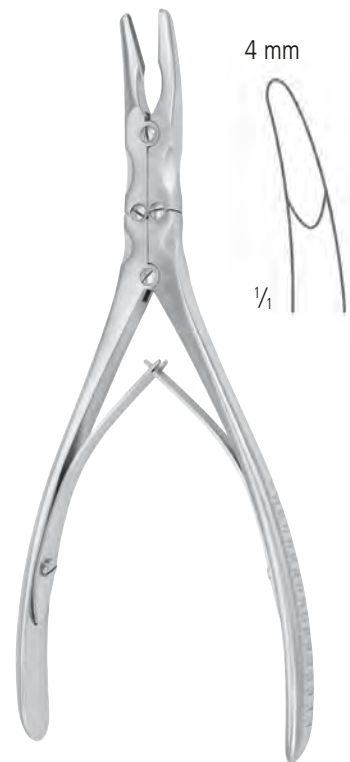

Marquardt
 20,0 cm/8"

16259





SCHWERT
SWORD - ESPADA
EPEE - SPADA

Knochensplitterzangen
Bone Cutting Forceps
Pincès coupantes à os
Pinzas cortantes para huesos



16326-14	14,0 cm/5½"	16329-14
16326-17	17,0 cm/6¾"	16329-17
16326-19	19,0 cm/7½"	16329-19
16326-22	22,0 cm/8¾"	16329-22

gerade
straight
droits
rectas

Liston

gebogen
curved
courbes
curvas



16334	gerade straight droits rectas	16335	gebogen curved courbes curvas
--------------	--	--------------	--

Liston-Mini
15,0 cm/6"



gerade
straight
droits
rectas

Stille-Liston
27,0 cm/10½"

16378



16379
27,0 cm/10½"
gebogen
curved
courbes
curvas



s-förmig
S-shaped
forme en S
en forme de S

Liston-Key
27,0 cm/10½"

16382

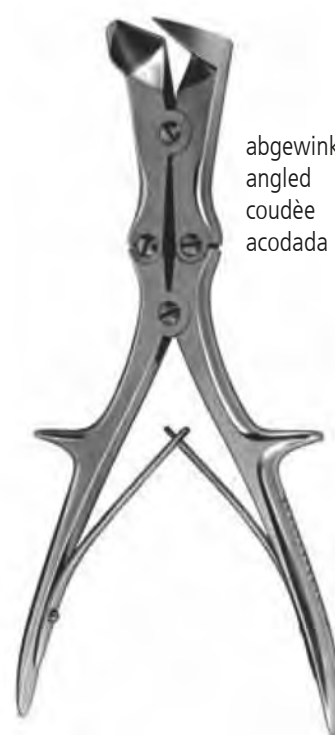

abgewinkelt
angled
coudée
acodada

Stille-Liston
27,0 cm/10½"

16380

Knochensplitterzangen
Bone Cutting Forceps
Pinces coupantes à os
Pinzas cortantes para huesos



SCHWERT
 SWORD · ESPADA
 EPEE · SPADA



16337-15
 15,0 cm/6"



16337-17
 17,0 cm/6¾"

Cleveland

gebogen
 curved
 courbes
 curvas



16360

gerade
 straight
 droits
 rectas



16361

nach vorn gebogen
 curved forward
 courbe en avant
 curva hacia delante



16362

nach hinten gebogen
 curved backward
 courbe en arrière
 curva hacia atrás



16369

gebogen
 curved
 courbes
 curvas

Böhler
 15,0 cm/6"

Mc Indoe
 17,0 cm/6¾"



SCHWERT
SWORD · ESPADA
EPEE · SPADA

Knochensplitterzangen
Bone Cutting Forceps
Pinces coupantes à os
Pinzas cortantes para huesos

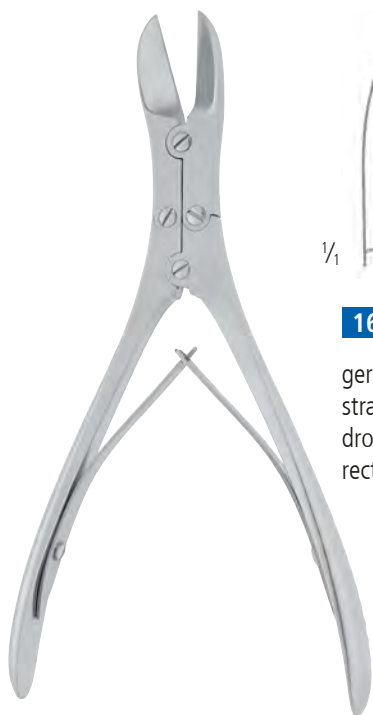

Ruskin
18,0 cm/7"



16364

gerade
straight
droits
rectas



16365

gebogen
curved
courbe
curva



Ruskin-Liston
18,0 cm/7"



16366

gerade
straight
droits
rectas



16367

gebogen
curved
courbe
curva



Semb
23,0 cm/9"

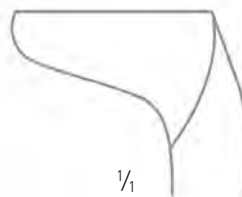

seitwärts gebogen
sideways curved
courbe sur le côté
curva al lado

16375

Knochenhalteklammern
Bone Holding Clamps
Pinces porte-os
Pinzas porta-huesos



SCHWERT
SWORD · ESPADA
EPEE · SPADA

1x2



Lowman

- 14360-12** 12,0 cm/4¾"
- 14360-18** 18,0 cm/7"
- 14360-20** 20,0 cm/8"
- 14360-22** 22,0 cm/8¾"



Lowman-Baby

- 13,0 cm/4¾"
- 14365-13**

Lowman-Hoglund

- 18,0 cm/7"
- 14365-18**



SCHWERT
SWORD · ESPADA
EPEE · SPADA

Wundhaken, Wundsperrer Retractors Ecarteurs Separadores



**Wundhaken
Retractors
Ecarteurs
Separadores**



SCHWERT
SWORD · ESPADA
EPEE · SPADA



16,0 cm/6½"

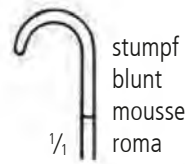
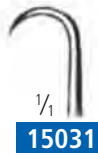
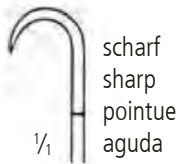

16,0 cm/6½"

flexibel
flexible
flexible
flexible

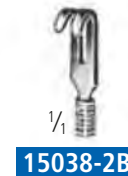
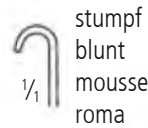
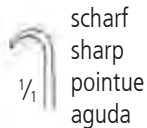



SCHWERT
SWORD - ESPADA
EPEE - SPADA

**Wundhaken
Retractors
Ecarteurs
Separadores**



16,0 cm/6½"

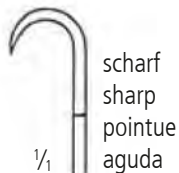

1/1



1/1

15040-1A



1/1

15040-2A



1/1

15040-3A



1/1

15040-4A

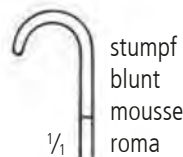

1/1



1/1

15040-1B



1/1

15040-2B



1/1

15040-3B



1/1

15040-4B



Meyerding
18,0 cm/7"

18x7 mm



Fig. 1

15042-1

16x5 mm



Fig. 2

15042-2

7x4 mm



Fig. 3

15042-3

10x3 mm



Fig. 4

15042-4

7x4 mm



Fig. 5

15042-5

10x4 mm



Fig. 6

15042-6

Wundhaken
Retractors
Ecarteurs
Separadores



SCHWERT
SWORD · ESPADA
EPEE · SPADA

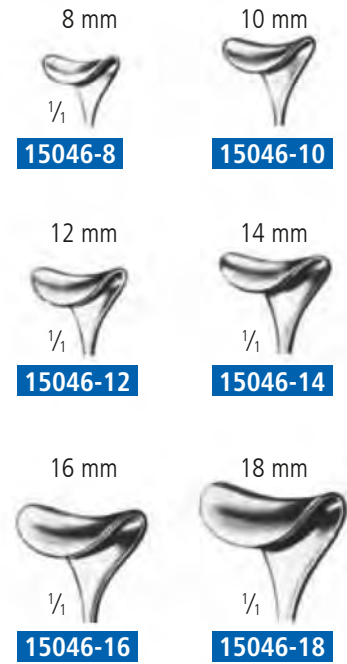
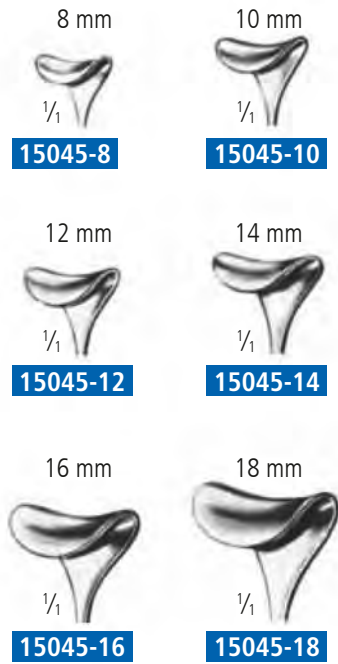



SCHWERT
SWORD · ESPADA
EPEE · SPADA

**Wundhaken
Retractors
Ecarteurs
Separadores**

Sehnenscheidenhaken
Tendon Sheath Retractors
Ecarteurs pour la gaine
Separadores para tendones



Crile
11,0 cm/4¼"
15048



Klapp
17,5 cm/7"
15062



15062

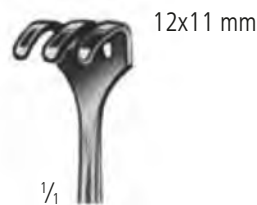

15063



Mini-Langenbeck
16,0 cm/6½"



15075-10

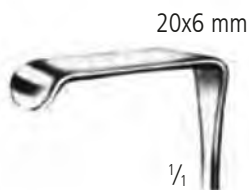

15075-20



15075-17



15075-22

**Wundhaken
Retractors
Ecarteurs
Separadores**



SCHWERT
SWORD · ESPADA
EPEE · SPADA

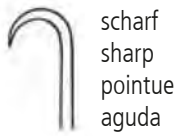

scharf
sharp
pointue
aguda

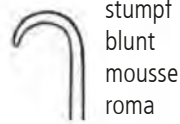

stumpf
blunt
mousse
roma



Volkmann
11,5 cm/4½"



15079-2A



15079-4A



15079-2B



15079-4B



15079-3A

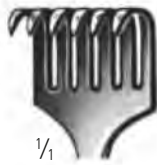

15079-6A



15079-3B



15079-6B



Strandell-Stille
19,0 cm/7½"

15120



gezahnt
toothed
dentele
dentado

Strandell-Stille
19,0 cm/7½"

15121



Dekompressionshaken
Decompression hook
Ecarteur de décompression
Separador para descompresión

Cushing
20,0 cm/8"

15122





SCHWERT
SWORD - ESPADA
EPEE - SPADA

**Wundhaken
Retractors
Ecarteurs
Separadores**



1/2

Volkmann
23,0 cm/9"



1/1

15081-A

scharf
sharp
pointue
aguda



1/1

15081-B

stumpf
blunt
mousse
roma



1/1

15082-A



1/1

15084-A



1/1

15082-B



1/1

15084-B



1/1

15083-A



1/1

15086-A



1/1

15083-B



1/1

15086-B



Volkmann
21,5 cm/8 1/2"

15091-A

scharf
sharp
pointue
aguda



1/1

15092-A



1/1

15094-A

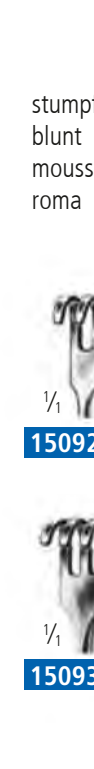

Volkmann
21,5 cm/8 1/2"

15091-B

stumpf
blunt
mousse
roma



1/1

15092-B



1/1

15094-B



1/1

15093-A



1/1

15096-A



1/1

15093-B



1/1

15096-B



**Wundhaken
Retractors
Ecarteurs
Separadores**



SCHWERT
SWORD · ESPADA
EPEE · SPADA



scharf
sharp
pointue
aguda

Volkman
21,5 cm/8½"

15101-A



stumpf
blunt
mousse
roma

Volkman
21,5 cm/8½"

15101-B



stumpf
blunt
mousse
roma

15102-A

24,5 cm/10"



scharf
sharp
pointue
aguda



15121-A



15122-A



15123-A



15124-A



15126-A

stumpf
blunt
mousse
roma



15121-B



15122-B



15123-B



15124-B



15126-B

Kocher
22,0 cm/8½"



SCHWERT
SWORD - ESPADA
EPEE - SPADA

**Wundhaken
Retractors
Ecarteurs
Separadores**



Koerte
23,5 cm/9¼"



1/1

15181

scharf
sharp
pointue
aguda

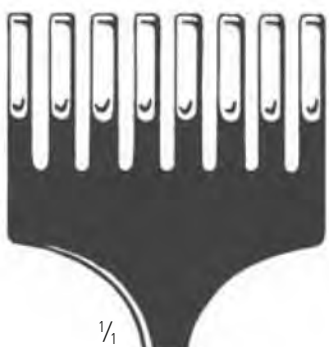

1/1

15180

stumpf
blunt
mousse
roma



36x30 mm

36x60 mm

1/2

15131-30

15131-60

33x20 mm



Wassmund
20,5 cm/8"

15132

1/2

Ollier
22,5 cm/9"

1/2



Wundhaken
Retractors
Ecarteurs
Separadores



SCHWERT
SWORD · ESPADA
EPEE · SPADA



Israel
25,0 cm/10"

40x40 mm

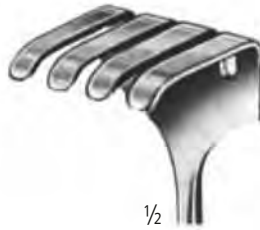

1/2

15204

45x50 mm



1/2

15205

50x60 mm



1/2

15206

70x70 mm

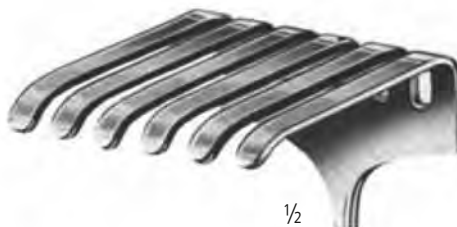

1/2

15206-70



SCHWERT
SWORD · ESPADA
EPEE · SPADA

**Wundhaken
Retractors
Ecarteurs
Separadores**



1/2

Langenbeck
21,0 cm/8 1/4"

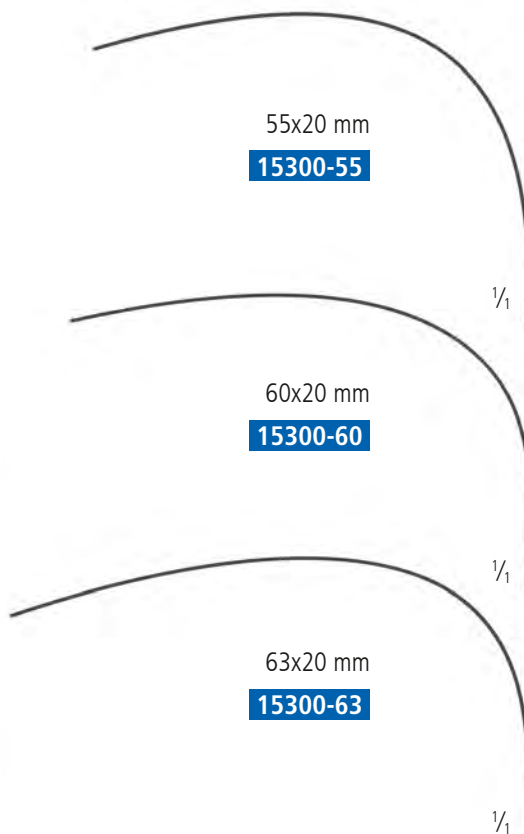

Hüftgelenkhaken
Retractors
Ecarteurs
Separadores



Kocher
21,5 cm/8 1/2"

15314-1	40x18 mm
15314-2	60x20 mm
15314-3	60x25 mm
15314-4	75x30 mm
15314-5	75x40 mm



Langenbeck
21,0 cm/8 1/4"

15315-1	30x11 mm
15315-2	30x14 mm
15315-3	30x16 mm
15315-4	40x11 mm
15315-5	50x11 mm

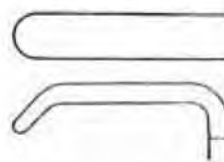

Kocher-Langenbeck
21,5 cm/8 1/2"

15317-50	25x6 mm
15317-30	35x8 mm
15317-20	35x11 mm
15317-0	35x15 mm
15317-1	40x11 mm
15317-2	55x11 mm
15317-3	70x14 mm
15317-4	80x12 mm
15317-5	80x16 mm



1/2

Kocher-Langenbeck
21,5 cm/8 1/2"

**Wundhaken
Retractors
Ecarteurs
Separadores**



SCHWERT
SWORD · ESPADA
EPEE · SPADA



Langenbeck
22,0 cm/8¾"



15310-1 30x11 mm
15310-2 30x14 mm
15310-3 30x16 mm



15310-4 40x11 mm



Sauerbruch
22,5 cm/9"

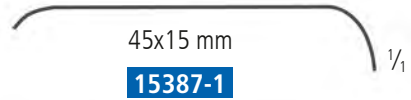

45x15 mm

15387-1

1/1

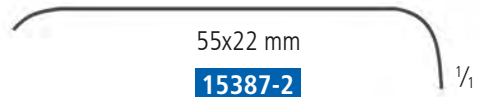

55x22 mm

15387-2

1/1



72x19 mm

15387-3

1/1



Wundhaken
Retractors
Ecarteurs
Separadores

SCHWERT
SWORD · ESPADA
EPEE · SPADA

28x6 mm



Lahey
19,0 cm/7½"

15389

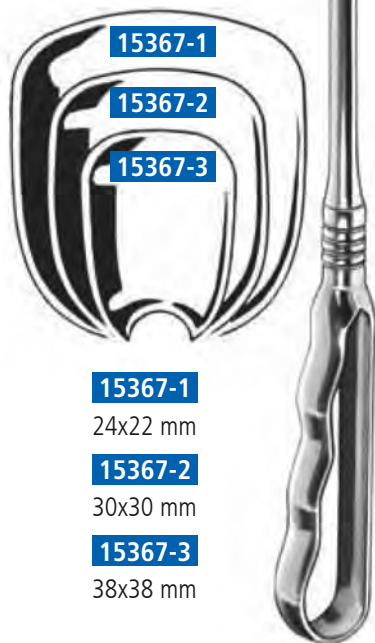

15367-1
24x22 mm
15367-2
30x30 mm
15367-3
38x38 mm

Richardson
24,0 cm/9½"

48x21 mm



Richardson
24,0 cm/9½"

15367-4

65x20 mm

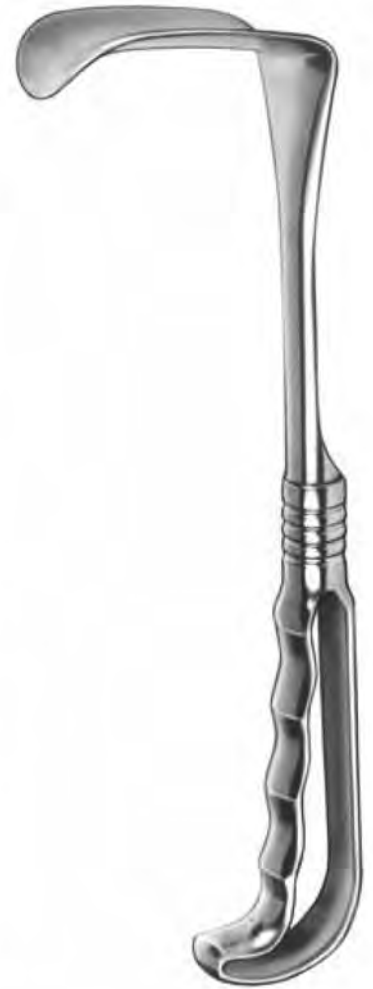

Kelly
26,0 cm/10¼"

15367-15

Wundhaken
Retractors
Ecarteurs
Separadores



SCHWERT
SWORD · ESPADA
EPEE · SPADA



Fig. 1

15371-1

26,0 cm/10 $\frac{1}{4}$ "

Fig. 2

15371-2

28,0 cm/11"

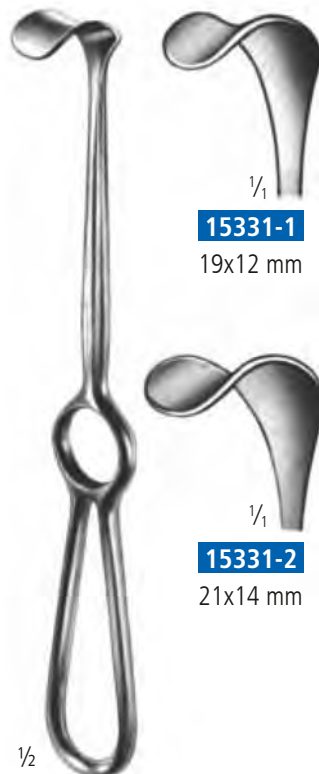

15331-1

19x12 mm

15331-2

21x14 mm



Kocher

22,0 cm/8 $\frac{3}{4}$ "

15331-10

40x10 mm

15331-11

40x15 mm

15331-3

40x20 mm

Richardson-Eastman

15371-S

Satz 2-teilig

Set of 2 pieces

Jeu de 2 pièces

Juego de 2 piezas

Kocher

20,5 cm/8"



SCHWERT
SWORD · ESPADA
EPEE · SPADA

**Wundhaken
Retractors
Ecarteurs
Separadores**

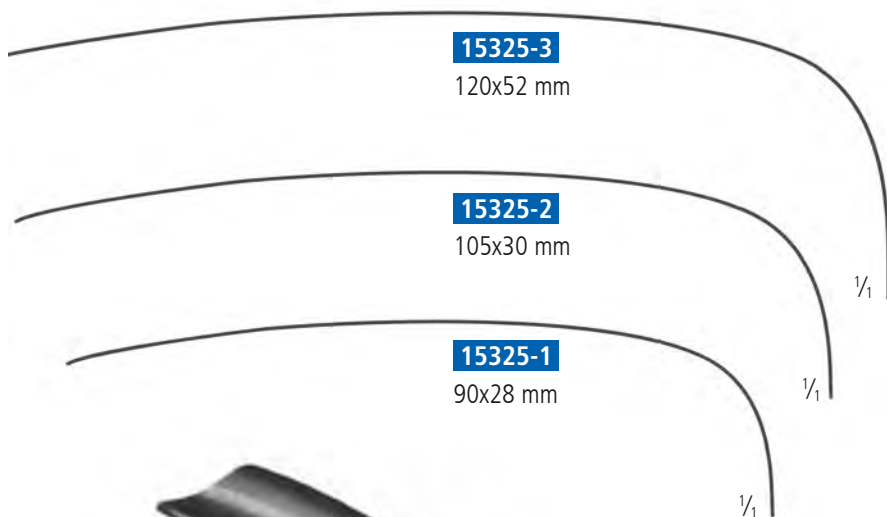

Middeldorpf



15323-1
14x17 mm
26,0 cm/10¼"



15323-2
20x22 mm
22,0 cm/8¾"



15323-3
26x30 mm
23,5 cm/9½"



Doyen-Style
22,0 cm/8¼"

Wundhaken
Retractors
Ecarteurs
Separadores



SCHWERT
SWORD · ESPADA
EPEE · SPADA



Fritsch
24,0 cm/9½"



Middeldorpf
27,5 cm/11"



½

15622-1
45x45 mm



½

15622-2
45x50 mm



½

15622-3
55x70 mm

- 15620-1 Fig.1 40x40 mm
- 15620-1A Fig.2 40x50 mm
- 15620-2 Fig.3 40x60 mm
- 15620-3 Fig.4 40x75 mm



Wundhaken
Retractors
Ecarteurs
Separadores

SCHWERT
SWORD - ESPADA
EPEE - SPADA

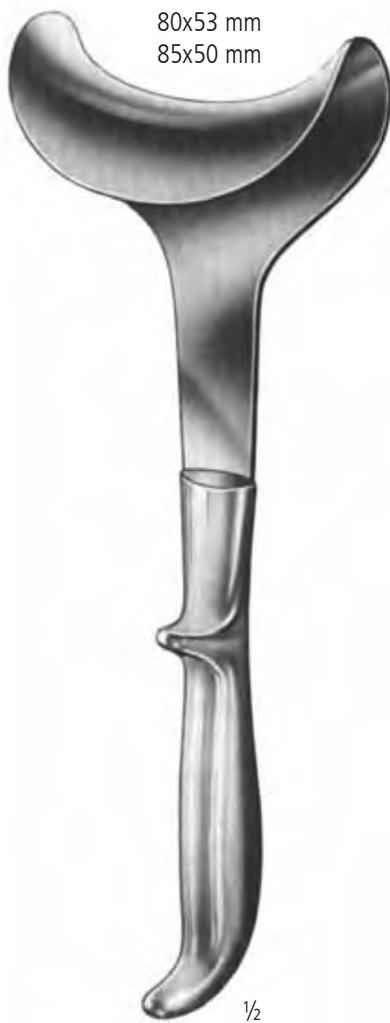

80x53 mm
85x50 mm

1/2

Doyen
25,0 cm/10"

15629 53x80 mm
15630 50x85 mm



70x25 mm

1/2

Kocher
23,5 cm/9 1/4"

15632

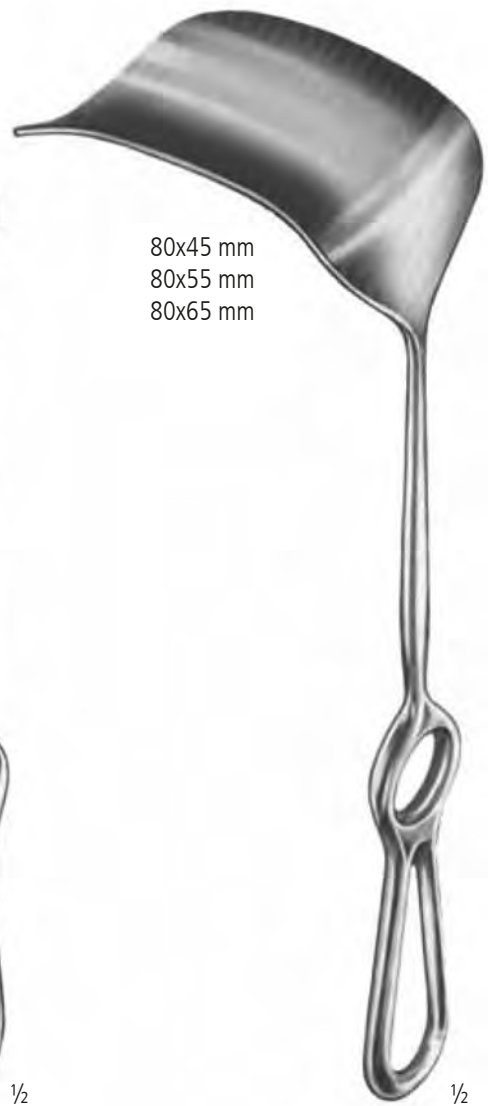

80x45 mm
80x55 mm
80x65 mm

1/2

Kocher
25,0 cm/10"

15633-1 80x25 mm
15633-2 80x55 mm
15633-3 80x65 mm

Wundhaken
Retractors
Ecarteurs
Separadores



SCHWERT
SWORD · ESPADA
EPEE · SPADA



Hösel
25,0 cm/10"

1/2



15635-1
60x20 mm

1/4

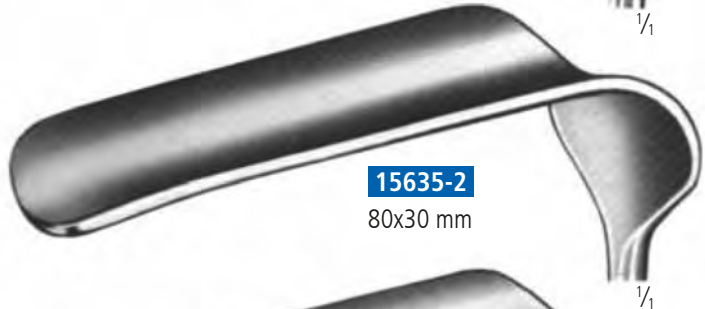

15635-2
80x30 mm

1/4

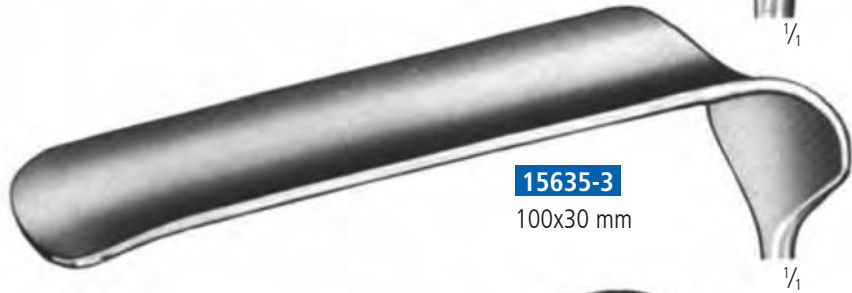

15635-3
100x30 mm

1/4



15635-4
120x30 mm

1/4



15635-5
140x30 mm

1/4



15635-6
140x40 mm

1/4



Wundhaken
Retractors
Ecarteurs
Separadores

SCHWERT
SWORD · ESPADA
EPEE · SPADA



Zenker

1/2

35x8 mm

15636-1

23,5 cm/9 1/4"

1/1

60x12 mm

15636-2

26,0 cm/10 1/4"

1/1

75x12 mm

15636-3

27,5 cm/10 3/4"

1/1

120x12 mm

15636-4

29,0 cm/11 1/2"

1/1

Wundhaken
Retractors
Ecarteurs
Separadores



SCHWERT
SWORD · ESPADA
EPEE · SPADA

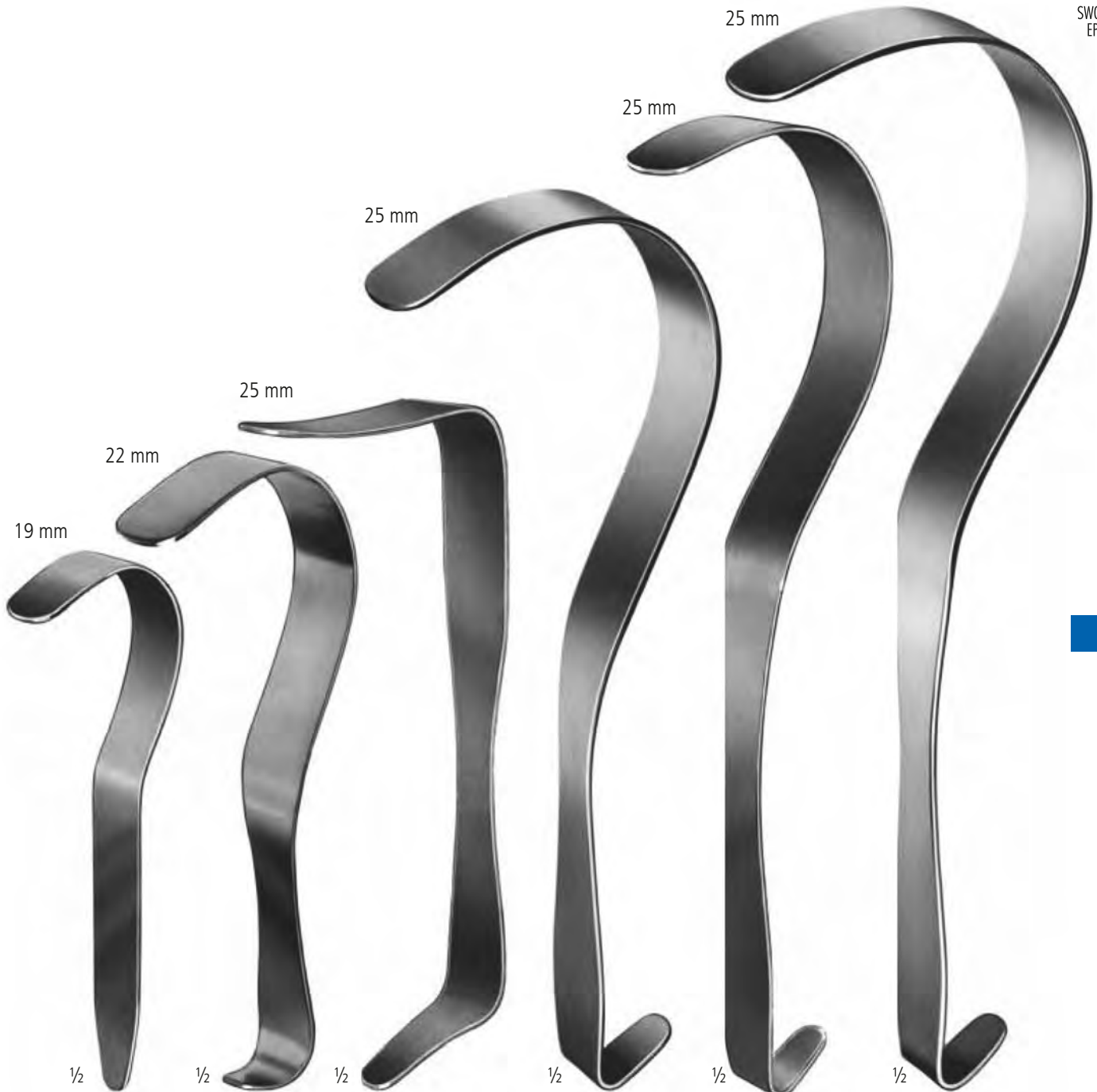

Deaver
18,0 cm/7"

15415-1

Deaver
21,5 cm/8½"

15415-2

Deaver
23,0 cm/9"

15416

Deaver
30,0 cm/12"

15419-1

Deaver
33,0 cm/13"

15419-2

Deaver
36,0 cm/14"

15419-3



Wundhaken
Retractors
Ecarteurs
Separadores

SCHWERT
SWORD · ESPADA
EPEE · SPADA



30 mm

Deaver
30,0 cm/12"

15418-1



50 mm

Deaver
30,0 cm/12"

15418-2



75 mm

Deaver
30,0 cm/12"

15418-3



Harrington
32,0 cm/12½"

15441-1 127x40 mm
15441-2 127x62 mm

Wundhaken
Retractors
Ecarteurs
Separadores



SCHWERT
SWORD · ESPADA
EPEE · SPADA

115x22 mm
115x26 mm



Simon
27,5 cm/10 $\frac{3}{4}$ "
25935-1 115x22 mm
25935-2 115x26 mm

95x20 mm



Modell Tübingen
26,5 cm/10 $\frac{1}{2}$ "
15401

105x27 mm



Martin
25,0 cm/10"
15402



Wundhaken
Retractors
Ecarteurs
Separadores

SCHWERT
SWORD · ESPADA
EPEE · SPADA



Wundhaken
Retractors
Ecarteurs
Separadores



SCHWERT
SWORD · ESPADA
EPEE · SPADA

15399-1
75x50 mm



15399-2
75x90 mm



Davidson
16,0 cm/6¼"



125x37 mm

¼

Sauerbruch
25,0 cm/10"

15397

½



SCHWERT
SWORD · ESPADA
EPEE · SPADA

**Wundhaken
Retractors
Ecarteurs
Separadores**

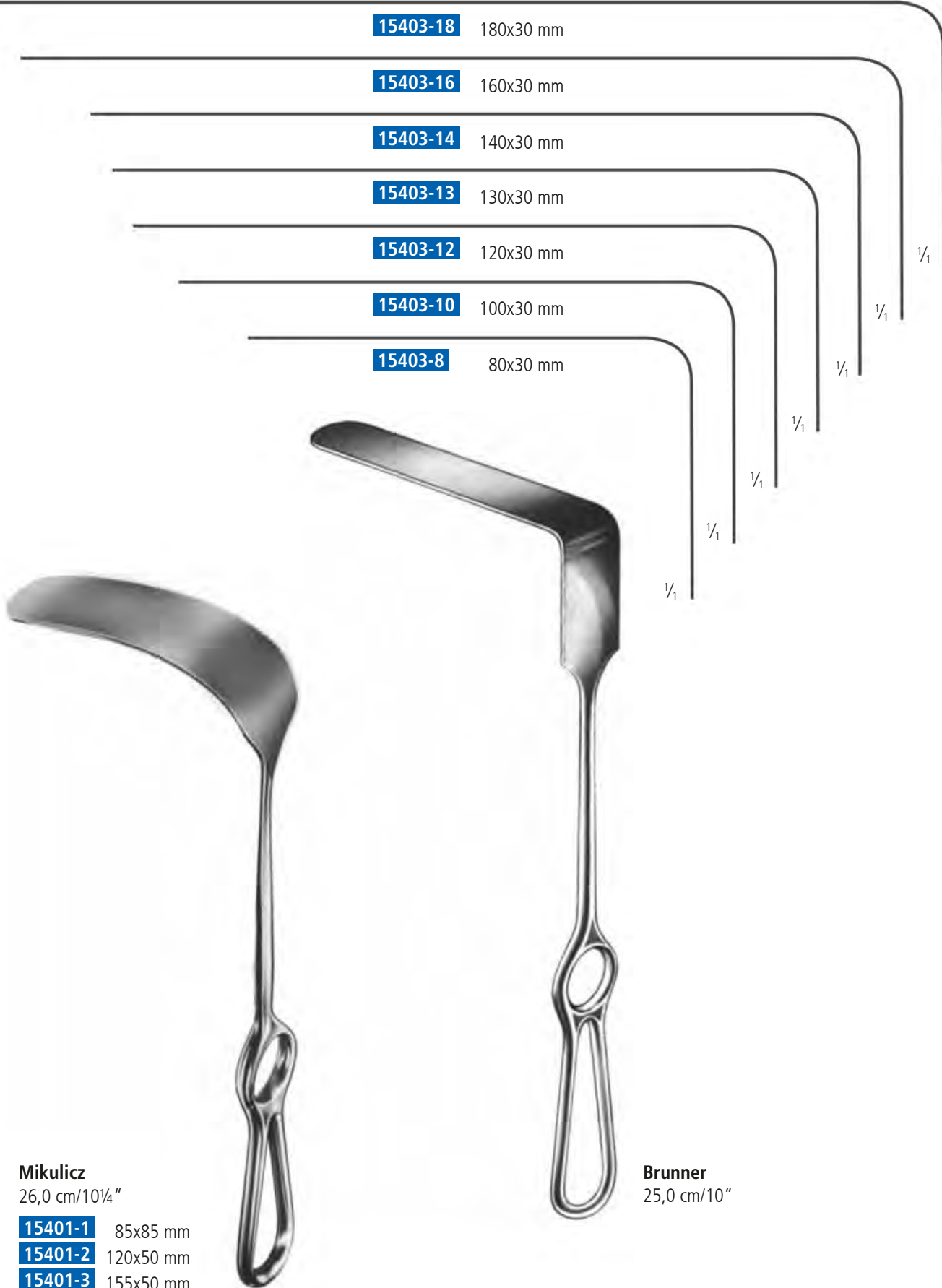

15403-18 180x30 mm

15403-16 160x30 mm

15403-14 140x30 mm

15403-13 130x30 mm

15403-12 120x30 mm

15403-10 100x30 mm

15403-8 80x30 mm

Mikulicz
26,0 cm/10¼"

15401-1 85x85 mm

15401-2 120x50 mm

15401-3 155x50 mm

Brunner
25,0 cm/10"



Wundhaken
Retractors
Ecarteurs
Separadores



SCHWERT
SWORD · ESPADA
EPEE · SPADA

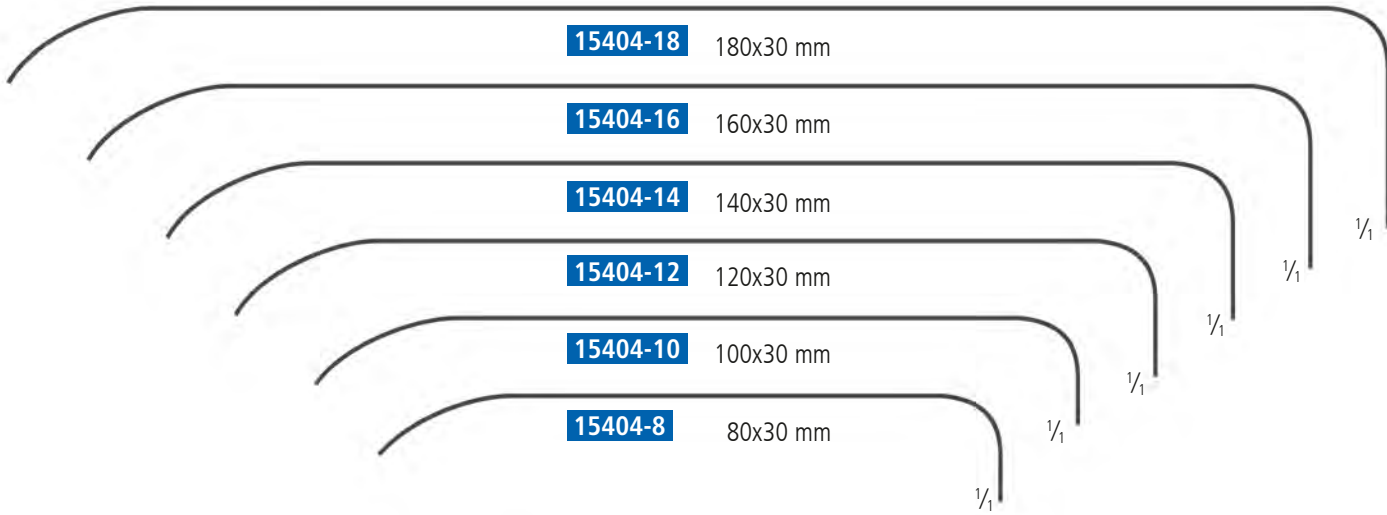

Brunner
25,0 cm/10"



**Wundhaken
Retractors
Ecarteurs
Separadores**

SCHWERT
SWORD · ESPADA
EPEE · SPADA



Wundhaken
Retractors
Ecarteurs
Separadores



SCHWERT
SWORD · ESPADA
EPEE · SPADA

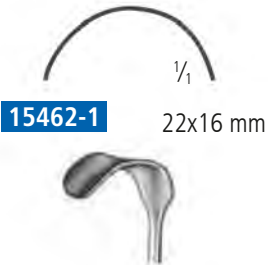

15462-1 22x16 mm



15462-2 38x20mm



15462-3 67x25mm



15462-4 100x35mm

Kocher-Wagner
28,0 cm/11"



SCHWERT
SWORD · ESPADA
EPEE · SPADA

**Wundhaken
Retractors
Ecarteurs
Separadores**



Kelly
27,0 cm/10½"

- 15672-1** 190x38 mm
- 15672-2** 190x57 mm

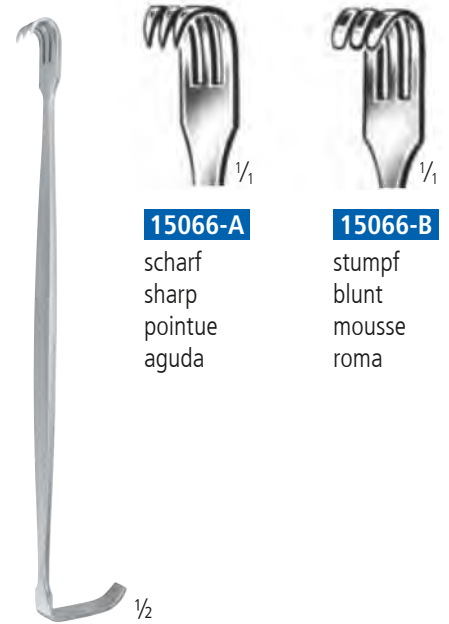

15066-A

scharf
sharp
pointue
aguda

15066-B

stumpf
blunt
mousse
roma

Baby-Senn-Miller
15,5 cm/6"



Ragnell-Davis
14,0 cm/5½"

15065-4

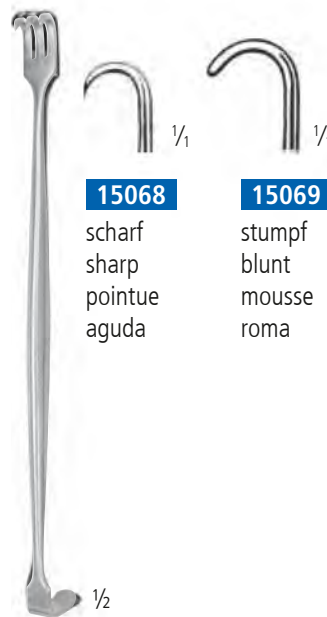

Senn-Miller
16,0 cm/6¼"



Senn-Green
15,0 cm/6"

**Wundhaken
Retractors
Ecarteurs
Separadores**



SCHWERT
SWORD · ESPADA
EPEE · SPADA

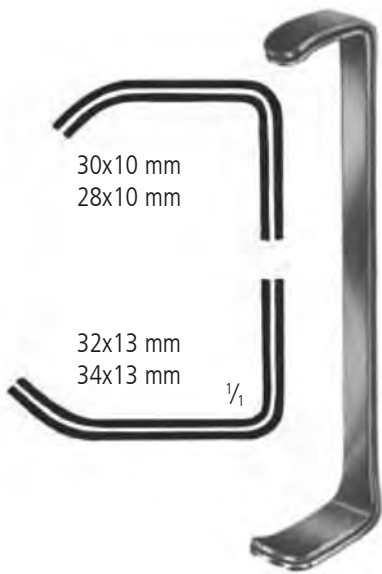

Farabeuf
12,0 cm/4¾"
15275-A
Satz, set
jeu, juego

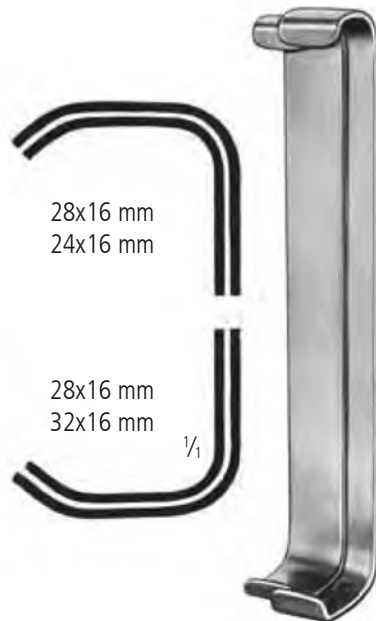

Farabeuf
15,0 cm/6"
15275-B
Satz, set
jeu, juego

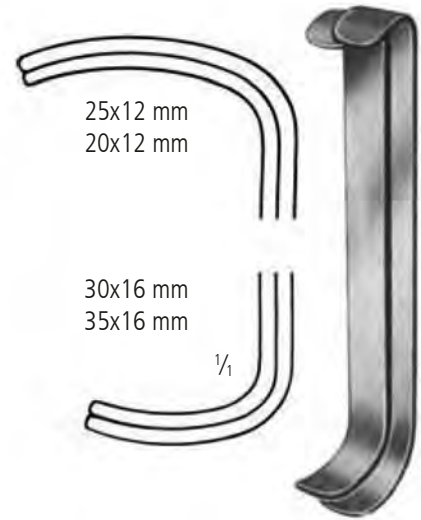

Collin
15,0 cm/6"
15270
Satz, set
jeu, juego

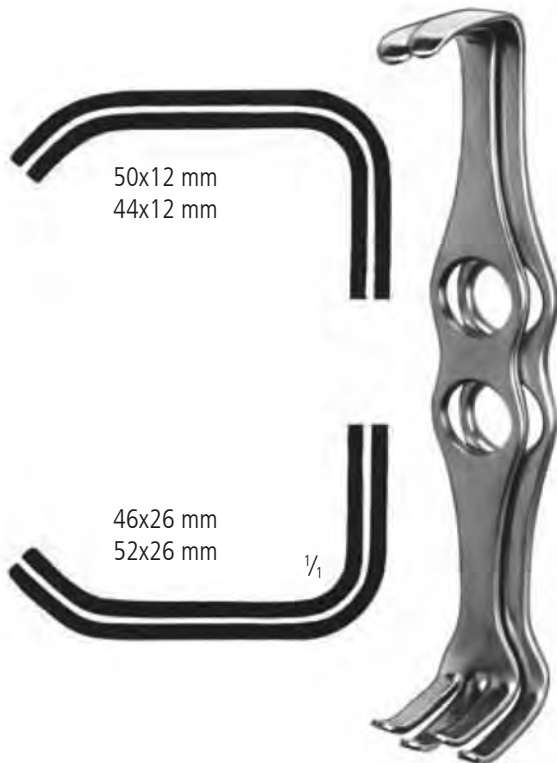

Mathieu
20,0 cm/8"
15284
Satz, set
jeu, juego

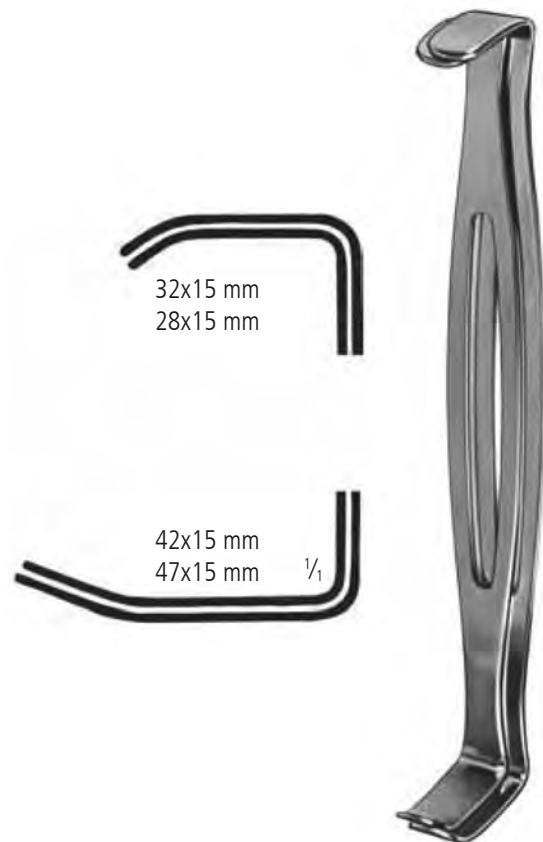

Parker-Langenbeck (US-Army)
21,0 cm/8¼"
15291
Satz, set
jeu, juego



SCHWERT
 SWORD · ESPADA
 EPEE · SPADA

**Wundhaken
 Retractors
 Ecarteurs
 Separadores**

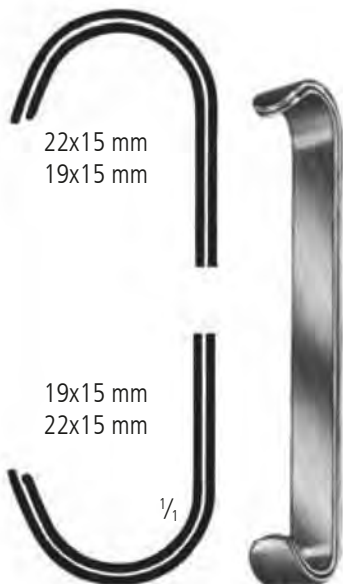

22x15 mm
 19x15 mm

19x15 mm
 22x15 mm

1/1

Parker
 13,5 cm/5 1/4"

15292-1

Satz, set
 jeu, juego

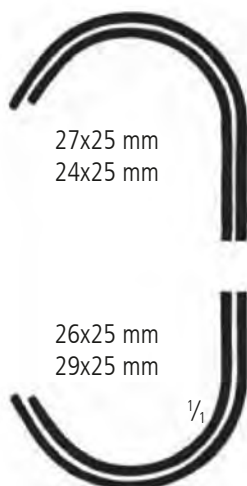

27x25 mm
 24x25 mm

26x25 mm
 29x25 mm

1/1

Parker
 18,0 cm/7"

15292-2

Satz, set
 jeu, juego



15x15 mm

18x21 mm

1/1

Baby-Roux
 13,0 cm/5 1/4"

15278



1/1

1/1

Mini-Roux
 15,0 cm/6"

15279

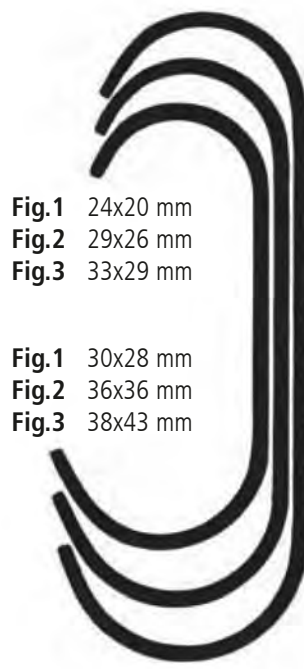

Fig.1 24x20 mm

Fig.2 29x26 mm

Fig.3 33x29 mm

Fig.1 30x28 mm

Fig.2 36x36 mm

Fig.3 38x43 mm

Roux
15277
 Satz, set
 jeu, juego

Roux
15277-1
15277-2
15277-3

Fig.1 14,0 cm/5 1/2"
Fig.3 15,0 cm/6"
Fig.4 17,0 cm/6 3/4"

**Wundspreizer
Retractors
Ecarteurs
Separadores**



SCHWERT
SWORD · ESPADA
EPEE · SPADA



15704-A50

scharf
sharp
pointue
aguda

Finsen
5,0 cm/5"



15704-50

stumpf
blunt
mousse
roma

Finsen
7,0 cm/2¾"

15704-A70

scharf
sharp
pointue
aguda

15704-70

stumpf
blunt
mousse
roma



20441

scharf
sharp
pointue
aguda

Jansen
10,0 cm/4"



20440

stumpf
blunt
mousse
roma

Jansen
10,0 cm/4"



15707-A

scharf
sharp
pointue
aguda

Holtzheimer
10,0 cm/4"

15707-B

stumpf
blunt
mousse
roma



SCHWERT
SWORD · ESPADA
EPEE · SPADA

**Wundspreizer
Retractors
Ecarteurs
Separadores**



Weitlaner-Loktite
10,5 cm/4 1/4"

15712-A10

scharf
sharp
pointue
aguda

15712-10

stumpf
blunt
mousse
roma



Weitlaner-Loktite

15712-A13

13,0 cm/5"

15712-A16

16,5 cm/6 1/2"

15712-A20

20,0 cm/8"

scharf
sharp
pointue
aguda

15712-13

15712-16

15712-20

stumpf
blunt
mousse
roma



Weitlaner-Wullstein
13,0 cm/5"

15714-A

scharf
sharp
pointue
aguda

15714

stumpf
blunt
mousse
roma



Weitlaner-Baby
13,0 cm/5"

15716



Scalp Contour
14,0 cm/5 1/2"

15717-A

scharf
sharp
pointue
aguda

15717-B

stumpf
blunt
mousse
roma

Wundspreizer
Retractors
Ecarteurs
Separadores



SCHWERT
SWORD · ESPADA
EPEE · SPADA



15719-B

stumpf
blunt
mousse
roma

Milligan
13,0 cm/5"



15720-A

scharf
sharp
pointue
aguda

Plester
13,0 cm/5"

15720-B

stumpf
blunt
mousse
roma



15721-1

stumpf
blunt
mousse
roma

Plester
11,0 cm/4¼"



15721-2

stumpf
blunt
mousse
roma

Plester
11,0 cm/4¼"



SCHWERT
SWORD - ESPADA
EPEE - SPADA

**Wundspreizer
Retractors
Ecarteurs
Separadores**

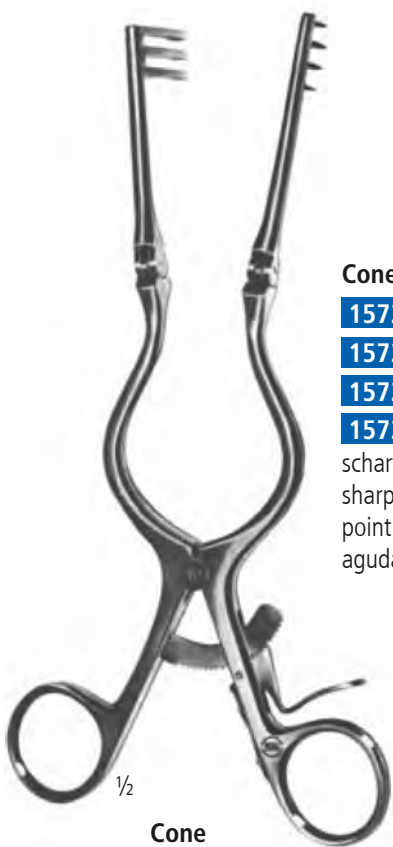

Cone

- 15722-A13** 13,0 cm/5"
- 15722-A16** 16,5 cm/6½"
- 15722-A20** 13,0 cm/5"
- 15722-A26** 16,5 cm/6½"

scharf
sharp
pointue
aguda

- 15722-13**
- 15722-16**
- 15722-20**
- 15722-26**

stumpf
blunt
mousse
roma



Tübinger Modell
16,5 cm/6½"

15710-16



Mollison
15,5 cm/6"

15709-15

scharf
sharp
pointue
aguda



Adson-Baby
16,0 cm/6¼"

15711-A16

scharf
sharp
pointue
aguda

15711-B16

stumpf
blunt
mousse
roma

**Wundspreizer
Retractors
Ecarteurs
Separadores**



SCHWERT
SWORD · ESPADA
EPEE · SPADA



15726-A

scharf
sharp
pointue
aguda

15726

stumpf
blunt
mousse
roma

Adson
32,0 cm/12½



15725-31

scharf
sharp
pointue
aguda

15725-B31

stumpf
blunt
mousse
roma

Beckmann
32,0 cm/12¼



18 mm

15740-A20

scharf
sharp
pointue
aguda

15740-B20

stumpf
blunt
mousse
roma

Adson
20,0 cm/8"



SCHWERT
SWORD · ESPADA
EPEE · SPADA

**Wundspreizer
Retractors
Ecarteurs
Separadores**

25 mm



Adson
26,5 cm/10½"

15740-A26

scharf
sharp
pointue
aguda

15740-B26

stumpf
blunt
mousse
roma

35 mm



Adson
26,5 cm/10½"

15741-A26

scharf
sharp
pointue
aguda

15741-B26

stumpf
blunt
mousse
roma

**Wundspreizer
Abdominal Retractors
Ecarteurs abdominaux
Separadores abdominales**



SCHWERT
SWORD · ESPADA
EPEE · SPADA



Rigby

15818

100 mm	70x16 mm
Spreizweite	Seitliche Valven
Spread	Lateral blades
Ecartement	Valves latérales
Apertura de la hoja	Valvas laterales



Markham-Meyerding

15728-1

83 mm	45x25 mm
18,0 cm/7"	Spreizweite
	Valve rechts
	Spread
	Blade right side
	Ecartement
	Valve à droite
	Apertura de la hoja
	Valva a la derecha



Markham-Meyerding

15728-2

83 mm	45x25 mm
18,0 cm/7"	Spreizweite
	Valve links
	Spread
	Blade left side
	Ecartement
	Valve à gauche
	Apertura de la hoja
	Valva a la izquierda



Meyerding

15728-11

15728-12

15728-13

15728-14

25x30 mm
25x55 mm
25x60 mm
20x60 mm
Seitliche Valven
Lateral blades
Valves latérales
Valvas laterales

19,0 cm/7½"





SCHWERT
SWORD · ESPADA
EPEE · SPADA

**Wundspreizer
Abdominal Retractors
Ecarteurs abdominaux
Separadores abdominales**



Gelpi-Loktite

15718-9 9,0 cm/3½"

15718-11 11,5 cm/4½"



Gelpi-Loktite

15718-13 14,0 cm/5½"

15718 18,0 cm/7"

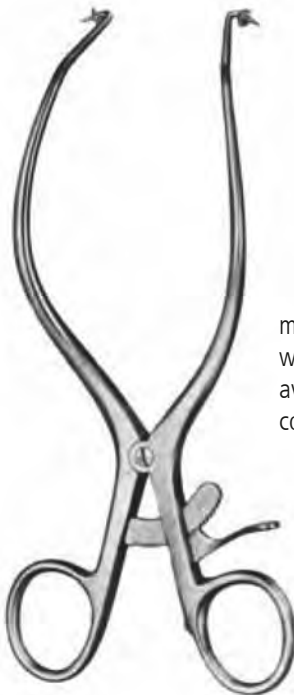

mit Kugel
with bals
avec boules
con bolas

Gelpi-Loktite

15760 18,0 cm/7"



DeBakey

15761-10 100 mm

15761-14 145 mm

**Wundsperrer
Retractors
Ecarteurs
Separadores**



SCHWERT
SWORD · ESPADA
EPEE · SPADA



1/2

Beckmann-Eaton
32,0 cm/12 3/4"

15729-32

scharf
sharp
pointue
aguda



1/2

Beckmann-Adson
31,0 cm/12 1/4"

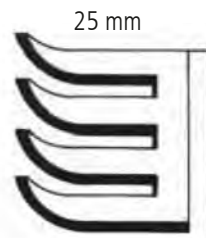

25 mm

15727-1B

stumpf
blunt
mousse
roma

15727-1A

scharf
sharp
pointue
aguda

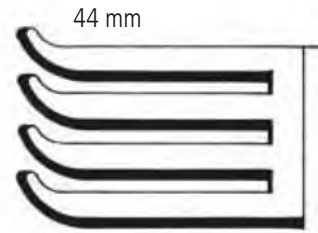

44 mm

15727-4B

stumpf
blunt
mousse
roma

15727-4A

scharf
sharp
pointue
aguda



1/2

Anderson-Adson
19,5 cm/8"

15715-A20

scharf	gewinkelte Arme
sharp	angular
pointue	anglé
aguda	angulado



SCHWERT
SWORD - ESPADA
EPEE - SPADA

Bauchdeckenhalter
Abdominal Retractors
Ecarteurs abdominaux
Separadores abdominales



Ricard

15745-28	280 mm	75x85 mm	80x90 mm
15745-30	300 mm	60x80 mm	55x70 mm
	Spreizweite	Seitliche Valven	Mittelvalve
	Spread	Lateral blades	Center blade
	Ecartement	Valves latérales	Valve centrale
	Apertura de la hoja	Valvas laterales	Valve central



Holzbach

15746	62x80 mm	80x00 mm
	Seitliche Valven	Mittelvalve
	Lateral blades	Center blade
	Valves latérales	Valve centrale
	Valvas laterales	Valve central



Collin-Loktite

26,0 cm/10½"

15747-16	160 mm	60x80 mm	60x75 mm
	Spreizweite	Seitliche Valven	Mittelvalve
	Spread	Lateral blades	Center blade
	Ecartement	Valves latérales	Valve centrale
	Apertura de la hoja	Valvas laterales	Valve central

**Bauchdeckenhalter
Abdominal Retractors
Ecarteurs abdominaux
Separadores abdominales**



SCHWERT
SWORD · ESPADA
EPEE · SPADA



komplett mit 2 Paar Valven
complete, with 2 pairs of blades
complet, avec 2 paires de valves
completo, con 2 pares de valvas

Baby-Collin

15747-8	80 mm	27x40 mm
	Spreizweite	18x40 mm
	Spread	Seitliche Valven
	Ecartement	Lateral blades
	Apertura de la hoja	Valves latérales
		Valvas latérales



Collin

15752	100 mm	38x60 mm
	Spreizweite	Seitliche Valven
	Spread	Lateral blades
	Ecartement	Valves latérales
	Apertura de la hoja	Valvas latérales



Collin-Loktite

15753	100 mm	38x60 mm	38x55 mm
15753-2	100 mm	38x80 mm	50x75 mm
	Spreizweite	Seitliche Valven	Mittelvalve
	Spread	Lateral blades	Center blade
	Ecartement	Valves latérales	Valve centrale
	Apertura de la hoja	Valvas latérales	Valve central



**Wechselvalven
Exchangeable blades
Valves interchangeables
Valvas intercambiables**

15755-18	18x40 mm
15755-27	27x40 mm
15755-38	38x60 mm
15755-40	40x80 mm



SCHWERT
 SWORD · ESPADA
 EPEE · SPADA

**Bauchdeckenhalter
 Abdominal Retractors
 Ecarteurs abdominaux
 Separadores abdominales**



Gosset

15765-1

100 mm	30x40 mm
Spreizweite	Seitliche Valven
Spread	Lateral blades
Ecartement	Valves latérales
Apertura de la hoja	Valvas laterales



Gosset

15770-1

100 mm	30x40 mm
Spreizweite	Seitliche Valven
Spread	Lateral blades
Ecartement	Valves latérales
Apertura de la hoja	Valvas laterales



Gosset

15770-3

140 mm	35x63 mm
Spreizweite	Seitliche Valven
Spread	Lateral blades
Ecartement	Valves latérales
Apertura de la hoja	Valvas laterales



Gosset

15771

160 mm	35x63 mm	56x60 mm
Spreizweite	Seitliche Valven	Mittelvalve
Spread	Lateral blades	Center blade
Ecartement	Valves latérales	Valve centrale
Apertura de la hoja	Valvas laterales	Valve central

Bauchdeckenhalter
Abdominal Retractors
Ecarteurs abdominaux
Separadores abdominales



SCHWERT
 SWORD · ESPADA
 EPEE · SPADA



Balfour-Baby

15779	90 mm	26x38 mm	25x23 mm
	Spreizweite	Seitliche Valven	Mittelvalve
	Spread	Lateral blades	Center blade
	Ecartement	Valves latérales	Valve centrale
	Apertura de la hoja	Valvas latérales	Valve central



Balfour

15781	180 mm	35x70 mm	45x80 mm
	Spreizweite	Seitliche Valven	Mittelvalve
	Spread	Lateral blades	Center blade
	Ecartement	Valves latérales	Valve centrale
	Apertura de la hoja	Valvas latérales	Valve central



Balfour

15783	200 mm	35x100 mm	60x100 mm
	Spreizweite	Seitliche Valven	Mittelvalve
	Spread	Lateral blades	Center blade
	Ecartement	Valves latérales	Valve centrale
	Apertura de la hoja	Valvas latérales	Valve central



SCHWERT
SWORD - ESPADA
EPEE - SPADA

**Bauchdeckenhalter
Abdominal Retractors
Ecarteurs abdominaux
Separadores abdominales**



Balfour

15785

250 mm	35x100 mm	70x85 mm
Spreizweite	Seitliche Valven	Mittelvalve
Spread	Lateral blades	Center blade
Ecartement	Valves latérales	Valve centrale
Apertura de la hoja	Valvas laterales	Valve central



Balfour

15782

180 mm	35x700 mm	45x80 mm
Spreizweite	Seitliche Valven	Mittelvalve
Spread	Lateral blades	Center blade
Ecartement	Valves latérales	Valve centrale
Apertura de la hoja	Valvas laterales	Valve central



Mittelvalve allein
Center blade only
Valve centrale seule
Valta central suelta

Balfour

15781-11

45x80 mm

15785-11

70x85 mm

15783-11

100x60 mm



Bauchdeckenhalter
Abdominal Retractors
Ecarteurs abdominaux
Separadores abdominales



SCHWERT
 SWORD · ESPADA
 EPEE · SPADA

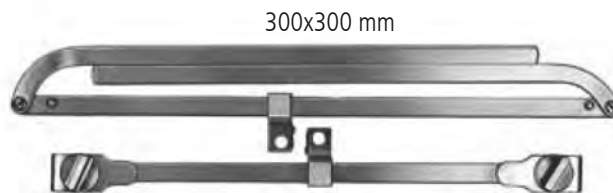
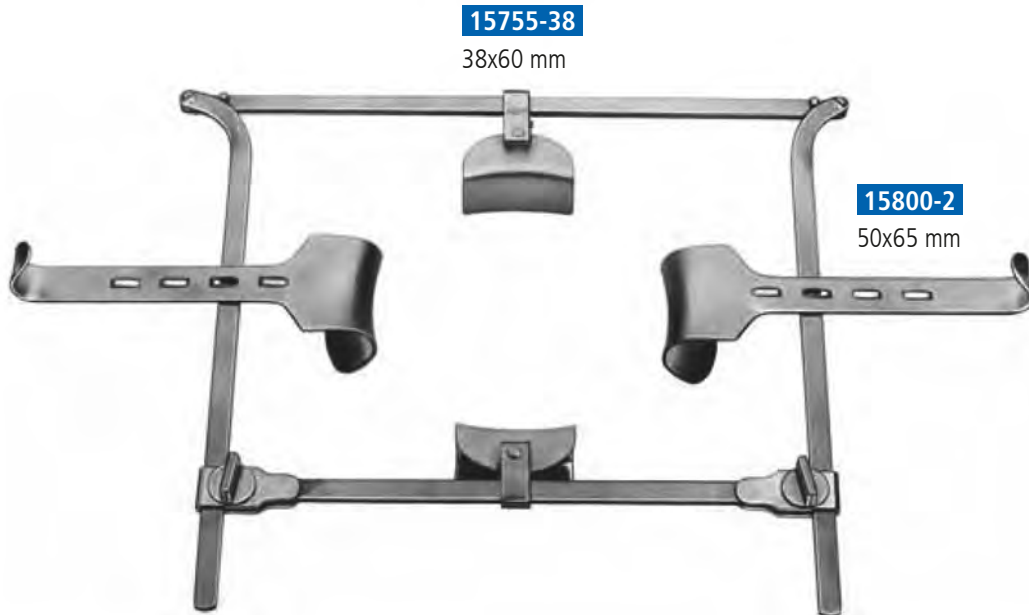

Franz			Tiefe	Breite
			Depth	Width
			Profondeur	Largueur
			Profundidad	Anchura
15805	mit 4 Valven	2x	50 mm	x 65 mm
	with 4 valves	2x	38 mm	x 60 mm
15805-8	mit 8 Valven	2x	50 mm	x 65 mm
	with 8 valves	2x	38 mm	x 60 mm
	avec 8 valves	2x	60 mm	x 85 mm
	con 8 valvas	2x	45 mm	x 80 mm

15805-R
 Rahmen zusammenlegbar
 Folding frame
 Cadre pliant
 Cuadro plegable



SCHWERT
SWORD · ESPADA
EPEE · SPADA

Bauchdeckenhalter
Abdominal Retractors
Ecarteurs abdominaux
Separadores abdominales

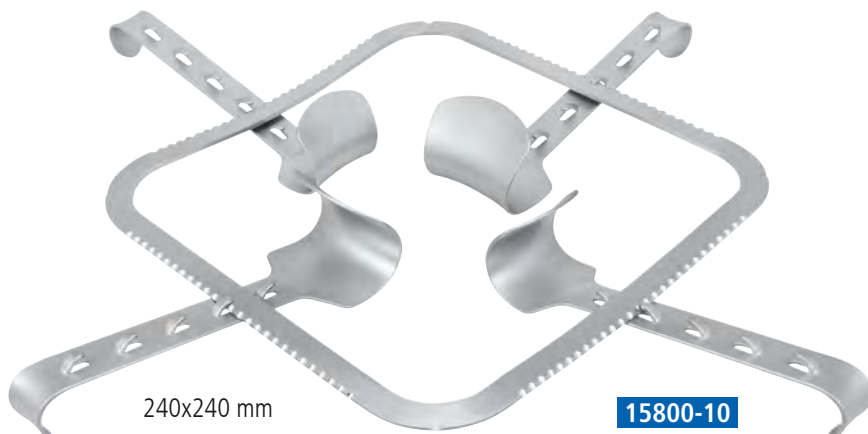

240x240 mm

Rahmen starr
Fixed frame
Cadre fixe
Cuadro fijo

15800-10

Rahmen allein
Frame only
Cadre seul
Cuadro suelto



Kirschner

- 15800-1** 40x55 mm
- 15800-2** 50x65 mm
- 15800-3** 60x85 mm
- 15800-4** 78x65 mm
- 15800-5** 80x90 mm



Kirschner

- 15800-6** 98x50 mm
- 15800-7** 105x35 mm

		Tiefe		Breite	
		Depth		Width	
Kirschner		Profondeur	Largueur	Anchura	
15800	mit 4 Valven	2x 40 mm	x 55 mm		
	with 4 valves	2x 50 mm	x 65 mm		
	avec 4 valves				
	con 4 valvas				



175x150 mm

15823-10

Rahmen allein
Frame only
Cadre seul
Cuadro suelto

Valven allein
Valves only
Valves seules
Valvas sueltas

		Tiefe		Breite	
		Depth		Width	
Denis-Browner		Profondeur	Largueur	Anchura	
15823	mit 4 Valven	2x 40 mm	x 30 mm		
	with 4 valves	2x 40 mm	x 40 mm		
	avec 4 valves				
	con 4 valvas				

- 15823-1** 20x30 mm
- 15823-2** 20x40 mm
- 15823-3** 40x30 mm
- 15823-4** 40x40 mm



Bauchdeckenhalter
Abdominal Retractors
Ecarteurs abdominaux
Separadores abdominales



SCHWERT
 SWORD · ESPADA
 EPEE · SPADA



15815-10

Rahmen allein
 Frame only
 Cadre seul
 Cuadro suelto

O'Sullivan-O'Connor

15815

mit 3 Valven 2x
 with 3 valves 2x
 avec 3 valves
 con 3 valvas

Tiefe	Breite
Depth	Width
Profondeur	Largueur
Profundidad	Anchura

80 mm	x 45 mm
110 mm	x 70 mm



Valve allein
 Valve only
 Valve seules
 Valva sueltas

15815-1

80x45 mm



Valve allein
 Valve only
 Valve seules
 Valva sueltas

15815-2

110x70 mm



SCHWERT
SWORD - ESPADA
EPEE - SPADA

Bauchdeckenhalter
Abdominal Retractors
Ecarteurs abdominaux
Separadores abdominales



Temple-Fay

15773

120 mm
Spreizweite
Spread
Ecartement
Apertura de la hoja

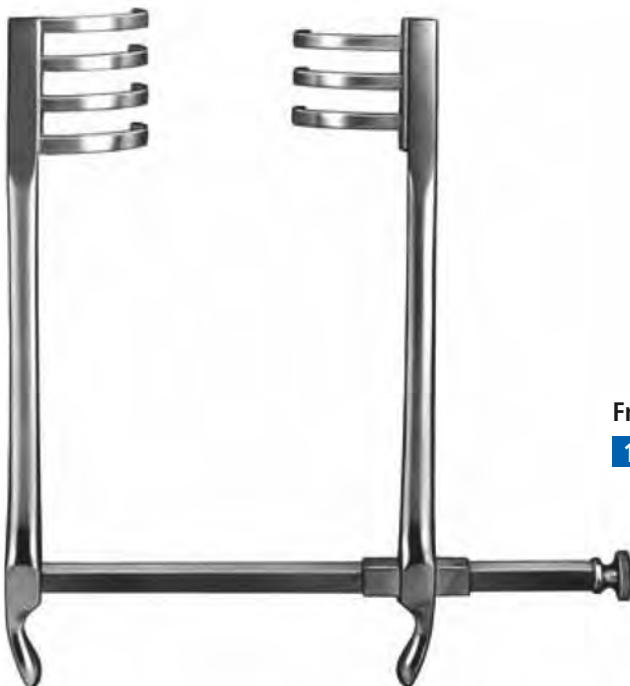

Frazier

15774

85 mm
Spreizweite
Spread
Ecartement
Apertura de la hoja

Bauch- und Darmspatel
Abdominal and Intestinal Spatulas
Spatules abdominales et intestinales
Espátulas abdominales y intestinales



SCHWERT
 SWORD · ESPADA
 EPEE · SPADA

biegsam, flexible, maleable, flexible



24405-30

33,0 cm/13"
 30 mm

24405-40

33,0 cm/13"
 40 mm

24405-50

33,0 cm/13"
 50 mm

biegsam, flexible, maleable, flexible



Haberer

24409-28

28,0 cm/11"
 25x30 mm

24409-30

30,0 cm/12"
 37x45 mm



Reverdin

24414

28,5 cm/11¼"
 65x45 mm

biegsam, flexible, maleable, flexible



24407-6

20,0 cm/8"
 6 mm

24407-9

20,0 cm/8"
 9 mm

24407-12

20,0 cm/8"
 12 mm

24407-17

20,0 cm/8"
 17 mm

24407-20

20,0 cm/8"
 20 mm

24407-25

20,0 cm/8"
 25 mm

biegsam, flexible, maleable, flexible



Tuffier

24417

20,0 cm/8"
 17x25 mm



SCHWERT
SWORD · ESPADA
EPEE · SPADA

Bauch- und Darmspatel
Abdominal and Intestinal Spatulas
Spatules abdominales et intestinales
Espátulas abdominales y intestinales



46 mm

biegsam
flexible
maleable
flexible

Kuemmel
33,0 cm/13"

24420 46 mm



Kader
27,0 cm/10³/₄"

24421-20 20 mm

24421-30 30 mm

24421-40 40 mm



biegsam
flexible
maleable
flexible

41,0 cm/16"

24425-30 30 mm

24425-40 40 mm

24425-50 50 mm

24425-60 60 mm

24425-70 70 mm



SCHWERT
SWORD · ESPADA
EPEE · SPADA

Thorax- und Gefäß-Chirurgie

Thoracic and Vascular Surgery

Chirurgie Thoracique et Vasculaire

Cirugía Torácica y Vascular





Knochen- und Rippenscheren
Bone and Rib Shears
Costotomes, Cisailles pour os
Cizallas para huesos y costillas

SCHWERT
SWORD · ESPADA
EPEE · SPADA

mit ziehendem Schnitt
with eccentric sliding blade
avec lame glissante
con hoja de retroacción



16430
22,5 cm/9"

Rippenschere
Rib Shears
Costotomes
Cizallas para costillas



16432-23
22,5 cm/9"

Knochenschere
Bone Shears
Cisailles pour os
Cizallas para huesos



Gluck
21,0 cm/8³/₄"
16434-22

Rippenschere
Rib Shears
Costotomes
Cizallas para costillas

Rippenscheren
Rib Shears
Costotomes
Cizallas para costillas



SCHWERT
SWORD · ESPADA
EPEE · SPADA

Griffe mit Gummiüberzug
Handles with rubber cover
Manches avec couverture en caoutchouc
Mangos con cubierta de goma



Bethune
34,0 cm/13½"

16470-1



Giertz-Stille
27,0 cm/10½"

16484-25



Brunner
32,0 cm/12½"

16479-1

für die rechte Hand
for the right hand
pour la main droite
para la mano derecha



SCHWERT
SWORD · ESPADA
EPEE · SPADA

Knochen- und Rippenscheren Bone and Rib Shears Costotomes, Cisailles pour os Cizallas para huesos y costillas

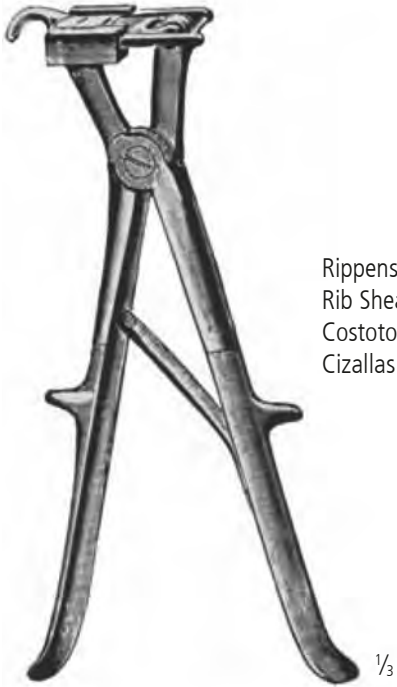

Rippenschere
Rib Shears
Costotomes
Cizallas para costillas

Sauerbruch
26,0 cm/10¼"

16457-26



Rippenschere
Rib Shears
Costotomes
Cizallas para costillas

Sauerbruch-Frey
36,0 cm/14"

16480



Sternumschere
Sternum scissors
Cisailles à sternum
Tijeras de esternón

Lebsche
25,0 cm/10"

16490

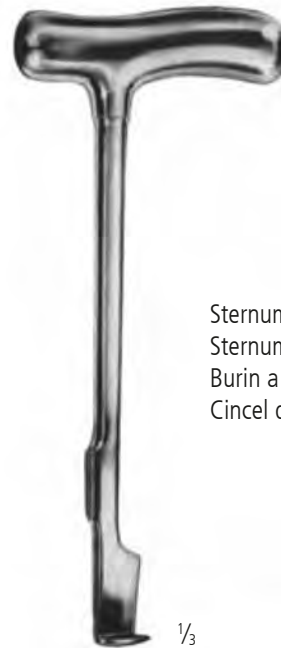

Sternummeißel
Sternum chisel
Burin a Sternum
Cinzel de esternón

Lebsche
24,5 cm/9¾"

16498

Rippensperrer aus Aluminium
 Rib Spreaders from Aluminium
 Ecarteurs des côtes en aluminium
 Separadores costales de aluminio



SCHWERT
 SWORD · ESPADA
 EPEE · SPADA



Aluminium
 Aluminio

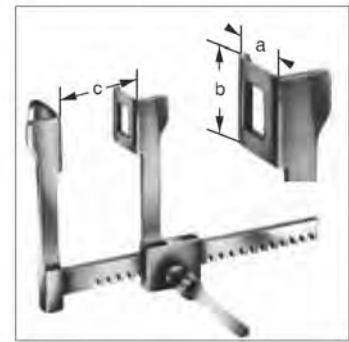

Finocchietto-Infant

	a	b	c
16560	10 mm	15 mm	70 mm



Aluminium
 Aluminio

Finocchietto-Baby-Haight

	a	b	c
16561	31 mm	31 mm	80 mm



Aluminium
 Aluminio

Finocchietto

	a	b	c
16562-1	30 mm	45 mm	140 mm
16562-2	40 mm	62 mm	175 mm
16562-3	64 mm	65 mm	175 mm



SCHWERT
SWORD · ESPADA
EPEE · SPADA

Rippensperrer aus Aluminium
Rib Spreaders from Aluminium
Ecarteurs des côtes en aluminium
Separadores costales de aluminio

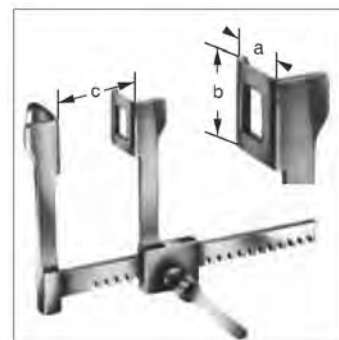

Aluminium
Aluminio

Burford	für Kinder for children pour enfants para niños	mit 2 Paar Valven with 2 pairs of blades avec 2 paires de valves con 2 pares de valvas	
	a	b	c
16563	41 mm 30 mm	42 mm 42 mm	130 mm



Aluminium
Aluminio

Burford	für Erwachsene for adults pour adultes para adultes	mit 2 Paar Valven with 2 pairs of blades avec 2 paires de valves con 2 pares de valvas	
	a	b	c
16564-1	65 mm 47 mm	62 mm 62 mm	165 mm
16564-2	65 mm 47 mm	62 mm 62 mm	250 mm
16564-3	65 mm 47 mm	62 mm 62 mm	290 mm

Rippensperrer aus Aluminium
Rib Spreaders from Aluminium
Ecarteurs des côtes en aluminium
Separadores costales de aluminio



SCHWERT
 SWORD · ESPADA
 EPEE · SPADA

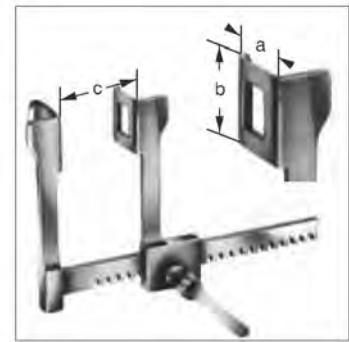

Aluminium
 Aluminio

für Säuglinge
 for newborns
 pour bébés
 para recién nacidos

Cooley

	a	b	c
16565-1	12 mm	16 mm	70 mm



Aluminium
 Aluminio

für Kinder
 for children
 pour enfants
 para niños

Cooley

	a	b	c
16565-2	15 mm	30 mm	100 mm



Aluminium
 Aluminio

für Erwachsene
 for adults
 pour adultes
 para adultos

Cooley

	a	b	c
16565-3	21 mm	44 mm	140 mm
16565-4	30 mm	50 mm	185 mm



SCHWERT
SWORD · ESPADA
EPEE · SPADA

Rippensperrer aus Aluminium
Rib Spreaders from Aluminium
Ecarteurs des côtes en aluminium
Separadores costales de aluminio

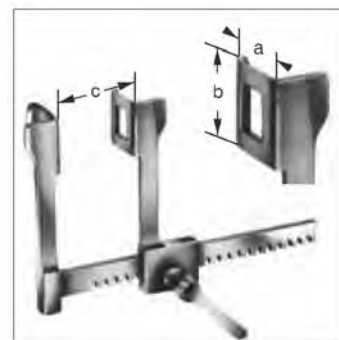

Aluminium
Aluminio

für Säuglinge
for newborns
pour bébés
para recién nacidos

Castañeda	a	b	c
16566-1	10,5 mm	32 mm	65 mm

für Kinder
for children
pour enfants
para niños

Castañeda	a	b	c
16566-2	12 mm	45 mm	70 mm
16566-3	15 mm	60 mm	100 mm

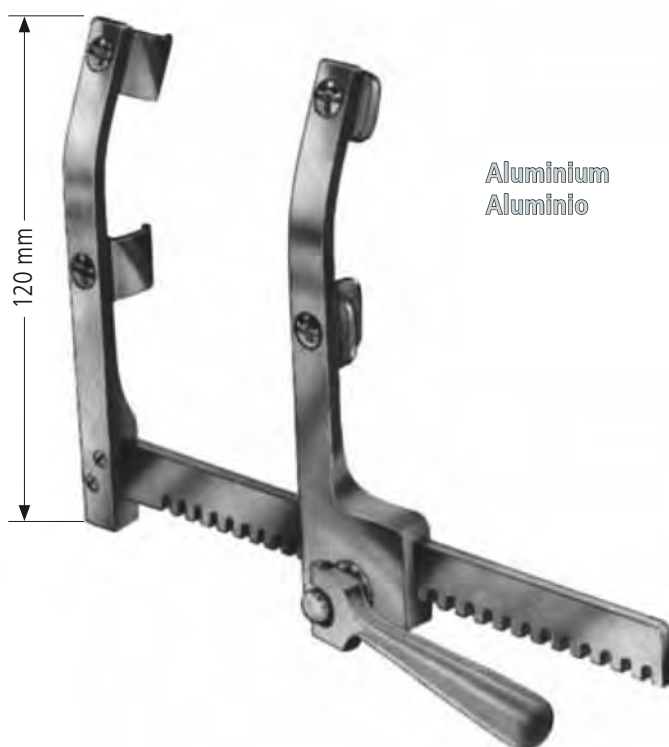

Aluminium
Aluminio

Morse	a	b	c
16567	20 mm	20 mm	165 mm

Rippensperrer
Rib Spreaders
Ecarteurs des côtes
Separadores costales



SCHWERT
SWORD · ESPADA
EPEE · SPADA

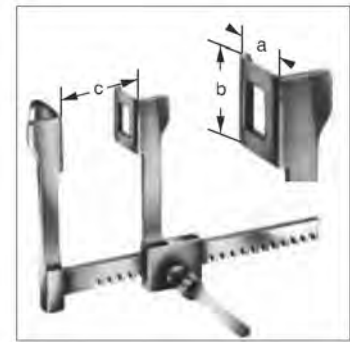

Finocchietto-Baby

	a	b	c
16584	19 mm	20 mm	75 mm



Finocchietto

	a	b	c
16590-1	40 mm	40 mm	165 mm
16590-2	45 mm	65 mm	200 mm
16590-3	65 mm	65 mm	250 mm



Rippensperrer
Rib Spreaders
Ecarteurs des côtes
Separadores costales

SCHWERT
 SWORD - ESPADA
 EPEE - SPADA

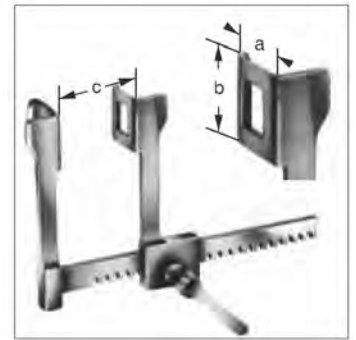
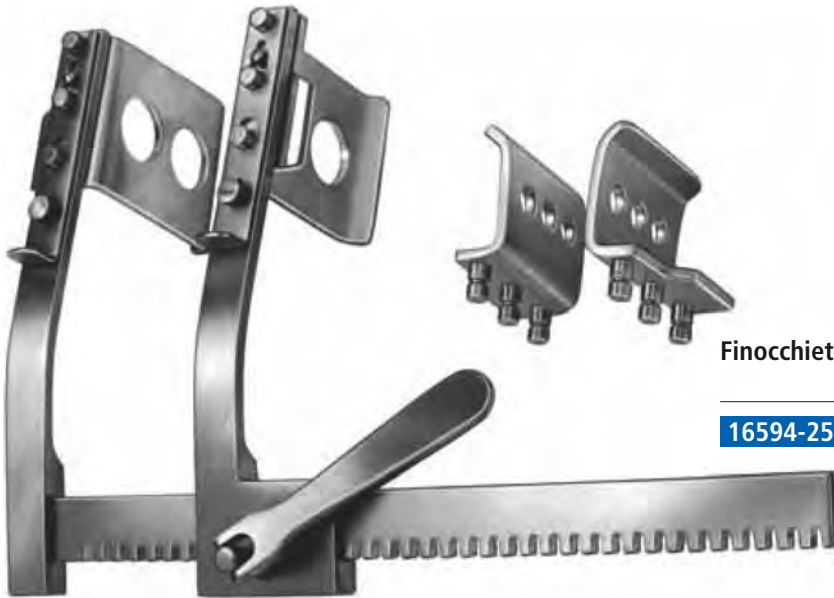

Finocchietto-Burford

	a	b	c
16594-25	80 mm 40 mm	67 mm 67 mm	250 mm

mit 2 Paar Valven
 with 2 pairs of blades
 avec 2 paires de valves
 con 2 pares de valvas



Tuffier

	a	b	c
16574-16	50 mm	45 mm	165 mm

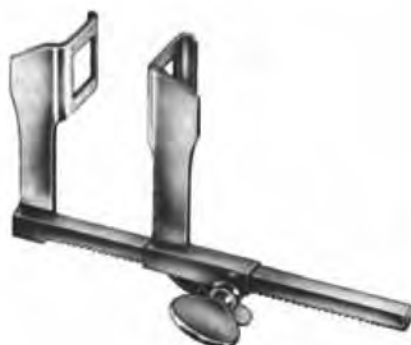

Haight

	a	b	c
16586	30 mm	30 mm	90 mm

Rippensperrer
 Rib Spreaders
 Ecarteurs des côtes
 Separadores costales



SCHWERT
 SWORD · ESPADA
 EPEE · SPADA

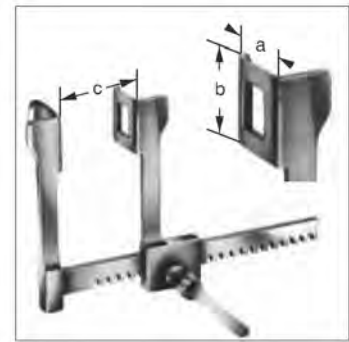

Cooley	für Kinder for children pour enfants para niños		
	a	b	c
16576-1	21 mm	45 mm	145 mm



Cooley	für Erwachsene for adults pour adultes para adultos		
	a	b	c
16576-2	32 mm	50 mm	190 mm



SCHWERT
SWORD - ESPADA
EPEE - SPADA

Rippensperrer
Rib Spreaders
Ecarteurs des côtes
Separadores costales

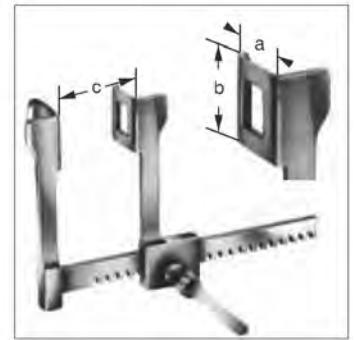

Morse

für Kinder
for children
pour enfants
para niños

	a	b	c
16577-1	12 mm	20 mm	200 mm

Morse

für Erwachsene
for adults
pour adultes
para adultos

	a	b	c
16577-2	19 mm	19 mm	200 mm



Morse-Favaloro

	a	b	c
16578	38 mm	28 mm	200 mm

Rippensperrer
 Rib Spreaders
 Ecarteurs des côtes
 Separadores costales



SCHWERT
 SWORD · ESPADA
 EPEE · SPADA

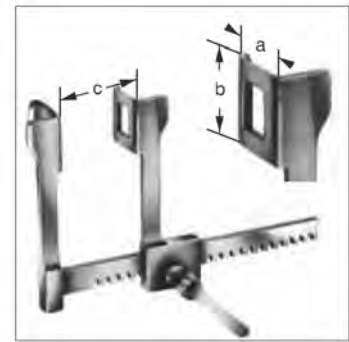

mit 1 Paar zusätzlich abnehmbaren Valven
 with 1 pair of additional detachable blades
 avec 1 paire de valves démontables, supplémentaire
 con 1 par de valvas desmontables, adicional

a	b
40 mm	50 mm

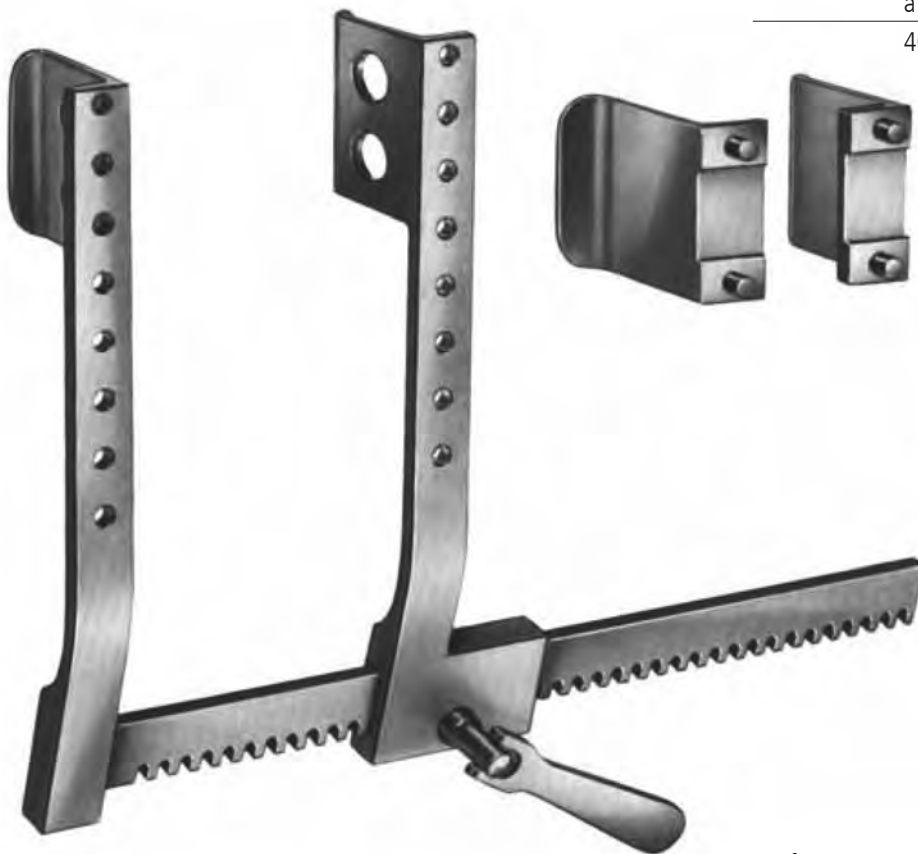

Harken

	a	b	c
16579	45 mm	65 mm	250 mm



SCHWERT
SWORD - ESPADA
EPEE - SPADA

Rippenkontraktoren
Rib Contractors
Rapprocheurs costaux
Aproximadores para costillas

Lungenspatel
Lung Spatulas
Spatules pulmonaires
Espátulas pulmonares



Bailey-Gibbon

16553

16,0 cm/6¼"



Bailey

16550

16,0 cm/6¼"



Bailey-Baby

16549

14,0 cm/5½"



Lungenspatel
Lung Spatulas
Spatules pulmonaires
Espátulas pulmonares

Allison

15445

40 mm
27,0 cm/11"

Lungenfazzangen
 Lung Grasping Forceps
 Pincés-clamps à poumons
 Pinzas-clamps pulmonares



SCHWERT
 SWORD · ESPADA
 EPEE · SPADA



25 mm/1"



gerade
 straight
 droits
 rectas

Lovelace

16825

20,0 cm/8"

16826

20,0 cm/8"

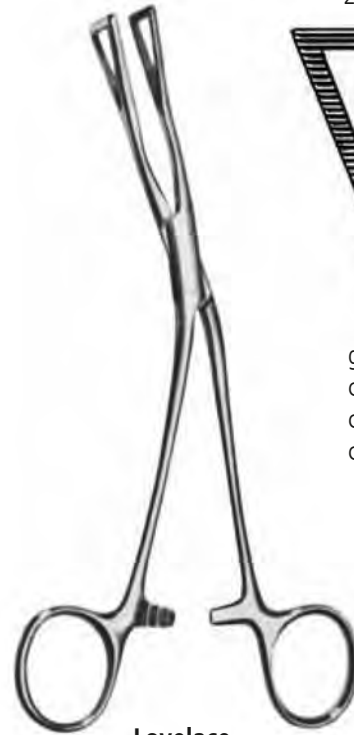

25 mm/1"

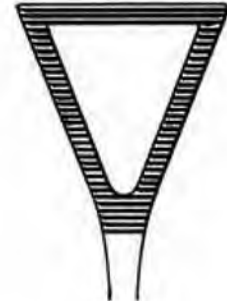

gebogen
 curved
 courbes
 curvas

Lovelace

16837-3

20,0 cm/8"



13 mm/1/2"



16830-1

20,0 cm/8"

25 mm/1"

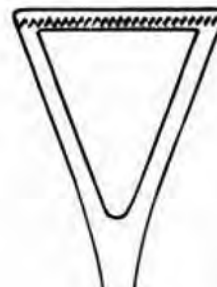

16830-3

20,0 cm/8"

16829-3

23,0 cm/9 1/4"

Duval



Gefäßklemmen
Blood Vessel Clamps
Pinces vasculaires
Clamps para vasos

SCHWERT
SWORD - ESPADA
EPEE - SPADA



Satinsky
26,5 cm/10½"

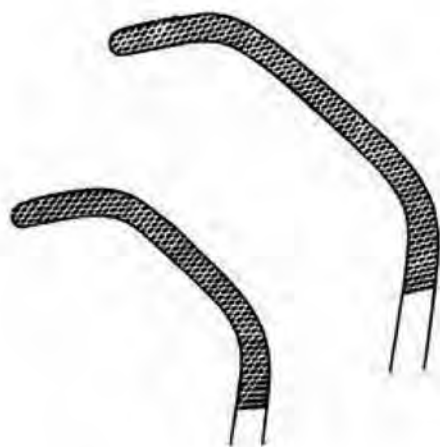

Fig. 1
17447-1

Fig. 2
17447-2



Satinsky
26,5 cm/10½"

s-förmig
s-shaped
forme en S
en forma de S

Fig. 1
17449-1

Fig. 2
17449-2

Gefäßklemmen
Blood Vessel Clamps
Pinces vasculaires
Clamps para vasos



Gefäßklemmen
 Blood Vessel Clamps
 Pinces vasculaires
 Clamps para vasos

Baby-Satinsky

17450-15

15,0 cm/6"

Gefäßdilatoren
Vascular Dilators
Dilatateurs vasculaires
Dilatadores vasculares

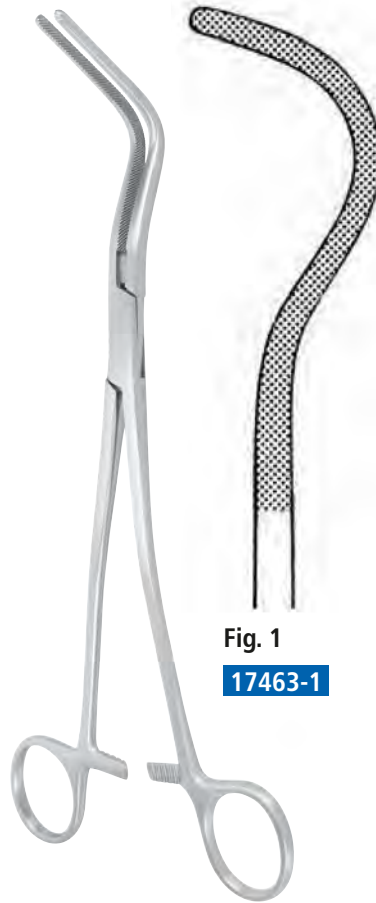

Fig. 1

17463-1



Fig. 2

17463-2



Fig. 3

17463-3

Harken

24,0 cm/9½"

Gefäßdilatoren
 Vascular Dilators
 Dilatateurs vasculaires
 Dilatadores vasculares

biegsam
 malleable maleable
 flexible



19,0 cm/7½"



17104-05

0,5 mm Ø



17104-10

1,0 mm Ø



17104-15

1,5 mm Ø



17104-20

2,0 mm Ø



17104-25

2,5 mm Ø



17104-30

3,0 mm Ø



17104-35

3,5 mm Ø



17104-40

4,0 mm Ø



17104-45

4,5 mm Ø



17104-50

5,0 mm Ø



17104-70

7,0 mm Ø



17104-90

9,0 mm Ø



SCHWERT
 SWORD · ESPADA
 EPEE · SPADA





SCHWERT
SWORD · ESPADA
EPEE · SPADA

Kopf und Wirbelsäule

Head and Spine

Tête et Colonne Vertébrale

Cabeza y Columna Vertebral

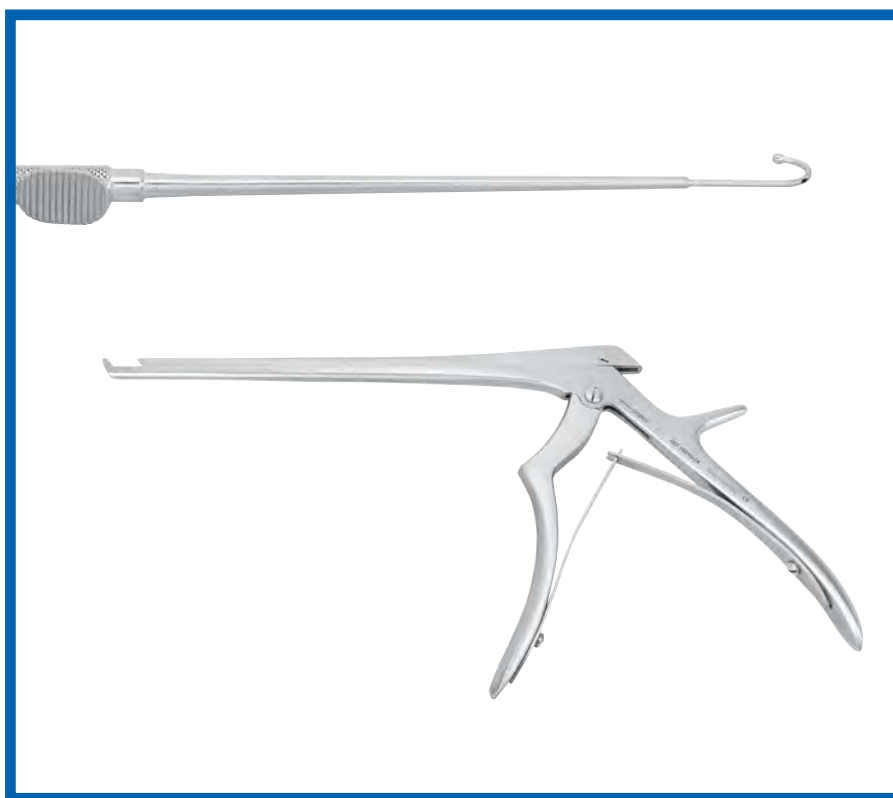

Instrumente zur Schädelöffnung
Instruments for Cranial Opening
Instrumentes pour l'ouverture du crâne
Instrumentes para abertura craneana



SCHWERT
 SWORD · ESPADA
 EPEE · SPADA

Drahtsäge
 Wire Saw
 Scie en fil
 Sierra de hilo



Olivecrona

2-fach, two-fold
 à deux pièces, de dos piezas
1,2 mm Ø

- 13260-30 Fig. 1** 30 cm/12"
- 13260-40 Fig. 2** 40 cm/16"
- 13260-50 Fig. 3** 50 cm/20"
- 13260-60 Fig. 4** 60 cm/24"
- 13260-70 Fig. 5** 70 cm/28"

Gigli

3-fach, three-fold
 à trois pièces, de tres piezas
1,4 mm Ø

- 13265-30 Fig. 1** 30 cm/12"
- 13265-40 Fig. 2** 40 cm/16"
- 13265-50 Fig. 3** 50 cm/20"
- 1,8 mm Ø**
- 13266-50 Fig. 1** 50 cm/20"



Gigli

13271

Sägegriff
 Saw Handle
 Manche pour scies
 Mango para sierras

Martel

Einführungsinstrument für Drahtsägen
 Conductor for wire saws
 Conducteur pour scies en fil
 Conductores para sierras de hilo

- 13284-30** 30 cm/12"
- 13284** 33,0 cm/13¼"



Schädelzangen
 Scull-Cutting Forceps
 Pincas pour le crâne
 Pinzas para el cráneo

Dahlgren

18173

20,0 cm/8"



De Vilbiss

18178

21,0 cm/8¼"





SCHWERT
SWORD · ESPADA
EPEE · SPADA

Schädelhalter
Cervical Traction Tongs
Pinces de traction crânienne
Pinzas de tracción craneal



18114

Schädelhalter für die Extension des Halswirbels, Dorne verstellbar, Vorbohren nicht erforderlich

Cervical Traction Tong, for extension of the neck vertebrae, pins adjustable hence no initial drilling

Pince de traction crânienne, pour l'extension des vertèbres cervicales, madrins réglables supprimant la perforation initiale

Pinza de tracción craneal para la extensión de las vértebras de cuello, puntas ajustables suprimiendo perforaciones iniciales



Crutchfield

18116 Fig. 1

Schädelhalter
Cervical Traction Tong
Pince de traction crânienne
Pinza de tracción craneal



Crutchfield

18117 Fig. 2

Schädelhalter
Cervical Traction Tong
Pince de traction crânienne
Pinza de tracción craneal

Wirbelkörperspreizer
 Lamina Spreaders
 Ecarteurs pour corps vertébraux
 Separadores para cuerpos vertebrales



SCHWERT
 SWORD · ESPADA
 EPEE · SPADA



Cloward

18231-16

16,0 cm/6 1/2"



Inge

18232-16

16,0 cm/6 1/2"

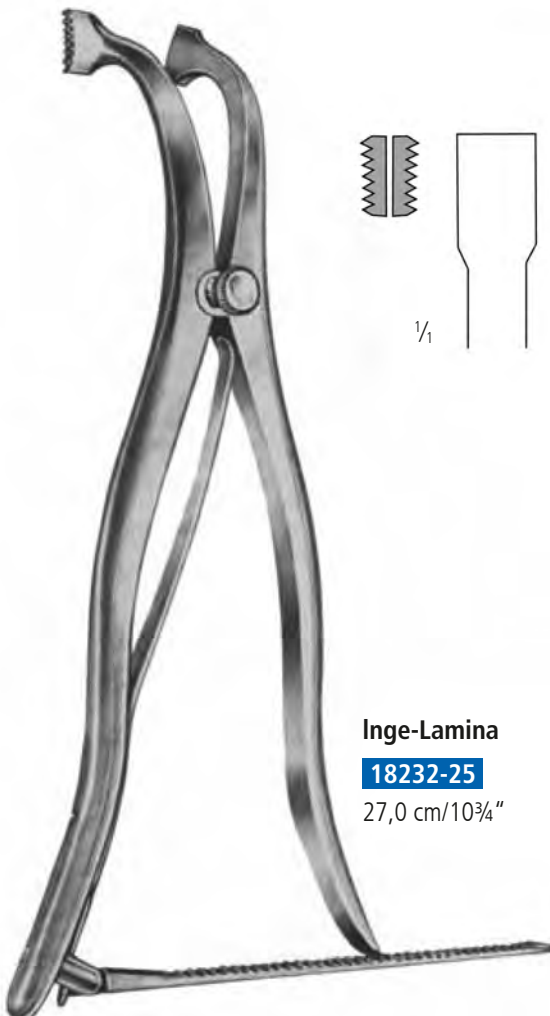

Inge-Lamina

18232-25

27,0 cm/10 3/4"



Raney

18558 16,0 cm/6 1/2"

Anlege- und Abnehmezange für Kopfhautklammern
 Applying and Removing Forceps for Scalp Hemostasis Clips
 Pince pour appliquer et enlever les clips hemostatiques pour
 le cuir chevelu
 Pinza para aplicar y quitar clips hemostáticas para el cuero
 cabelludo



SCHWERT
SWORD · ESPADA
EPEE · SPADA

Gewebespatel
Tissue Spatulas
Spatule à Tissu
Espátula para Tejidos



Cushing
18,0 cm/7"

- 18380-7** 7/9 mm
- 18380-11** 11/13 mm
- 18380-15** 15/16 mm
- 18380-18** 18/22 mm



100 mm

Heifetz
biegsam, maleable
maleable, maleable
20,0 cm/8"

- 18384-8** 8 mm
- 18384-11** 11 mm
- 18384-14** 14 mm
- 18384-17** 17 mm
- 18384-20** 20 mm



Olivecrona
18,0 cm/7"
Spatelbreite
Width of spatulas
Largeur de spatule
Anchura de espátulas



konkav	oben	unten	konvex
concave	upper end	lower end	convex
concave	en haut	en bas	convex
cóncava	arriba	abajo	convexa

18386-7	7 mm	9 mm	18387-7
18386-11	11 mm	13 mm	18387-11
18386-15	15 mm	18 mm	18387-15
18386-18	18 mm	22 mm	18387-18

Fadenführer
Ligature Guides
Passe-fils
Guia-ligaduras

Gefäßhäkchen
Vessel Hooks
Crochets à Bateaux
Ganchos para Vasos



SCHWERT
SWORD · ESPADA
EPEE · SPADA



Yasargil

Fig. 1

18834-1

18,5 cm/7¼"

Fadenführer, geknöpft
Ligature Guide, probe pointed
Passe-fil boutonné
Guia-ligadura, abotonado



Fig. 2

18834-2



Fig. 3

18834-3



Fig. 4

18834-4



Krayenbühl

Fig. 1

18835-1

18,5 cm/7¼"

Gefäßhäkchen
Vessel Hooks
Crochets à Bateaux
Ganchos para Vasos



Fig. 2

18835-2



Fig. 3

18835-3



Fig. 4

18835-4





SCHWERT
SWORD · ESPADA
EPEE · SPADA

Mikro-Häkchen
Micro Hooks
Micro-Crochets
Micro-Ganchitos



18837

18,5 cm/7¼"

Hauthäkchen
Skin Hooks
Petits crochets pour la peau
Ganchos para piel



Fisch

18,5 cm/7¼"

18838

Feines Häkchen
Delicate Hook
Crochet fin
Ganchito muy fino

Mikro-Raspatorien
 Micro Raspatories
 Micro-Rugines
 Micro-Periostótomos



SCHWERT
 SWORD · ESPADA
 EPEE · SPADA



Yasargil
 18,5 cm/7¼"

Mikro-Raspatorium
 Micro Raspatory
 Micro-rugine
 Micro-periostótomos

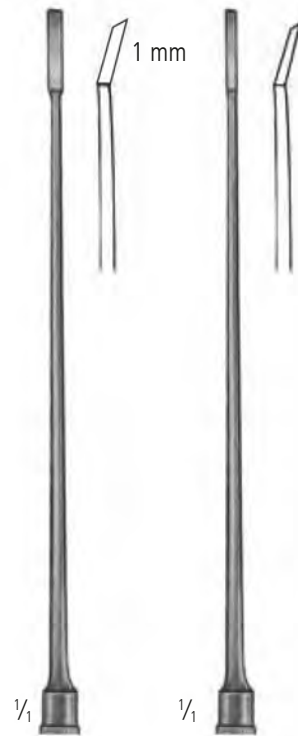

Fig. 1
18852-1

Fig. 2
18852-2



Fig. 4
18852-11

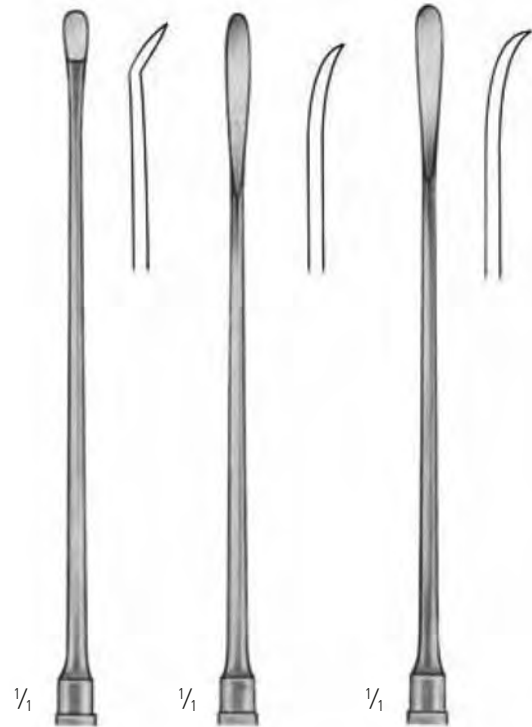

Fig. 4
18852-3

Fig. 5
18852-4

Fig. 6
18852-5



Galeahaken
Galea Hooks
Crochets de galeati
Gancho para galea

SCHWERT
SWORD · ESPADA
EPEE · SPADA

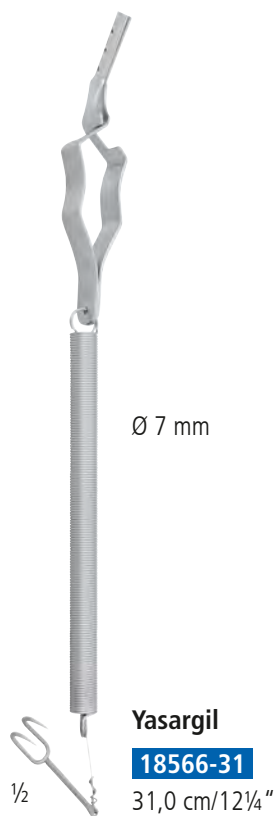
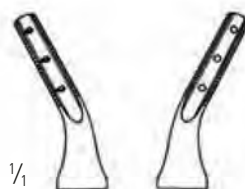

Dissektoren
Dissectors
Dissecteurs
Disecadores



SCHWERT
SWORD - ESPADA
EPEE - SPADA



Penfield
Fig. 1
18350-1
18,0 cm/7"



Penfield
Fig. 2
18350-2
20,0 cm/8"



Penfield
Fig. 3
18350-3
20,0 cm/8"



Penfield
Fig. 4
18350-4
21,5 cm/8½"



Penfield
Fig. 5
18350-5
29,0 cm/11½"



Dissektoren
Dissectors
Dissecteurs
Disecadores

SCHWERT
SWORD - ESPADA
EPEE - SPADA

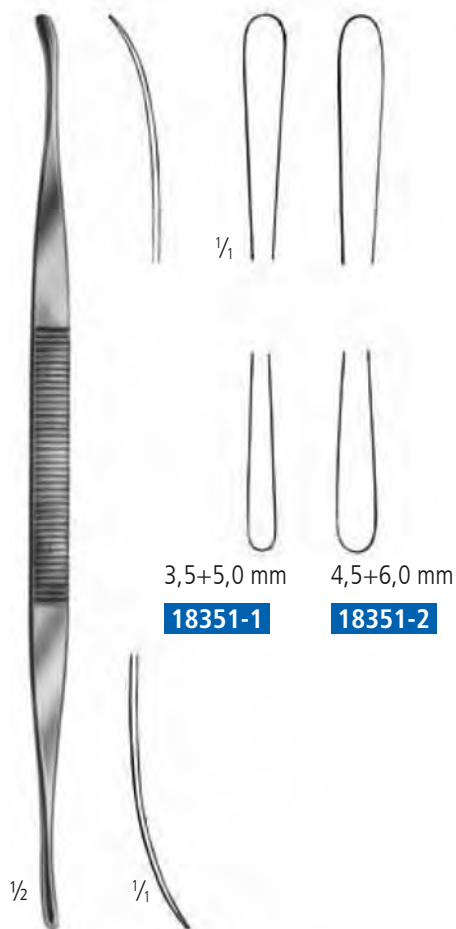

Toennis
24,0 cm/9 1/2"

18351-1

18351-2

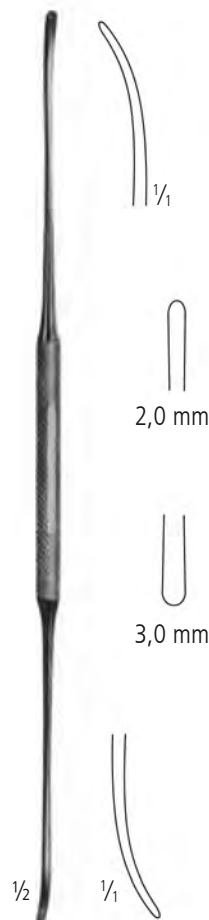

Olivecrona
2+3 mm

18352-18 18,0 cm/7"

18352-24 24,0 cm/9 1/2"

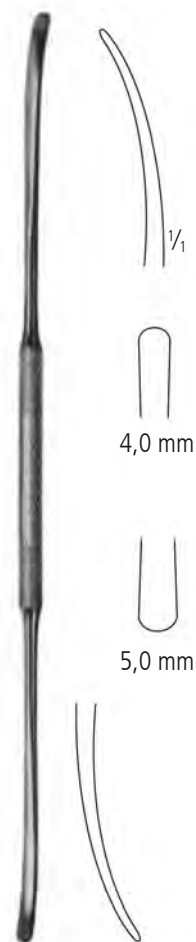

Olivecrona
4+5 mm

18353-18 18,0 cm/7"

18353-24 24,0 cm/9 1/2"

Separatoren
 Separators
 Séparateurs
 Separadores

Dissektoren
 Dissectors
 Dissecteurs
 Disecadores



SCHWERT
 SWORD · ESPADA
 EPEE · SPADA



Sachs

18354-1

21,0 cm/8 1/4"



Sachs

18354-2

21,0 cm/8 1/4"

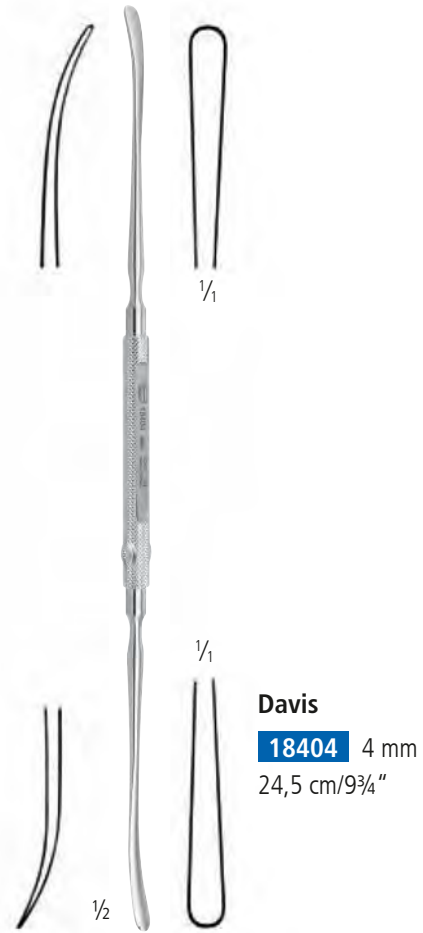

Davis

18404

4 mm

24,5 cm/9 3/4"



Frazier

18356

15,0 cm/6"



Hoen

18357-45

15,0 cm/6"



Hoen

18357-90

15,0 cm/6"

Separatoren
 Separators
 Séparateurs
 Separadores





SCHWERT
SWORD · ESPADA
EPEE · SPADA

**Wurzelhaken
Root Retractors
Retracteurs pour racines
Separadores de raíz**

**Separatoren
Separators
Séparateurs
Separadores**

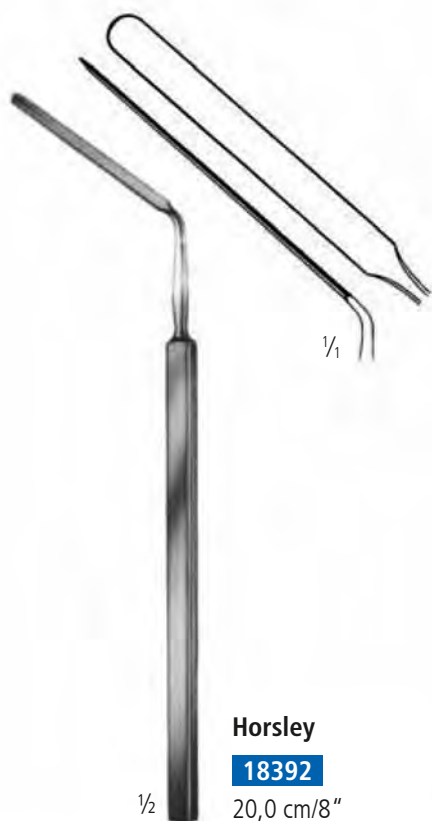

Horsley

18392

20,0 cm/8"

Separatoren
Separators
Séparateurs
Separadores



Love

Fig. 1

18366

19,0 cm/7½"

Love

Fig. 2

18367

19,0 cm/7½"

Love

Fig. 3

18368

19,0 cm/7½"

Gewebehaken
Tissue Hooks
Crochets pour tissus
Ganchos para tejidos



SCHWERT
SWORD · ESPADA
EPEE · SPADA



Scoville

18373-1

23,0 cm/9"
gerade, straight
droit, recto

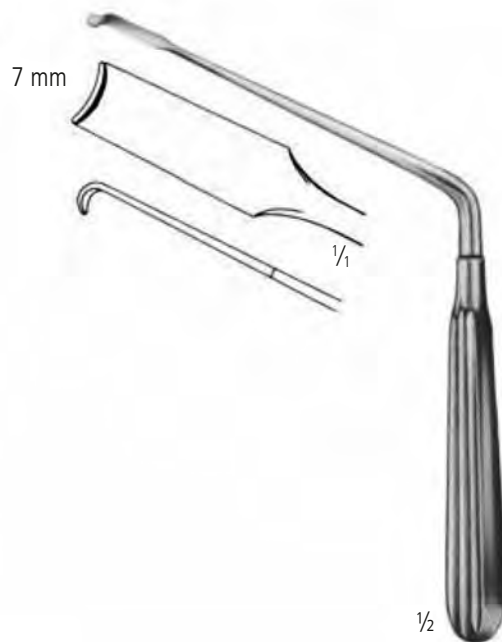

Scoville

18373-2

20,0 cm/8"
abgewinkel, angular
coudé, angular

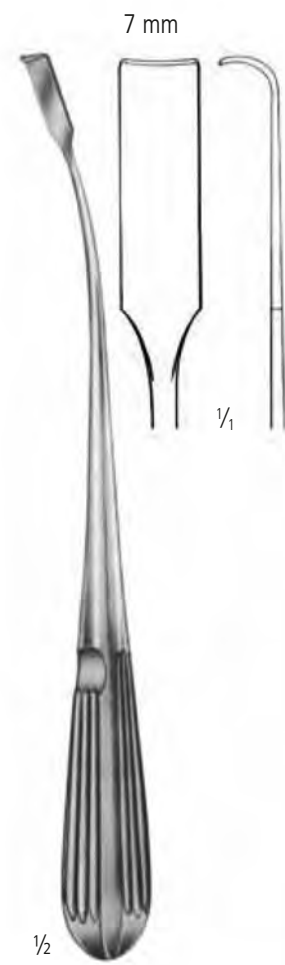

Holsher

18374

24,0 cm/9½"

1/2



SCHWERT
SWORD · ESPADA
EPEE · SPADA

**Gewebehaken
Tissue Hooks
Crochets pour tissus
Ganchos para tejidos**

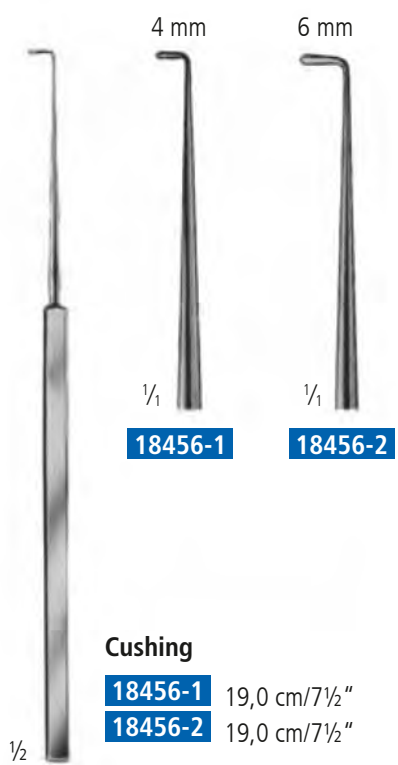

Cushing

18456-1 19,0 cm/7½"
18456-2 19,0 cm/7½"

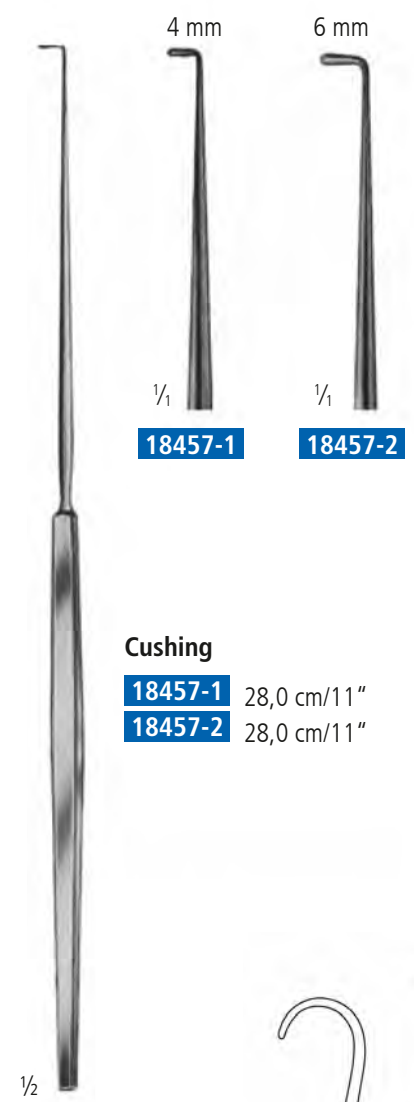

Cushing

18457-1 28,0 cm/11"
18457-2 28,0 cm/11"



Dandy

18459
20,0 cm/8"



Crile

18451-1
20,0 cm/8"

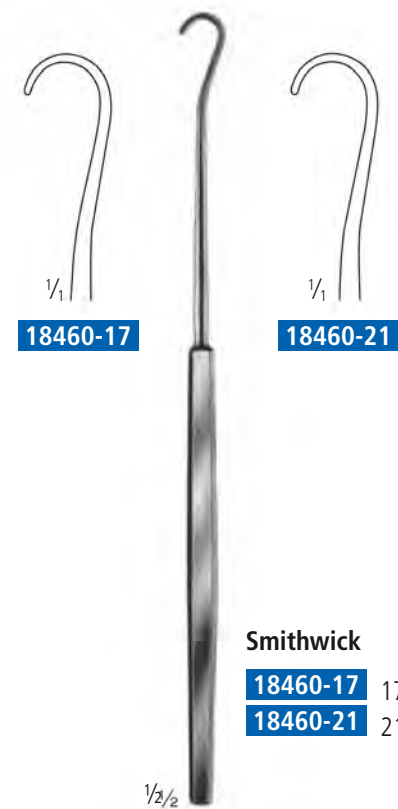

Smithwick

18460-17 17,0 cm/6½"
18460-21 21,0 cm/8¼"

**Mikromesser
Micro Knives
Micro-couteaux
Microcuchillos**

**Haut- und Gefäßhaken
Skin and Vessel Hooks
Crochets cutanés et vasculaires
Ganchos cutáneos y vasculares**



SCHWERT
SWORD · ESPADA
EPEE · SPADA



Adson
spitz, sharp
pointu, agudo

18430-1
20,0 cm/8"



Adson
stumpf, blunt
mousse, romo

18430-2
20,0 cm/8"



Frazier
spitz, sharp
pointu, agudo

18440-13 13,0 cm/5"
18440-18 18,0 cm/7"



Cushing
spitz, sharp
pointu, agudo

18432
14,0 cm/5½"

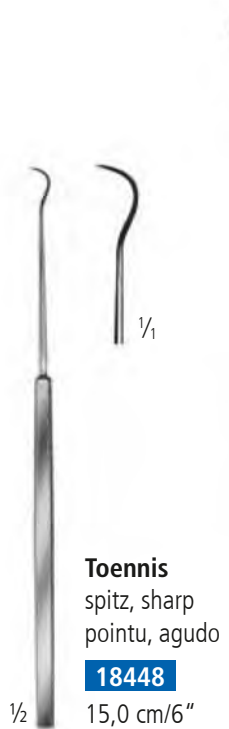

Toennis
spitz, sharp
pointu, agudo

18448
15,0 cm/6"



Sachs
spitz, sharp
pointu, agudo

18435
18,5 cm/7¼"



Graham
stumpf, blunt
mousse, romo

18436
16,5 cm/6½"



Halle

18485
20,0 cm/8"

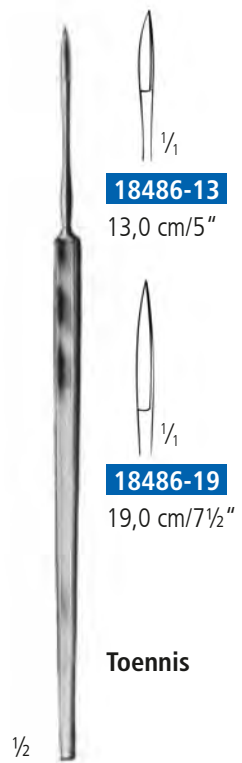

Toennis

18486-13
13,0 cm/5"

18486-19
19,0 cm/7½"



SCHWERT
SWORD · ESPADA
EPEE · SPADA

Bandscheiben-Rongeurs
Intervertebral Disc Rongeurs
Pinces à disques vertébrales
Pinzas para discos vertebrales

15,0 cm/6"



Cloward



gerade, straight
droite, recta

1/1

18201-1 6x10 mm



nach oben abgewinkel, angular upwards
angulée vers le haut, angular hacia arriba

1/1

18201-2 6x10 mm



nach unten abgewinkel, angular downwards
angulée vers le bas, angular hacia abajo

1/1

18201-3 6x10 mm

15,0 cm/6"



Schlesinger



18202-2 2x10 mm



18202-3 3x10 mm



18202-4 4x10 mm

1/1

Laminektomie-Zangen
 Laminectomy Rongeurs
 Pincas emporte-pièces à laminectomie
 Pinzas cortantes para laminectomia





SCHWERT
 SWORD · ESPADA
 EPEE · SPADA



Caspar

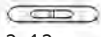

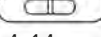

	 2x12 mm	 3x12 mm	 4x14 mm
15,5 cm/6''	18225-102	18225-103	18225-104
18,5 cm/7 1/4''	18225-202	18225-203	18225-204

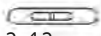
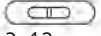
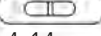

	 2x12 mm	 3x12 mm	 4x14 mm
15,5 cm/6''	18225-112	18225-113	18225-114
18,5 cm/7 1/4''	18225-212	18225-213	18225-214

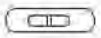

	 2x12 mm	 3x12 mm	 4x14 mm
15,5 cm/6''	18225-122	18225-123	18225-124
18,5 cm/7 1/4''	18225-222		



SCHWERT
SWORD · ESPADA
EPEE · SPADA

Bandscheiben-Rongeur
Intervertebral Disc Rongeurs
Pincès à disques vertébrales
Pinzas para discos vertebrales

20,0 cm/8"



5,5 mm

Laminektomie-Zange
Laminectomy Rongeur
Pince emporte-pièce a laminectomie
Pinza cortante para laminectomia

Wagner

18204

27,0 cm/11"

25,0 cm/10"

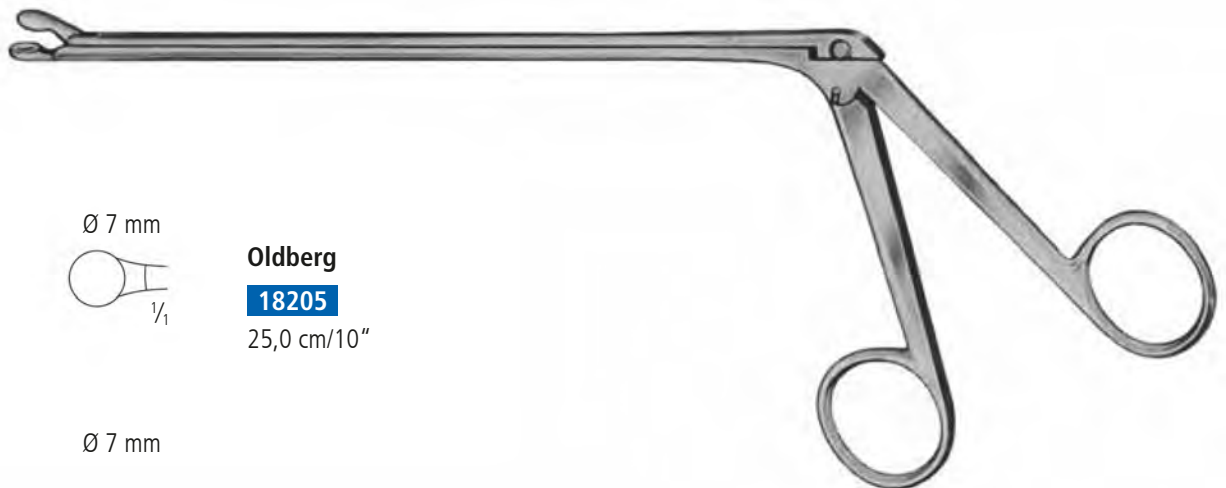

Ø 7 mm

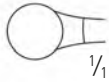

Oldberg

18205

25,0 cm/10"

Ø 7 mm

1/4

18,5 cm/7 1/4"

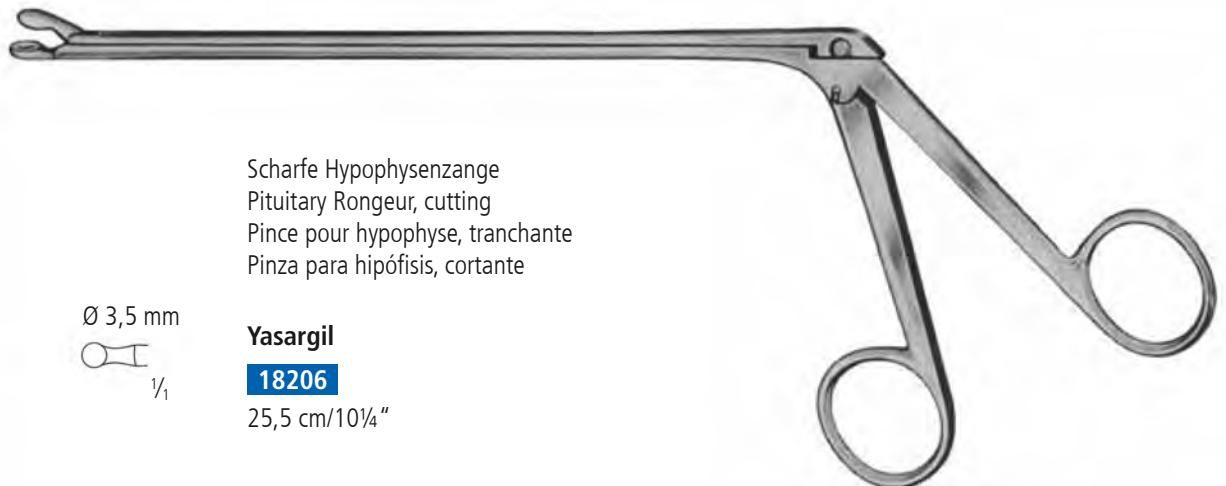

Ø 3,5 mm



Yasargil

18206

25,5 cm/10 1/4"

Scharfe Hypophysenzange
Pituitary Rongeur, cutting
Pince pour hypophyse, tranchante
Pinza para hipófisis, cortante

Bandscheiben-Rongeurs
Intervertebral Disc Rongeurs
Pinces à disques vertébrales
Pinzas para discos vertebrales



SCHWERT
 SWORD · ESPADA
 EPEE · SPADA

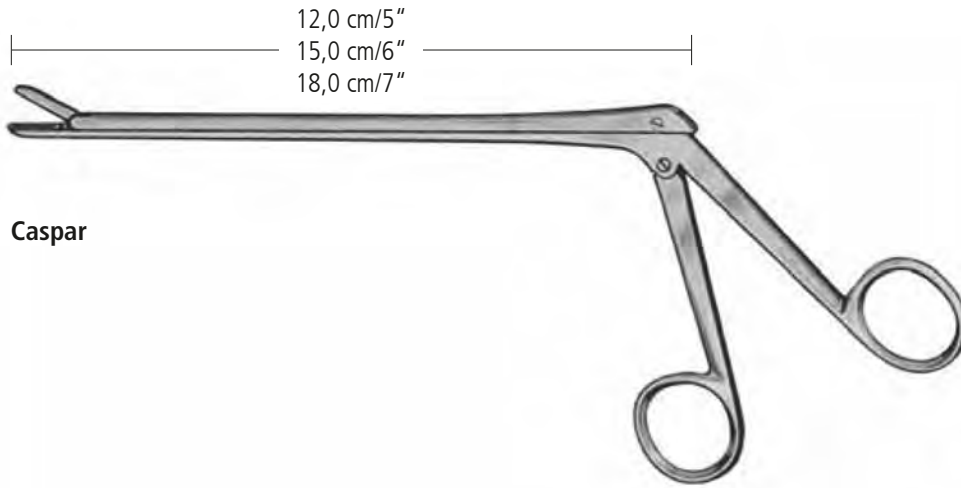

Caspar

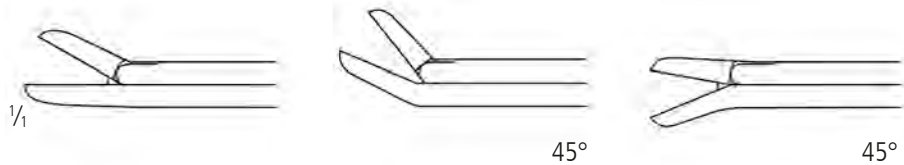

Cushing
2x10 mm

12,0 cm/5"	18225-2	18225-12	18225-22
15,0 cm/6"	18227-2	18227-12	18227-22
18,0 cm/7"	18226-2	18226-12	18226-22

Love-Gruenwald
3x10 mm

12,0 cm/5"	18225-3	18225-13	18225-23
15,0 cm/6"	18227-3	18227-13	18227-23
18,0 cm/7"	18226-3	18226-13	18226-23

Spurling
4x10 mm

12,0 cm/5"	18225-4	18225-14	18225-24
15,0 cm/6"	18227-4	18227-14	18227-24
18,0 cm/7"	18226-4	18226-14	18226-24



SCHWERT
SWORD · ESPADA
EPEE · SPADA

Bandscheiben-Rongeure Intervertebral Disc Rongeurs Pincers à disques vertébrales Pinzas para discos vertebrales

i

Ferris-Smith-Kerrison Stanzen

Die Ferris-Smith-Kerrison Stanzen wurden entwickelt, um den Operationsprozess an der Bandscheibe erfolgreich zu unterstützen. Die Stanzen sind mit einem Schaft in zwei verschiedenen Längen, sechs unterschiedlichen Bissbreiten, nach oben oder nach unten schneidend und in Edelstahlherhältlich. Der ergonomische Griff mit Rückholfeder ermöglicht ein präzises und optimiertes Arbeiten.

Ferris-Smith-Kerrison Punches

The Ferris-Smith-Kerrison Punches were developed in order to support surgical treatments on the intervertebral disc successfully. The punches are available with a shaft in two different lengths, in six different amplitudes, cutting upwards or cutting downwards and in stainless steel. The ergonomical handle with retaining spring allows a precise and optimal work.

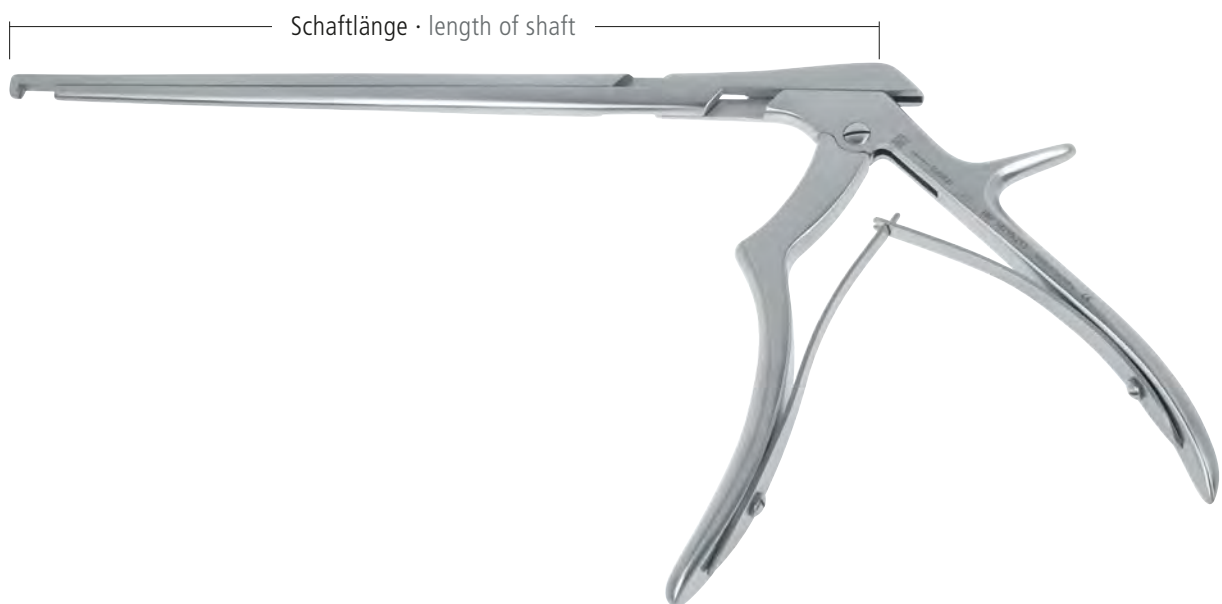
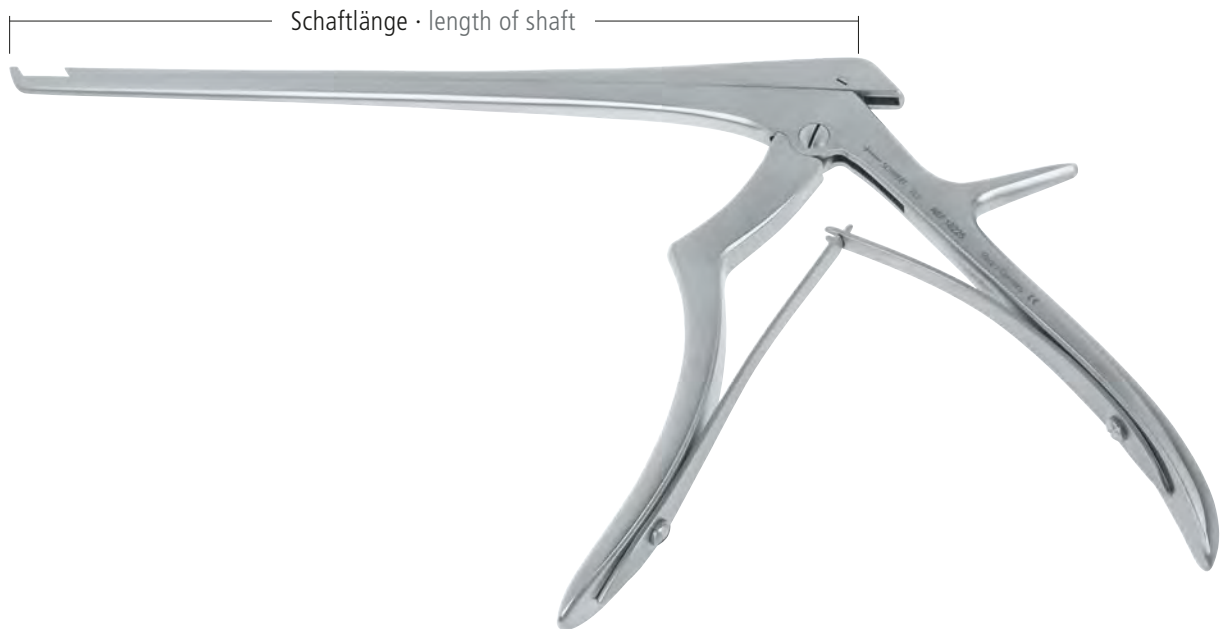

Bandscheiben-Rongeurs
Intervertebral Disc Rongeurs
Pinces à disques vertébrales
Pinzas para discos vertebrales



SCHWERT
 SWORD · ESPADA
 EPEE · SPADA



18210-24

Ferris-Smith-Kerrison
 Stanze, Bissbreite 4 mm,
 40° nach oben schneidend,
 Schaftlänge 180 mm
 Punch, width of bite 4 mm,
 40° upwards cutting,
 length of shaft 180 mm / 7 "

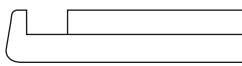

90° nach oben schneidend / Standard Öffnung 10 mm
 90° upwards cutting / standard opening 10 mm

Schaftlänge length of shaft	Bissbreite · width of bite					
	1 mm	2 mm	3 mm	4 mm	5 mm	6 mm
180 mm	18210-1	18210-2	18210-3	18210-4	18210-5	18210-6
200 mm	18210-201	18210-202	18210-203	18210-204	18210-205	18210-206

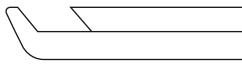

40° nach oben schneidend / Standard Öffnung 10 mm
 40° upwards cutting / standard opening 10 mm

Schaftlänge length of shaft	Bissbreite · width of bite					
	1 mm	2 mm	3 mm	4 mm	5 mm	6 mm
180 mm	18210-21	18210-22	18210-23	18210-24	18210-25	18210-26
200 mm	18210-221	18210-222	18210-223	18210-224	18210-225	18210-226



90° nach unten schneidend / Standard Öffnung 10 mm
 90° downwards cutting / standard opening 10 mm

Schaftlänge length of shaft	Bissbreite · width of bite					
	1 mm	2 mm	3 mm	4 mm	5 mm	6 mm
180 mm	18210-11	18210-12	18210-13	18210-14	18210-15	18210-16
200 mm	18210-211	18210-212	18210-213	18210-214	18210-215	18210-216



SCHWERT
SWORD · ESPADA
EPEE · SPADA

Bandscheibenstanzen
Intervertebral Disc Rongeurs
Pinces à disques vertébrales
Pinzas cortantes para discos intervertebrales

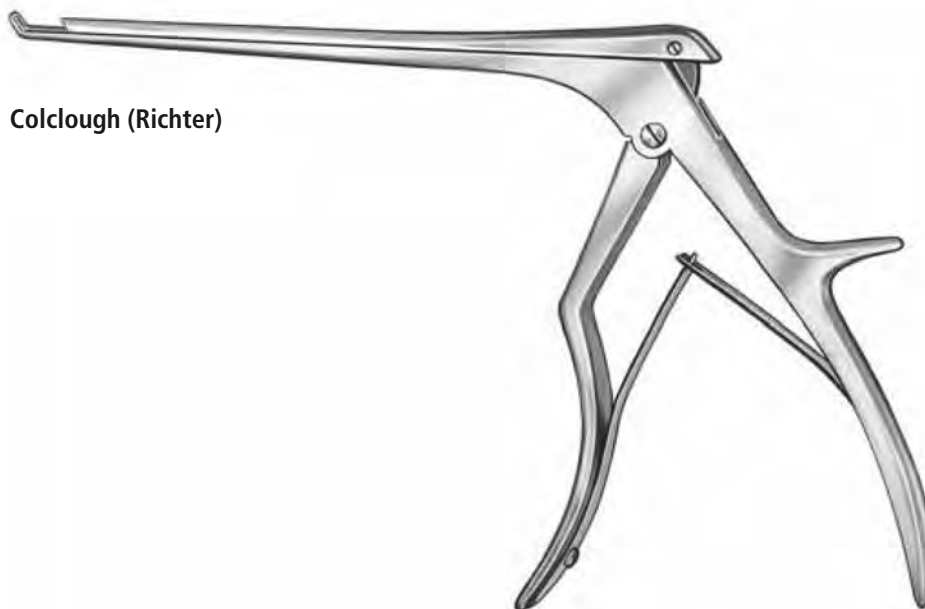

Colclough (Richter)

	90° nach oben schneidend 90° upwards cutting coupante ver le haut 90° cortante hacia arriba 90°	Bissbreite Width of bite Grandeur de coupe Ancho de la boca	Schaftlänge, Length of shaft Longueur de tige, Largo del asta		
			15,0 cm/6"	18,0 cm/7"	20,0 cm/8"
1/4 □		2 mm	18195-2	18196-2	18196-52
□		3 mm	18195-3	18196-3	18196-53
□		4 mm	18195-4	18196-4	18196-54
□		5 mm	18195-5	18196-5	18196-55
□		6 mm	18195-6	18195-6	18226-26

Bandscheibenstanzen
Intervertebral Disc Rongeurs
Pinces à disques vertébrales
Pinzas cortantes para discos intervertebrales



SCHWERT
 SWORD · ESPADA
 EPEE · SPADA

Colclough (Richter)

	40° nach oben schneidend 490° upwards cutting coupante ver le haut 40° cortante hacia arriba 40°	Bissbreite Width of bite Grandeur de coupe Ancho de la boca	Schaftlänge, Length of shaft Longueur de tige, Largo del asta		
			15,0 cm/6"	18,0 cm/7"	20,0 cm/8"
1/4		2 mm	18196-102	18196-22	18196-202
		3 mm	18196-103	18196-23	18196-203
		4 mm	18196-104	18196-24	18196-204
		5 mm	18196-105	18196-25	18196-205
		6 mm	18196-106	18196-26	18196-206

	90° nach unten schneidend 90° downwards cutting coupante vers le bas 90° cortante hacia abajo 90°	Bissbreite Width of bite Grandeur de coupe Ancho de la boca	Schaftlänge, Length of shaft Longueur de tige, Largo del asta		
			15,0 cm/6"	18,0 cm/7"	20,0 cm/8"
1/4		2 mm	18197-102	18197-22	18196-202
		3 mm	18197-103	18197-23	18196-203
		4 mm	18197-104	18197-24	18196-204
		5 mm	18197-105	18197-25	18196-205
		6 mm	18197-106	18196-26	18196-206



SCHWERT
SWORD · ESPADA
EPEE · SPADA

Laminektomiespreizer
Laminectomy Spreaders
Ecarteurs pour laminectomie
Separadores para laminectomia

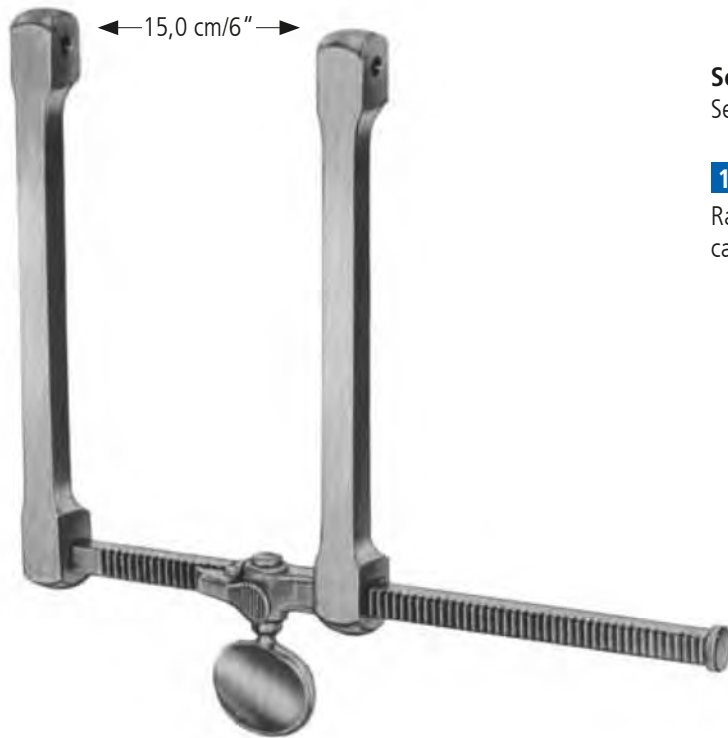

Scoville

Set, set, série, juego

18140-1

Rahmen allein, frame only
cadre seul, cuadro solo



Scoville-Haverfield

Set, set, série, juego

18141-1

Rahmen allein, frame only
cadre seul, cuadro solo

Laminektomiespreizer Laminectomy Spreaders Ecarteurs pour laminectomie Separadores para laminectomia



SCHWERT
SWORD · ESPADA
EPEE · SPADA

Haken, Hooks, Crochets, Separadores



Scoville
stumpf, blunt
mousse, romo

- 18142-5** 50 mm/2"
- 18142-7** 70 mm/2¾"
- 18142-8** 75 mm/3"



Scoville
spitz, sharp
pointu, agudo

- 18142-15** 50 mm/2"
- 18142-17** 70 mm/2¾"
- 18142-18** 75 mm/3"

Valven, Blades, Valves, Valvas



Scoville

- 18143-1** 64x25 mm
- 18143-2** 64x29 mm
- 18143-3** 64x50 mm
- 18143-4** 88x25 mm



Taylor

- 18144-1** 48x50 mm
- 18144-2** 64x50 mm
- 18144-3** 64x64 mm
- 18144-4** 80x57 mm



gezahnt
saw edge
dentelée
dentada

Meyerding-Scoville

- 18147-1** 50x25 mm
- 18147-2** 70x25 mm
- 18147-3** 83x25 mm



SCHWERT
SWORD · ESPADA
EPEE · SPADA

Laminektomiespreizer Laminectomy Spreaders Ecarteurs pour laminectomie Separadores para laminectomia



Cloward

15730-25 25,0 cm/9½"
Sperrer allein, spreader only
ecarteur seule, separador solo

15730-75 25,0 cm/9½"
Set mit 5 gezahnten Valven **15730-A40 - 15730-A60**
Set with 5 toothed blades **15730-A40 - 15730-A60**
Jeu avec 5 valves dentelées **15730-A40 - 15730-A60**
Juego con 5 valvas dentadas **15730-A40 - 15730-A60**



Valve, gezahnt
Blade, saw edge
Valve, dentelée
Valva, dentada

15730-A40 40 mm
15730-A45 45 mm
15730-A50 50 mm
15730-A55 55 mm
15730-A60 60 mm



Valve, stumpf
Blade, blunt
Valve, mousse
Valva, roma

15730-B40 40 mm
15730-B45 45 mm
15730-B50 50 mm
15730-B55 55 mm
15730-B60 60 mm



SCHWERT
SWORD · ESPADA
EPEE · SPADA

Augeninstrumente

Ophthalmological Instruments

Instrumentes ophtalmologiques

Instrumentes para oftalmologia

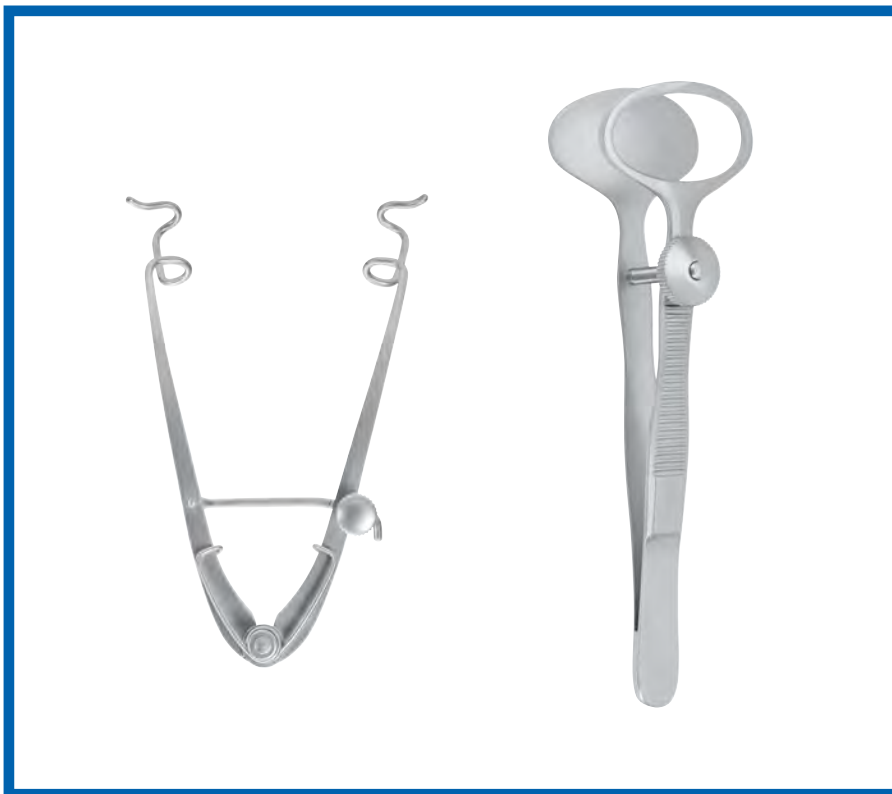



SCHWERT
SWORD · ESPADA
EPEE · SPADA

Irispinzetten
Iris Forceps
Pinces pour l'iris
Pinzas para iris



Fixierpinzette
Fixation Forceps
Pince a fixation
Pinzas de fijación

Elschnig
10,5 cm/4¼"

19728



Fischer
7,0 cm/2¾"

19623



Gill
7,5 cm/3"

19630



Zähne unten
Teeth downwards
Dents vers le bas
Dientes hacia abajo

Gill-Hess
7,5 cm/3"

19631



19632

Zähne seitwärts
Teeth lateral
Dents latérales
Dientes laterales



Graefe
10,0 cm/4"
0,9 mm

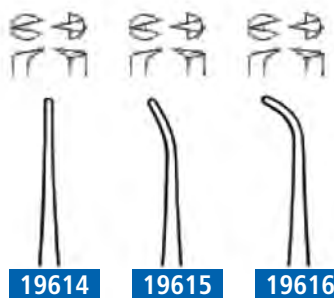
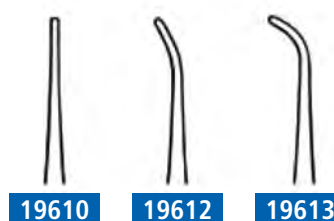

Irispinzetten
Iris Forceps
Pinces pour l'iris
Pinzas para iris



SCHWERT
 SWORD · ESPADA
 EPEE · SPADA



ohne Sperre
 without ratchet
 sans crémaillère
 sin cremallera

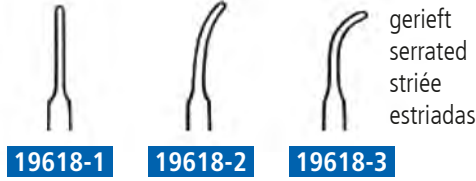

19618-1 **19618-2** **19618-3**



19620-1 **19620-2** **19620-3**

Stevens
 10,5 cm/4¼"



mit Sperre
 with ratchet
 avec crémaillère
 con cremallera

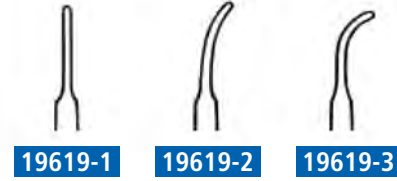

19619-1 **19619-2** **19619-3**



19621-1 **19621-2** **19621-3**

Stevens
 10,5 cm/4¼"



19626

19627

Hess
 7,0 cm/2¾"

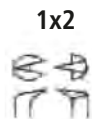

ohne Stift
 without pin
 sans cheville
 sin perno

Mod. Bonn
19640
 7,0 cm/2¾"

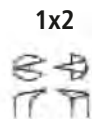

mit Stift
 with pin
 avec cheville
 con perno

Mod. Bonn
19641
 7,0 cm/2¾"



19642
 0,8 mm
 gerieft
 serrated
 striée
 estriadas

19643
 0,4 mm
 gerieft
 serrated
 striée
 estriadas

Bishop-Harmon
 8,5 cm/3½"



19644
 0,8 mm

19645
 0,4 mm

Bishop-Harmon
 8,5 cm/3½"





SCHWERT
SWORD · ESPADA
EPEE · SPADA

Kapselpinzetten
Capsular Forceps
Pinces capsulaires
Pinzas capsulares

Fadenpinzetten
Suture Forceps
Pinces à sutures
Pinzas para sutura

Kapselpinzetten, Capsular Forceps, Pinces capsulaires, Pinzas capsulares



Gill-Arruga

19664

7,5 cm/3"

Arruga

19665

9,5 cm/3¾"

Schweiger

19666

10,0 cm/4"

Kapselsauger
Erisophakes
Aspirateurs capsulaires
Aspirador capsular



Dastoor

19670

6,0 cm/2½"

Fadenpinzetten, Suture Forceps, Pinces à sutures, Pinzas para sutura

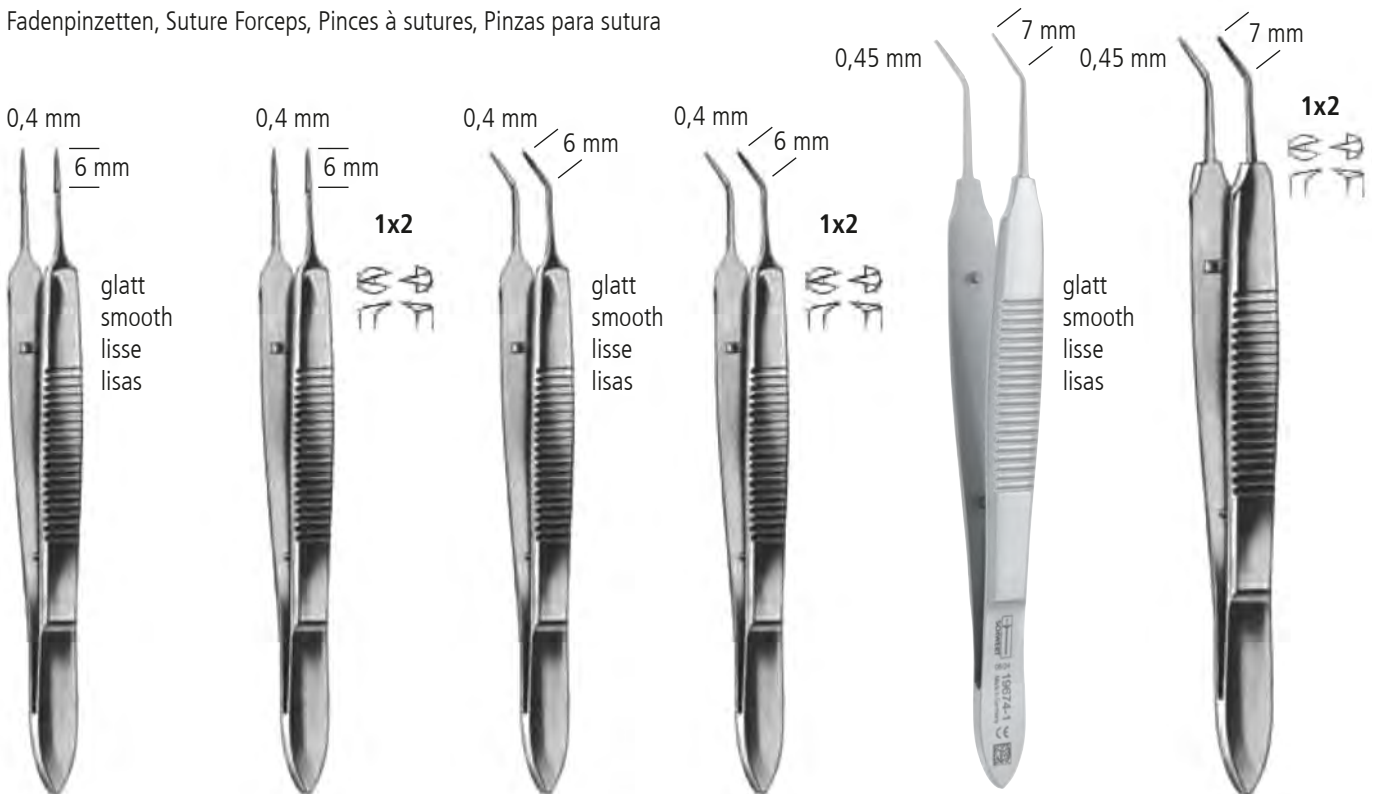

McPherson

19672-1

8,5 cm/3½"

McPherson

19672-2

8,5 cm/3½"

McPherson

19673-1

8,5 cm/3½"

McPherson

19673-2

8,5 cm/3½"

McPherson

19674-1

10,0 cm/4"

McPherson

19674-2

10,0 cm/4"

Fixierpinzetten
Fixation Forceps
Pinces à fixation
Pinzas de fijación

Nahtpinzetten
Suture Forceps
Pinces à sutures
Pinzas para sutura



SCHWERT
 SWORD · ESPADA
 EPEE · SPADA



ohne Schloss
 without catch
 sans arrêt
 sin cierre

Graefe

19678

11,0 cm/4½"



mit Schloss
 with catch
 avec arrêt
 con cierre

Graefe

19680

11,0 cm/4½"



Barraquer

19682

10,0 cm/4"



19692-5 5 mm
19692-10 10 mm
 mit Schloss
 with catch
 avec arrêt
 con cierre

19693-5 5 mm
19693-10 10 mm
 ohne Schloss
 without catch
 sans arrêt
 sin cierre

Green

10,0 cm/4"

2x2

Nahtpinzetten
 Suture Forceps
 Pinces à sutures
 Pinzas para sutura



19694

gerade
 straight
 droite
 rectas

19695

gerade
 straight
 droite
 rectas

Castroviejo 2x2

9,0 cm/3¾"



SCHWERT
SWORD · ESPADA
EPEE · SPADA

Nahtpinzetten
Suture Forceps
Pinces à sutures
Pinzas para sutura

Strabismuspinzetten
Strabismus Forceps
Pinces à strabisme
Pinzas para estrabismo

Nahtpinzetten, Suture Forceps, Pinces à sutures, Pinzas para sutura

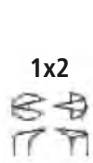

St. Martin

19710

7,0 cm/2¾"



Castroviejo

10,0 cm/4"

19703-5 0,5 mm
19703-10 1,0 mm
gerade
straight
droite
rectas



Castroviejo

10,0 cm/4"

19704-5 0,5 mm
19704-10 1,0 mm
gebogen
curved
courbe
curvas



Castroviejo

10,0 cm/4"

19705-5 0,5 mm
19705-9 0,9 mm
gerade
straight
droite
rectas

Strabismuspinzetten, Strabismus Forceps, Pinces à strabisme, Pinzas para estrabismo



Bonaccolto

19701

10,0 cm/4"



19711

11,0 cm/4½"

gerieft
serrated
striée
estriadas



19712

11,0 cm/4½"

gerieft
serrated
striée
estriadas

Strabismuspinzetten
Strabismus Forceps
Pinces à strabisme
Pinzas para estrabismo

Nahtpinzetten
Suture Forceps
Pinces à sutures
Pinzas para sutura

Chalazionspinzetten
Chalazion Forceps
Pinces à chalazion
Pinzas para chalación

Trachompinzette
 Trachoma Forceps
 Pince pour le trachome
 Pinzas para tracoma

Chalazionspinzetten, Chalazion Forceps, Pinces à chalazion, Pinzas para chalación



Desmarres
 9,0 cm/3½"

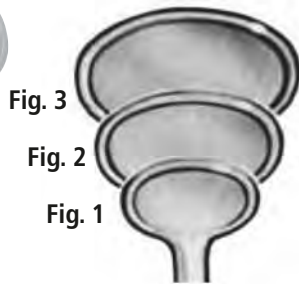

Fig. 3

Fig. 2

Fig. 1

Fig. 1

19774-20

20 mm

Fig. 2

19774-25

25 mm

Fig. 3

19774-30

30 mm



Ayer
19776
 9,0 cm/3½"



Lambert
19786
 9,5 cm/3½"



Prince
19777
 9,0 cm/3½"



19790-1 1x2
 10,0 cm/4"

Strabismuspinzetten
 Strabismus Forceps
 Pinces à strabisme
 Pinzas para estrabismo



Nahtpinzetten
 Suture Forceps
 Pinces à sutures
 Pinzas para sutura



Castroviejo 1x1
 9,0 cm/3½"

19791

mit Schloss
 with catch
 avec arrêt
 con cierre

19792

ohne Schloss
 without catch
 sans arrêt
 sin cierre



SCHWERT
 SWORD · ESPADA
 EPEE · SPADA

Cilienpinzetten
Cilia Forceps
Pinces à épiler les cils
Pinzas para depilación

Cilienpinzetten, Cilia Forceps, Pinces à épiler les cils, Pinzas para depilación



Gradle

19745

9,5 cm/3¾"

Entropiumpinzetten
Entropium Forceps
Pinces à entropion
Pinzas de entropión



Beaupré

19747

12,0 cm/4¾"

Knüpfpinzetten
Suture Tying Forceps
Pinces à poser des ligatures
Pinzas para poner ligaduras



Barraquer

19740

10,5 cm/4¼"

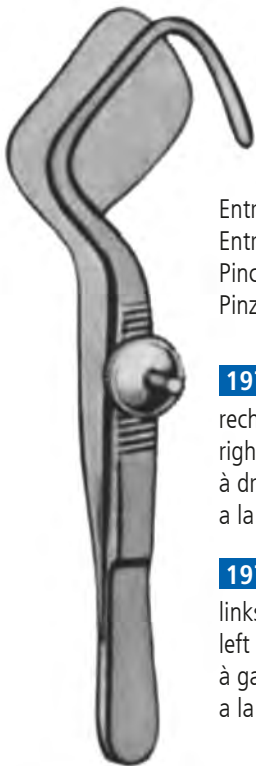

Entropiumpinzetten
 Entropium Forceps
 Pinces à entropion
 Pinzas de entropión

19763-1

rechts
 right
 à droite
 a la derecha

19763-2

links
 left
 à gauche
 a la izquierda

Snellen
 10,0 cm/4"



1x2



0,2 mm

Knüpfpinzetten
 Suture Tying Forceps
 Pinces à poser des ligatures
 Pinzas para poner ligaduras

19750

9,5 cm/3¾"

**Augensonden
Lachrymal Probes
Sandes pour le canal lacrymal
Estiletos para el canal lacrimal**



SCHWERT
SWORD · ESPADA
EPEE · SPADA



Bowman

zylindrisch
cylindrical
cylindrique
cilindrico

Edelstahl
Stainless steel
Acier inox
Acero inox.

Fig.	Ø mm	
000/00	0,8 / 0,7	19045-30
00/0	0,9 / 0,8	19045-20
0/1	1,0 / 0,9	19045-10
1/2	1,1 / 1,0	19045-1
2/3	1,2 / 1,1	19045-2
3/4	1,3 / 1,2	19045-3
4/5	1,4 / 1,3	19045-4
5/5	1,5 / 1,4	19045-5
6/7	1,6 / 1,5	19045-6
7/8	1,7 / 1,6	19045-7



SCHWERT
SWORD - ESPADA
EPEE - SPADA

Verschiedene Augenmesser Various Eye Knives Couteaux divers pour les yeux Cuchillos diversos para los ojos

Starmesser, Cataract Knives, Couteaux a cataracte, Cuchillos para catarata



Graefe
12,5 cm/5"

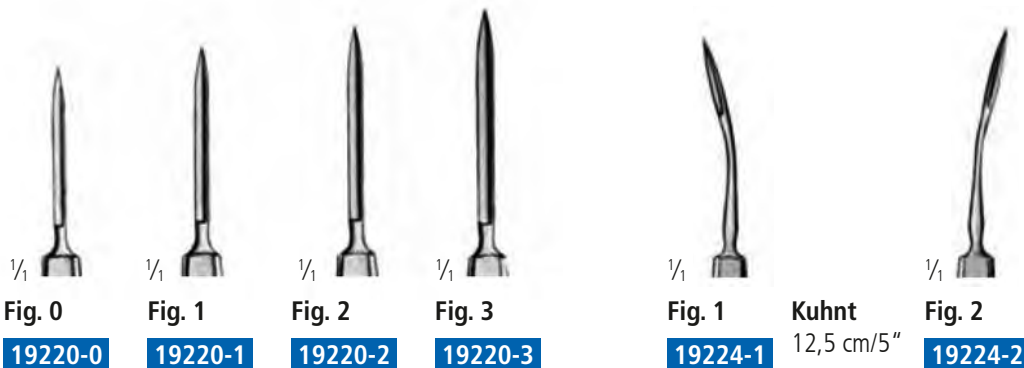

Kuhnt
12,5 cm/5"

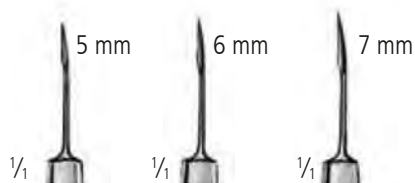

Irismesser
Iris Knives
Couteaux pour l'iris
Cuchillos para iris



Ziegler
11,5 cm/4½"

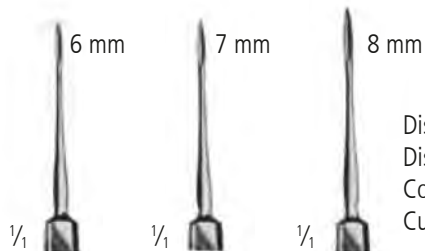

Diszisionsmesser
Discission Knives
Couteaux à discission
Cuchillos para discisión



Knapp
12,5 cm/5"

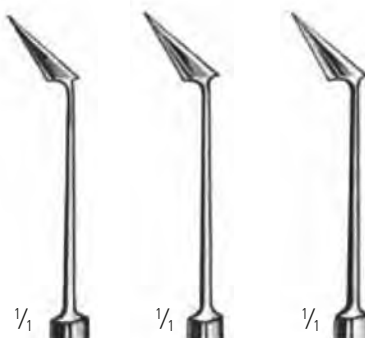

Biegung 45°
Curvature 45°
Courbure de 45°
Curvatura 45°

Lanzenmesser
Keratomes
Couteaux lancéolaires
Cuchillos lanceolares

Wessely-Grieshaber
13,5 cm/5¾"

Fremdkörperinstrumente
Foreign Body Instruments
Instrumentos à corps étrangers
Instrumentos para cuerpos extraños



SCHWERT
 SWORD · ESPADA
 EPEE · SPADA

Starnadel
 Cataract Needle
 Aiguille à cataracte
 Aguja para catarata

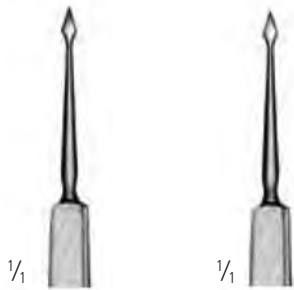

19336

12,0 cm/4¾"
 gerade
 straight
 droite
 recta

19337

12,0 cm/4¾"
 gebogen
 curved
 courbe
 curva

Fremdkörpernadel
 Foreign Body Needle
 Aiguille à corps étrangers
 Aguja para cuerpos extraños

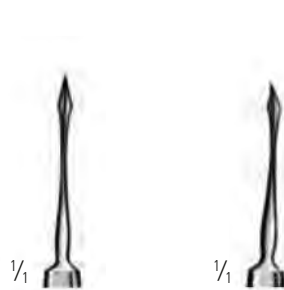

19360

12,0 cm/4¾"
 gerade
 straight
 droite
 recta

19361

12,0 cm/4¾"
 gebogen
 curved
 courbe
 curva

Fremdkörper-Hohlmeißel
 Gouge for foreign bodies
 Gouge pour corps étrangers
 Gubia para cuerpos extraños

1,2 mm



Meyer

19365

12,0 cm/4¾"

Nadel und Flachmeißel
 Needle and Chisel
 Aiguille et burin
 Aguja y cincel

Nadel und Hohlmeißel
 Needle and Gouge
 Aiguille et gouge
 Aguja y gubia



runder Griff
 round handle
 manche ronde
 mango redondo

Dix

19054-1

Dix

19054-2



SCHWERT
SWORD · ESPADA
EPEE · SPADA

Fremdkörperinstrumente
Foreign Body Instruments
Instrumentos à corps étrangers
Instrumentos para cuerpos extraños

Augenhäkchen
Eye Hooks
Crochets pour les yeux
Ganchos para los ojos



Nadel und Hohlmeißel
Needle and Gouge
Aiguille et gouge
Aguja y gubia

Graefe

19056-3

Augenhäkchen, Eye Hooks, Crochets pour les yeux, Ganchos para los ojos



scharf
sharp
pointu
agudo

1/1

Guthrie
12,0 cm/4 3/4"

Fig.1

19394

scharf
sharp
pointu
agudo

1/1

Guthrie
13,0 cm/5 1/4"

Fig.2

19395

scharf
sharp
pointu
agudo

1/1

Graefe
12,0 cm/4 3/4"

Fig.1

19390

stumpf
blunt
mousse
romo

1/1

Fig.2

19391

scharf
sharp
pointu
agudo

1/1

Wiener
12,5 cm/5"

Fig.1

19396-1

stumpf
blunt
mousse
romo

1/1

Fig.2

19396-2

scharf
sharp
pointu
agudo

1/1

Jaeger
13,0 cm/5 1/4"

Fig.1

19397-1

scharf
sharp
pointu
agudo

1/1

Fig.2

19397-2

Schielhaken
Strabismus Hooks
Crochets à strabisme
Ganchos para estrabismo

Tränenkanal-Dilatatoren
Lachrymal Dilators
Dilatateurs pour le canal lacrymal
Dilatadores para canal lacrimal



SCHWERT
SWORD · ESPADA
EPEE · SPADA

Schielhaken, Strabismus Hooks, Crochets à strabisme, Ganchos para estrabismo



Graefe

stumpf
blunt
mousse
romo



1/1

Fig. 1

19420-1

13,0 cm/5 1/4"



1/1

Fig. 2

19420-2

14,0 cm/5 1/2"



1/1

Fig. 3

19420-3

15,0 cm/6"

Tränenkanal-Dilatatoren, Lachrymal Dilators, Dilatateurs pour le canal lacrymal, Dilatadores para canal lacrimal

spitz
sharp
pointu
agudo



1/1

Fig. 1

19502-1

Wilder
11,0 cm/4 1/2"



1/1

Fig. 2

19502-2



1/1

Fig. 3

19502-3



SCHWERT
SWORD · ESPADA
EPEE · SPADA

Chalazionslöffel
Chalazion Curettes
Curettes à chalazion
Cucharillas para chalazión

Exenterationslöffel
Exenteration Scoops
Curettes pour exentération
Cucharillas para exentación

Chalazionslöffel, Chalazion Curettes, Curettes à chalazion, Cucharillas para chalazión



Ø 0,5 mm 1,0 mm 1,5 mm 1,8 mm 2,0 mm 2,5 mm 3,5 mm 4,0 mm 4,5 mm

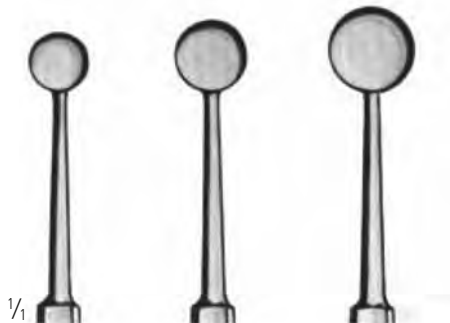

Fig. 0 **Fig. 1** **Fig. 2** **Fig. 3** **Fig. 4** **Fig. 5** **Fig. 6** **Fig. 7** **Fig. 8**
19491-0 **19491-1** **19491-2** **19491-3** **19491-4** **19491-5** **19491-6** **19491-7** **19491-8**

scharf
sharp
tranchante
cortante

Meyhoefer
13,0 cm/5¼"

Exenterationslöffel, Exenteration Scoops, Curettes pour exentération, Cucharillas para exentación



Bunge
14,5 cm/5¾"

Fig. 1 **Fig. 2** **Fig. 3**
19493-1 **19493-2** **19493-3**

Sperrelevatoren
Eye Specula
Blépharostats
Blefarostatos



SCHWERT
SWORD · ESPADA
EPEE · SPADA



Mellinger-Beard

19121 5,0 cm/2"
für Kinder
for children
pour enfants
para niños

19122 7,0 cm/2¾"
für Erwachsene
for adults
pour adultes
para adultos

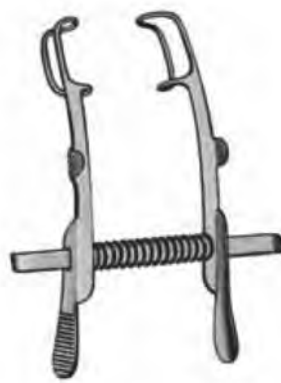

Mellinger

19119 5,0 cm/2"
für Kinder
for children
pour enfants
para niños

19120 7,0 cm/2¾"
für Erwachsene
for adults
pour adultes
para adultos

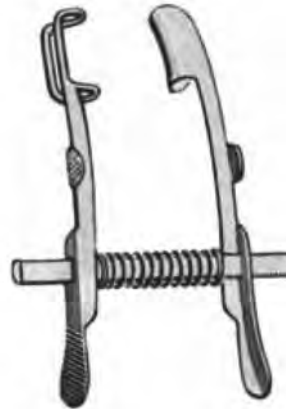

Mellinger-Axenfeld

19125-1 7,0 cm/2¾"
rechts
to the right
à droite
a la derecha

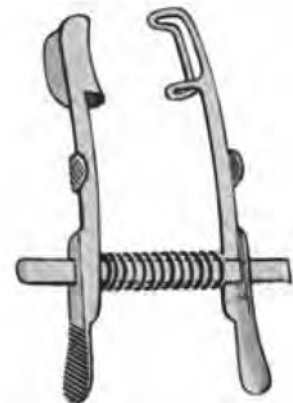

Mellinger-Axenfeld

19125-2 7,0 cm/2¾"
links
to the left
à gauche
a la izquierda



Murdock

19126
5,0 cm/2"



Mueller

19127
7,0 cm/2¾"



Goldstein

19128
3,0 cm/1¼"



Park-Guyton

19139
8,0 cm/3¼"



Knapp-Clark

19140
8,0 cm/3¼"



Williams

19141 7,0 cm/2¾"
für Kinder
for children
pour enfants
para niños

19142 8,0 cm/2¼"
für Erwachsene
for adults
pour adultes
para adultos



SCHWERT
SWORD · ESPADA
EPEE · SPADA

Sperrelevatoren Eye Specula Blépharostats Blefarostatos



Lister-Burch

19143

8,0 cm/3¼"



Alm

15706-7

7,0 cm/2¾"

15705-7

15706-10

10,0 cm/4"

15705-10

scharf
sharp
pointu
agudo

stumpf
blunt
mousse
romo



Stevenson

19145

7,0 cm/2¾"



Castroviejo

19136

8,0 cm/3¼"



Lancaster

19146

7,0 cm/2¾"



Bowman

19150

7,0 cm/2¾"

Lidhalter
Lid Retractor
Ecarteurs à paupières
Separadores de párpados

Markierungszirkel
Marker graduated
Marqueur gradué
Marcador graduado



SCHWERT
 SWORD · ESPADA
 EPEE · SPADA

Lidhalter, Lid Retractor, Ecarteurs à paupières, Separadores de párpados



6 mm

für Kinder
 for children
 pour enfants
 para niños

Desmarres

19072

13,0 cm/5¼"



Fig. 1

19073-1 12 mm

Fig. 2

19073-2 14 mm

Fig. 3

19073-3 16 mm

Fig. 4

19073-4 18 mm

Desmarres

13,0 cm/5¼"

Markierungszirkel. Nur zur Vergleichsmessung.
 Marker graduated. Only for comparison measurement.
 Marqueur gradué. Pour une mesure comparative uniquement.
 Marcador graduado. Sólo a efectos comparativos.



Messbereich
 Measuring Range
 Echelle
 Alcance de medición

19065-15 15 mm

19065-20 20 mm

Castroviejo



SCHWERT
SWORD · ESPADA
EPEE · SPADA

Nachstarscheren
Secondary Cataract Scissors
Ciseaux pour la cataracte secondaire
Tijeras para catarata secundaria

Mikro-Scheren
Micro Scissors
Micro-Ciseaux
Micro Tijeras

Nachstarscheren, Secondary Cataract Scissors
Ciseaux pour la cataracte secondaire, Tijeras para catarata secundaria

Mikro-Scheren
Micro Scissors
Micro-Ciseaux
Micro Tijeras



gerade
straight
droits
rectas

Vannas

19831

8,0 cm/3¼"



gebogen
curved
courbes
curvas

Vannas

19832

8,0 cm/3¼"



seitwärts abgewinkelt
angular on side
coudé a la côte
acodada lateral

Vannas

19833

8,0 cm/3¼"



Mc Clure

19834-10

10,0 cm/4"



Mc Clure

19834-11

11,0 cm/4½"

Mikro-Hornhautscheren, Micro Corneal Scissors, Micro-Ciseaux pour la corneé, Micro Tijeras para córnea



links
to the left
à gauche
a la izquierda

Troutman

19835-1

10,0 cm/4"



rechts
to the right
à droite
a la derecha

Troutman

19835-2

10,0 cm/4"



links
to the left
à gauche
a la izquierda

Troutman

19836-1

10,0 cm/4"

mit Sperre
with ratchet
avec arrêt
con cierre



rechts
to the right
à droite
a la derecha

Troutman

19836-2

10,0 cm/4"

Hornhautscheren
Corneal Scissors
Ciseaux pour la corneé
Tijeras para córnea

Sehnenscheren
Tenotomy Scissors
Ciseaux à tenotomie
Tijeras para tenotomía

Hornhautscheren, Corneal Scissors, Ciseaux pour la corneé, Tijeras para córnea



links
to the left
à gauche
a la izquierda

Katzin

19820-1

10,0 cm/4"



rechts
to the right
à droite
a la derecha

Katzin

19820-2

10,0 cm/4"



links
to the left
à gauche
a la izquierda

Katzin

19821-1

10,0 cm/4"

mit Sperre
with ratchet
avec arrêt
con cierre



rechts
to the right
à droite
a la derecha

Katzin

19821-2

10,0 cm/4"

Hornhautscheren, Corneal Scissors
 Ciseaux pour la corneé, Tijeras para córnea

Sehnenscheren, Tenotomy Scissors
 Ciseaux à tenotomie, Tijeras para tenotomía



Mc Guire

19822

10,0 cm/4"



seitwärts abgewinkelt
angular on side
coude à la côté
acodada lateral

Castroviejo

19824

9,0 cm/3½"



spitz
sharp
pointus
agudos

Westcott

19883-1

11,0 cm/4½"



stumpf
blunt
mousses
romos

Westcott

19883

11,0 cm/4½"



SCHWERT
 SWORD · ESPADA
 EPEE · SPADA



SCHWERT
SWORD · ESPADA
EPEE · SPADA

Iridektomiescheren
Iridectomy Scissors
Ciseaux à iridectomie
Tijeras para iridectomía

gerade
straight
droits
rectas



19852-1
9,0 cm/3½"



19852-2
9,0 cm/3½"
gebogen
curved
courbes
curvas



19852-3
9,0 cm/3½"
kniegebogen
angular on side
coude a lt côte
acodada lateral

geknöpft
probe pointed
boutonnés
abotonadas



19853
9,0 cm/3½"



Noyes
19823
12,0 cm/4¾"



Noyes
12,0 cm/4¾"



Fig. 1
19827-1



Fig. 2
19827-2



Fig. 3
19827-3

Hornhautscheren
Corneal Scissors
Ciseaux pour la corneé
Tijeras para córnea



SCHWERT
 SWORD · ESPADA
 EPEE · SPADA



gebogen
 curved
 courbes
 curvas

Castroviejo

19842

9,0 cm/3½"



links
 to the left
 à gauche
 a la izquierda

Castroviejo

19830-2

11,0 cm/4½"



rechts
 to the right
 à droite
 a la derecha

Castroviejo

19830-1

11,0 cm/4½"



spitz
 sharp
 pointus
 agudos

Castroviejo

19838-1

10,0 cm/4"



stumpf
 blunt
 mousses
 romos

Castroviejo

19838-2

10,0 cm/4"



Mikro-Scheren
Micro Scissors
Micro-Ciseaux
Micro Tijeras

SCHWERT
 SWORD · ESPADA
 EPEE · SPADA



Reil



19860-1
 14,0 cm/5½"
 gerade
 straight
 droits
 rectas



19860-2
 15,5 cm/6¼"
 gebogen
 curved
 courbes
 curvas



19860-3
 15,5 cm/6¼"
 gebogen
 curved
 courbes
 curvas

1 Schneide gezahnt
 1 blade saw edge
 1 lame dentelée
 1 hoja dentada



Vannas
 16,0 cm/6¼"



19861-1
 gerade
 straight
 droits
 rectas



19861-2
 gebogen
 curved
 courbes
 curvas



10,0 cm/4"



19862-1
 14,0 cm/5½"
 gerade
 straight
 droits
 rectas

sehr fein
 very delicate
 très fins
 muy finos



19862-2
 15,5 cm/6¼"
 gebogen
 curved
 courbes
 curvas

spitz
 sharp
 pointus
 agudos

Mikro-Scheren
Micro Scissors
Micro-Ciseaux
Micro Tijeras



SCHWERT
 SWORD · ESPADA
 EPEE · SPADA

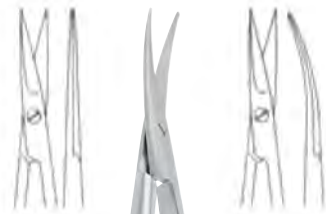

18674-18

gerade
 straight
 droits
 rectas

18675-18

gebogen
 curved
 courbes
 curvas

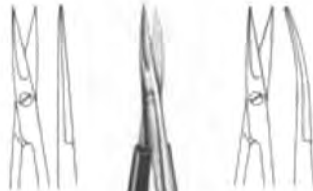

18674-15

gerade
 straight
 droits
 rectas

18675-15

gebogen
 curved
 courbes
 curvas



18674-12

gerade
 straight
 droits
 rectas

18675-12

gebogen
 curved
 courbes
 curvas



12,5 cm/5"



15,0 cm/6"



18,0 cm/7"



Irisscheren "Ribbon type"
Iris Scissors "Ribbon type"
Ciseaux pour l'iris "Ribbon type"
Tijeras para iris "Ribbon type"

SCHWERT
SWORD - ESPADA
EPEE - SPADA



spitz
sharp
pointus
agudos



19890-9	9,0 cm/3½"	19891-9
19890-10	10,5 cm/4¼"	19891-10
gerade		gebogen
straight		curved
droits		courbes
rectas		curvas



spitz
sharp
pointus
agudos



19892-9	9,5 cm/3¾"	19893-9
gerade		gebogen
straight		curved
droits		courbes
rectas		curvas



SCHWERT
SWORD · ESPADA
EPEE · SPADA

Mikrochirurgie
Microsurgery
Microchirurgie
Microcirugía





SCHWERT
SWORD · ESPADA
EPEE · SPADA

Für Klingengröße
Nr 3.
For blades size
no. 3.



13060
Edelstahl,
ergonomische Form
Stainless steel,
ergonomic shape



13061
Edelstahl, gebogen,
ergonomische Form
Stainless steel, curved
ergonomic shape

Skalpelle-Griffe Scalpel Handles Manches pour bistouris Mangos de bisturías

i

SAFE-EX 2

patented

13051

Sicherheitsklinghalter mit Abwurf Funktion,
ergonomische Form, zerlegbar
Safety blade holder with eject function,
ergonomic shape, dismountable



Das alltägliche Verletzungsrisiko beim Aufnehmen und vor allem dem Entfernen der Klinge vom Skalpell Griff ist mit herkömmlichen Instrumenten unvermeidlich. Mit dem neuen SCHWERT SAFE-EX hat man eine Innovation geschaffen die den Praxisalltag verändert.

Die im Griff integrierte Funktion, ähnlich der Benutzung eines Kugelschreibers, reduziert die Verletzungsgefahr auf ein Minimum. Die Klinge wird beim SAFE-EX per Knopfdruck am distalen Ende einfach ausgeworfen. Praxispersonal wird im Zuge der Wiederaufbereitung wirksam vor Krankheitsübertragungen und Infektionen durch Schnitte geschützt.

The daily risk of injuries by mounting and especially dismantling of blades is not avoidable by standard blade holders. With the new SCHWERT SAFE-EX an innovation was developed that changes the daily routine eminently.

The integrated function that works like a regular ball pen reduces the risk of an injury to a minimum. The blade is ejected from the SAFE-EX just by pushing the button on the distal end. The practice staff, especially during the re-processing, is safe from infections caused by unintended cuts.



1:1

Für Mikroklingen
For micro blades.



13070
Ergonomisch, Titan
Ergonomic, titanium

Mikro-Pinzetten
Micro Forceps
Micro-Pinces
Micro Pinzas



SCHWERT
 SWORD · ESPADA
 EPEE · SPADA

1:1

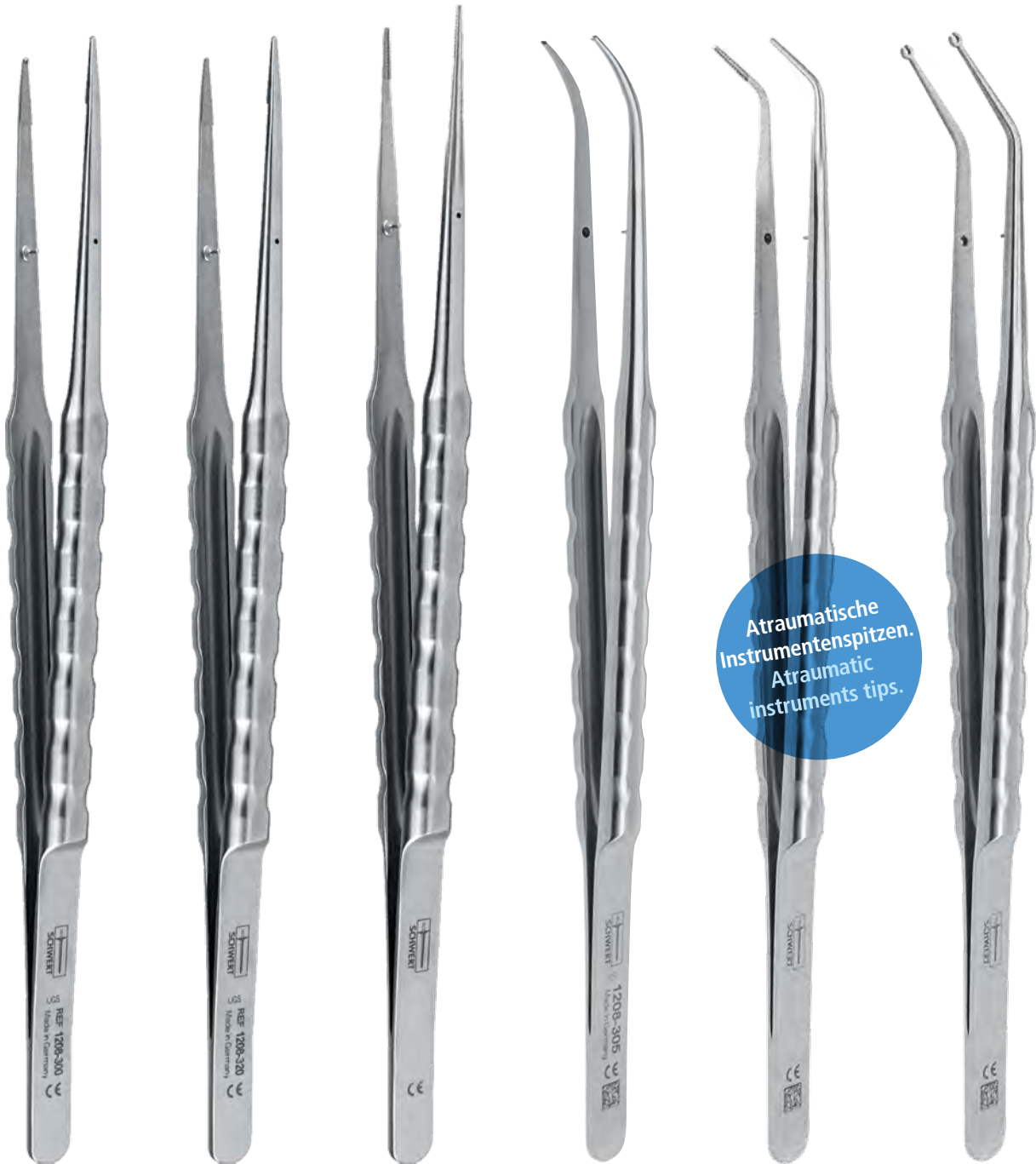
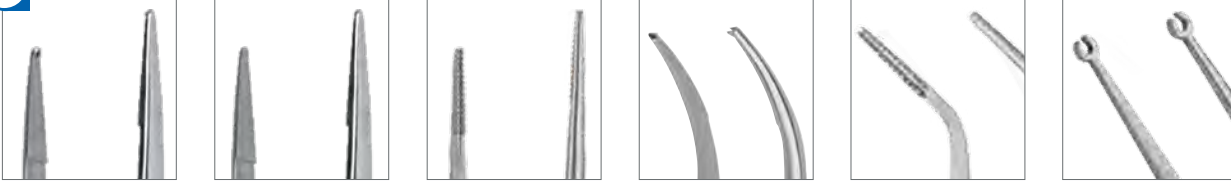

Atraumatische
 Instrumentenspitzen.
 Atraumatic
 instruments tips.

11407-30

1x2 Zähne
 1x2 teeth
 17,5 cm

mit Fadenplatte
 with suture plate

11407-32

glatt
 smooth
 17,5 cm

mit Fadenplatte
 with suture plate

11407-34

COOLEY
 17,5 cm

11407-305

1x2 Zähne
 1x2 teeth
 17,5 cm

mit Fadenplatte
 with suture plate

11407-345

COOLEY
 17,5 cm

11407-355

Ø Ring: 2,0 mm
 Ø ring: 2.0 mm
 17,5 cm

Mikro Nahtpinzette
 Micro suture forceps





SCHWERT
SWORD · ESPADA
EPEE · SPADA

Nadelhalter
Needle Holders
Porte-aiguilles
Porta-agujas

i

SCHWERT *twist* Serie
SCHWERT *twist* series

Die SCHWERT *twist* Instrumente mit gedrehtem Schluss vermeiden zuverlässig ein Verfangen des Fadens während des Knüpfens.

The SCHWERT *twist* instruments with the twisted lock avoid reliably sticking of the suture while knotting.

1:1



12360-10

***twist* TC**

Mikro Nadelhalter
mit Schloss, 17,5 cm
Micro Needleholder
with lock, 17.5 cm

5/0 - 8/0

Fadenstärke
suture size



12360-16

***twist* TC**

Mikro Nadelhalter
mit Schloss, 17,5 cm
Micro Needleholder
with lock, 17.5 cm

5/0 - 8/0



12360-60

***twist* TC**

Mikro Nadelhalter
mit Schloss, 17,5 cm
Micro Needleholder
with lock, 17.5 cm

4/0 - 8/0

12360-66

***twist* TC**

Mikro Nadelhalter
mit Schloss, 17,5 cm
Micro Needleholder
with lock, 17.5 cm



**Nadelhalter
Needle Holders
Porte-aiguilles
Porta-agujas**

1:1



SCHWERT
SWORD · ESPADA
EPEE · SPADA



12360-61

twist TC

Mikro Nadelhalter
mit Schloss, 15,0 cm
Micro Needleholder
with lock, 15.0 cm

4/0 - 8/0



12360-67

twist TC

Mikro Nadelhalter
mit Schloss, 15,0 cm
Micro Needleholder
with lock, 15.0 cm

4/0 - 8/0



12360-70

twist TC

Mikro Nadelhalter
nach Kirsch
mit Schloss, 17,5 cm
Micro Needleholder
acc. to Kirsch
with lock, 17.5 cm

4/0 - 8/0

Fadenstärke
suture size



SCHWERT
SWORD · ESPADA
EPEE · SPADA

Mikro-Scheren
Micro Scissors
Micro-Ciseaux
Micro Tijeras



18675-17

MICRO
17,5 cm
Ø 8,0 mm
gebogen, fein
curved, fine



18675-217

MICRO
17,5 cm
Ø 8,0 mm
gebogen, sehr fein
curved, very fine



18675-117

MICRO
17,5 cm
Ø 8,0 mm
mikroverzahnt, gebogen
micro serrated, curved

1:1



SCHWERT
SWORD · ESPADA
EPEE · SPADA

HNO-Instrumente ENT-Instruments Instruments ORL Instrumental ORL

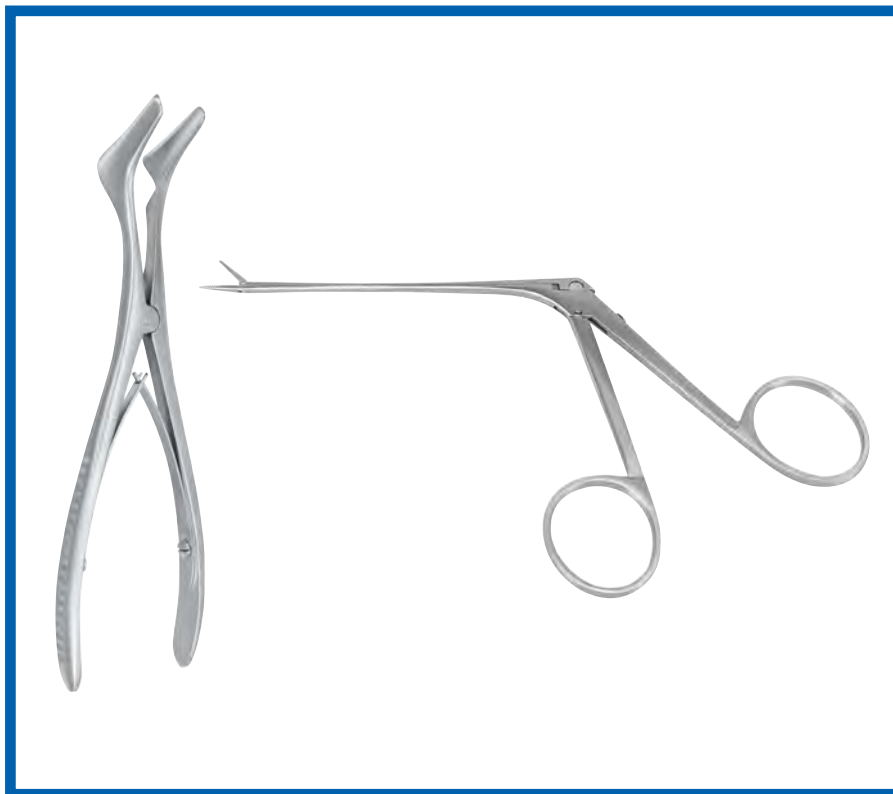



SCHWERT
SWORD · ESPADA
EPEE · SPADA

Scharfe Nasenzangen
Nasal Cutting Forceps
Pinces coupantes pour le nez
Pinzas cortantes para la nariz

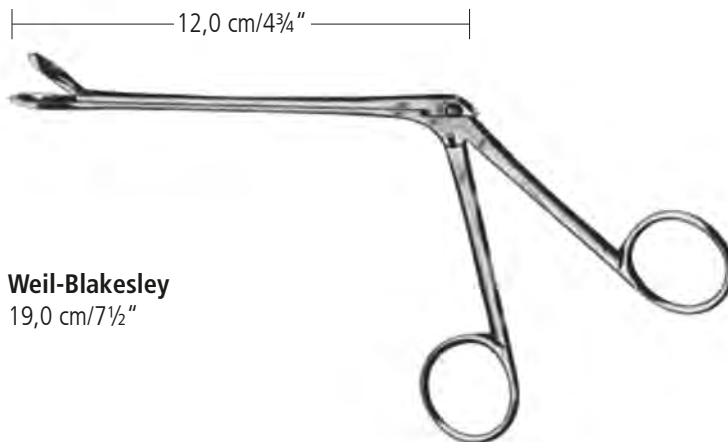

Weil-Blakesley
19,0 cm / 7 1/2"

	gerade straight droits rectas	Standard	mit Absaugrohr with suction tube avec tube d'aspiration con tubo de aspiración
1/1			
	2,5 mm	21198-V1	21199-V1
	3,6 mm	21198-V2	21199-V2
	4,8 mm	21198-V3	
	5,3 mm	21198-V4	
	6,3 mm	21198-V5	

	45° aufgebogen 45° curved upwards 45° courbe en haut 45° curva arriba	Standard	mit Absaugrohr with suction tube avec tube d'aspiration con tubo de aspiración
1/1			
	2,5 mm	21198-V11	21199-V11
	3,6 mm	21198-V12	21199-V12
	4,8 mm	21198-V13	
	5,3 mm	21198-V14	
	6,3 mm	21198-V15	

	90° aufgebogen 90° curved upwards 90° courbe en haut 90° curva arriba	Standard
1/1		
	2,5 mm	21198-V21
	3,6 mm	21198-V22
	4,8 mm	21198-V23
	5,3 mm	21198-V24

Scharfe Nasenzangen
 Nasal Cutting Forceps
 Pincas coupantes pour le nez
 Pinzas cortantes para la nariz



SCHWERT
 SWORD · ESPADA
 EPEE · SPADA



Takahashi
 19,0 cm / 7 1/2 inches

 	gerade straight droits rectas	Standard	mit Absaugrohr with suction tube avec tube d'aspiration con tubo de aspiración
	Fig. 1 2,5 mm	21198-L1	21199-L1
	Fig. 2 4,0 mm	21198-L2	21199-L2

 	45° aufgebogen 45° curved upwards 45° courbe en haut 45° curva arriba	Standard	mit Absaugrohr with suction tube avec tube d'aspiration con tubo de aspiración
	Fig. 1 2,5 mm	21198-L11	21199-L11
	Fig. 2 4,0 mm	21198-L12	21199-L12



SCHWERT
SWORD · ESPADA
EPEE · SPADA

Nasenzangen (Doppellöffel)
Nasal Forceps (Biopsy Forceps)
Pincès pour le nez (Pincès emporte-pièce à biopsie)
Pinzas para la nariz (Pinzas para biopsia)

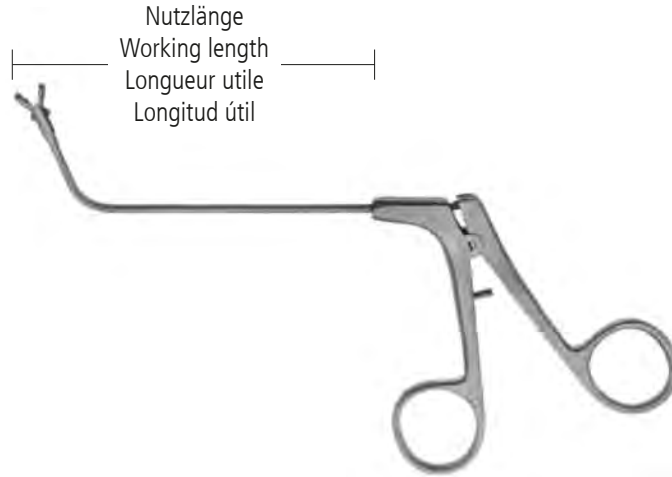

21205-1

gerade
straight
droits
rectas

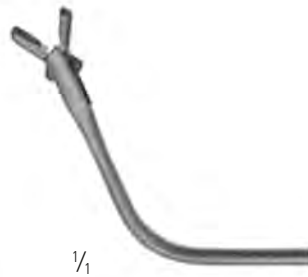

21205-11

70° aufgebogen
70° curved upwards
70° courbe en haut
70° curva arriba



21205-21

90° aufgebogen
90° curved upwards
90° courbe en haut
90° curva arriba

	Maul Jaw Mors Boca	Nutzlänge Working length Longueur utile Longitud útil
21205-1	3x4,5 mm	110 mm
21205-11	3x4,5 mm	80 mm
21205-21	3x4,5 mm	70 mm

Nasenzangen (durchschneidend)
Punch Forceps (cutting)
Pincés coupantes pour le nez
Pinzas cortantes para la nariz



SCHWERT
 SWORD · ESPADA
 EPEE · SPADA

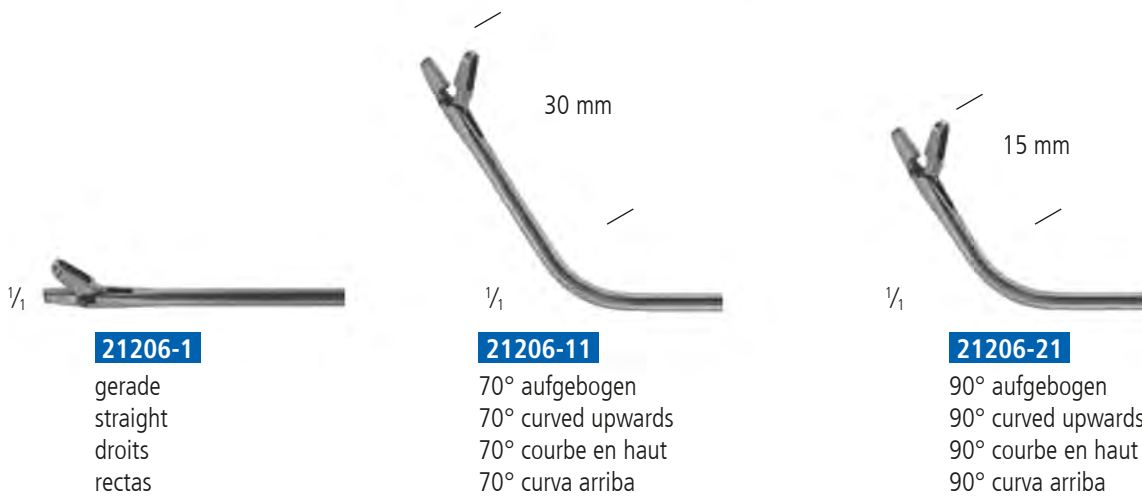
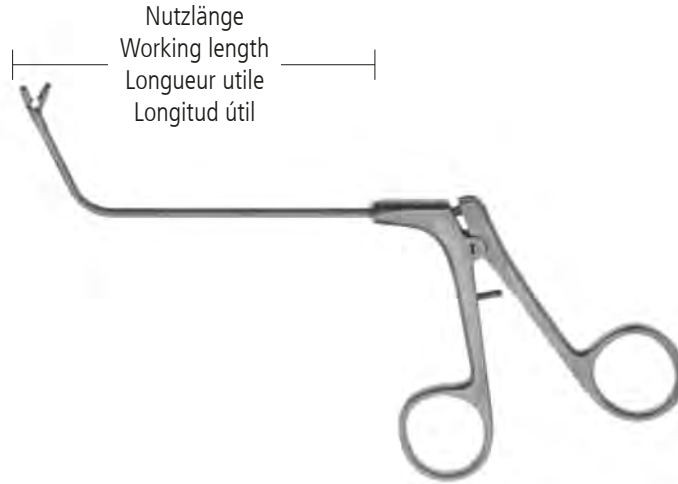

	Maul Jaw Mors Boca	Nutzlänge Working length Longueur utile Longitud útil
21206-1	1,5x5 mm	110 mm
21206-11	1,5x5 mm	80 mm
21206-21	1,5x5 mm	70 mm



SCHWERT
SWORD - ESPADA
EPEE - SPADA

Scharfe Nasenzangen
Nasal Cutting Forceps
Pincès coupantes pour le nez
Pinzas cortantes para la nariz

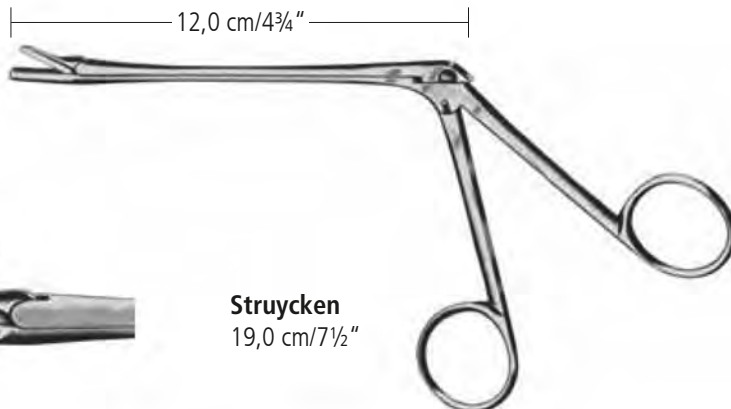

21198-D

1,0 mm





Struycken
19,0 cm / 7 1/2 inches

21198-D1,5

1,0 mm

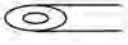

Wilde

	Bissbreite Width of bite Grandeur de coupe Ancho de la boca	Schaftlänge, Length of shaft Longueur de tige, Largo del asta		Schaftlänge, Length of shaft Longueur de tige, Largo del asta	
		13,0 cm / 5"	17,0 cm / 6 3/4"	13,0 cm / 5"	17,0 cm / 6 3/4"
	3x8 mm	21201-3	21202-3	21201-13	21202-13
	4x10 mm	21201-4	21202-4	21201-14	21202-14

Nasenscheren
Nasal Scissors
Ciseaux pour le nez
Tijeras nasales



SCHWERT
 SWORD · ESPADA
 EPEE · SPADA



— 14 mm —

1/1



21258-1

gerade
 straight
 droits
 rectas

1 Schneide gezahnt
 1 blade toothed
 1 tranchant dentelé
 1 filo dentado



— 14 mm —

1/1



21258-2

rechts gebogen
 curved to the right
 courbe à droite
 curva hacia la derecha

1 Schneide gezahnt
 1 blade toothed
 1 tranchant dentelé
 1 filo dentado



— 14 mm —

1/1



21258-3

links gebogen
 curved to the left,
 courbe à gauche
 curva hacia la izquierda

1 Schneide gezahnt
 1 blade toothed
 1 tranchant dentelé
 1 filo dentado



Septumscheren
Septum Scissors
Ciseaux pour la cloison nasale
Tijeras para el tabique nasal

SCHWERT
SWORD · ESPADA
EPEE · SPADA

gezahnt
toothed
dentele
dentado



Caplan
20,0 cm/8"

21255-20

gezahnt
toothed
dentele
dentado



Killian
21,0 cm/8½"

21256-20

Septumzangen
Septum Forceps
Pincès pour la cloison nasale
Pinzas para el tabique nasal



SCHWERT
SWORD · ESPADA
EPEE · SPADA



Rubin
21,0 cm/8½"
21264

TC-Rubin
21,0 cm/8½"
21264-TC



Asch
22,0 cm/8¾"
21268



Nasenspekula
Nasal Specula
Spéculums pour le nez
Espéculos nasales

SCHWERT
SWORD · ESPADA
EPEE · SPADA



Hartmann
16,5 cm/6½"

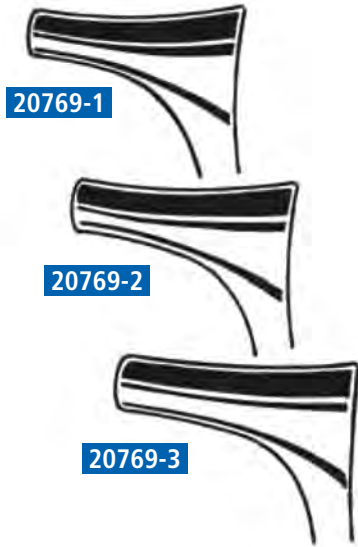

Hartmann-Halle
15,0 cm/6"

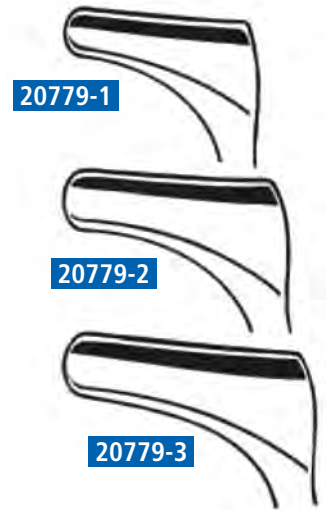

Tieck-Halle
13,5 cm/5¼"
20782-1



Nasenspekula
 Nasal Specula
 Spéculum pour le nez
 Espéculos nasales



SCHWERT
 SWORD · ESPADA
 EPEE · SPADA

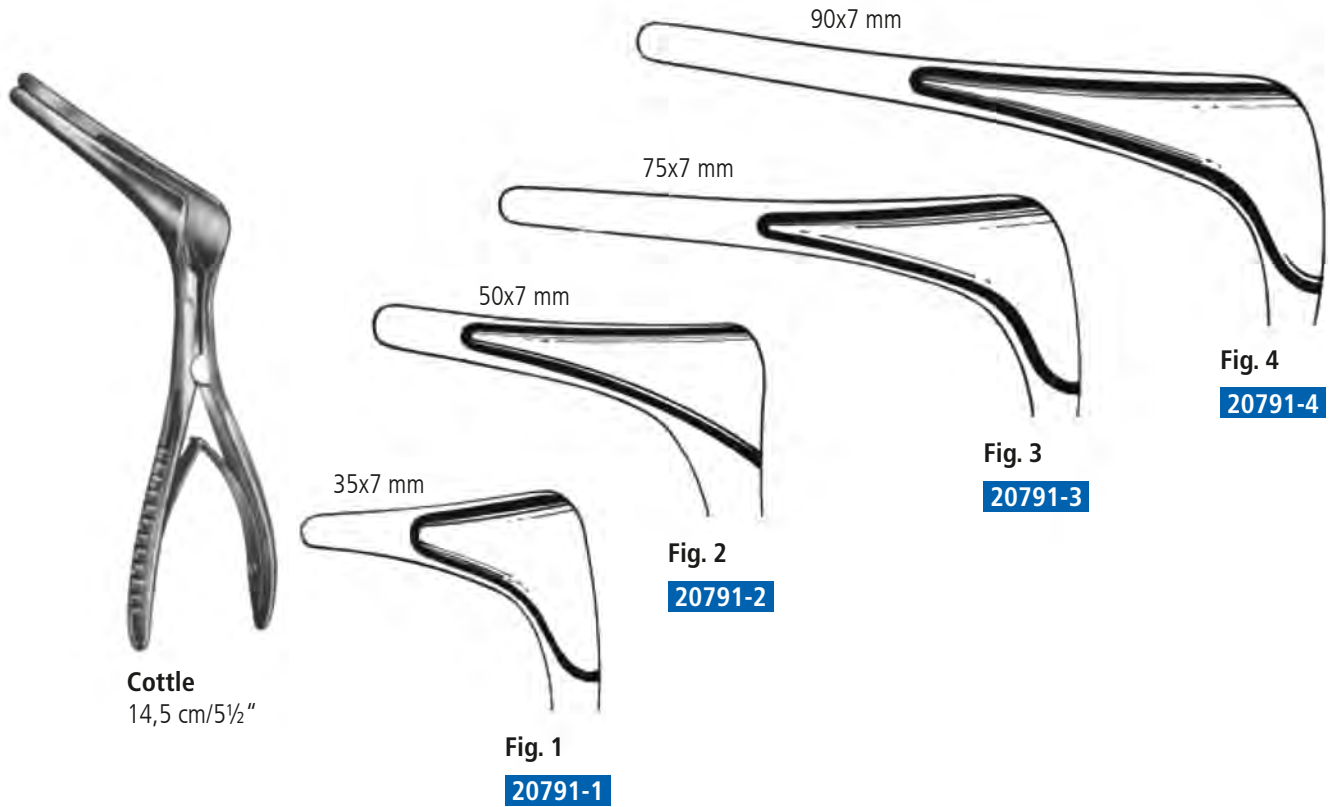

Cottle
 14,5 cm/5½"

Fig. 1
 20791-1

Fig. 2
 20791-2

Fig. 3
 20791-3

Fig. 4
 20791-4

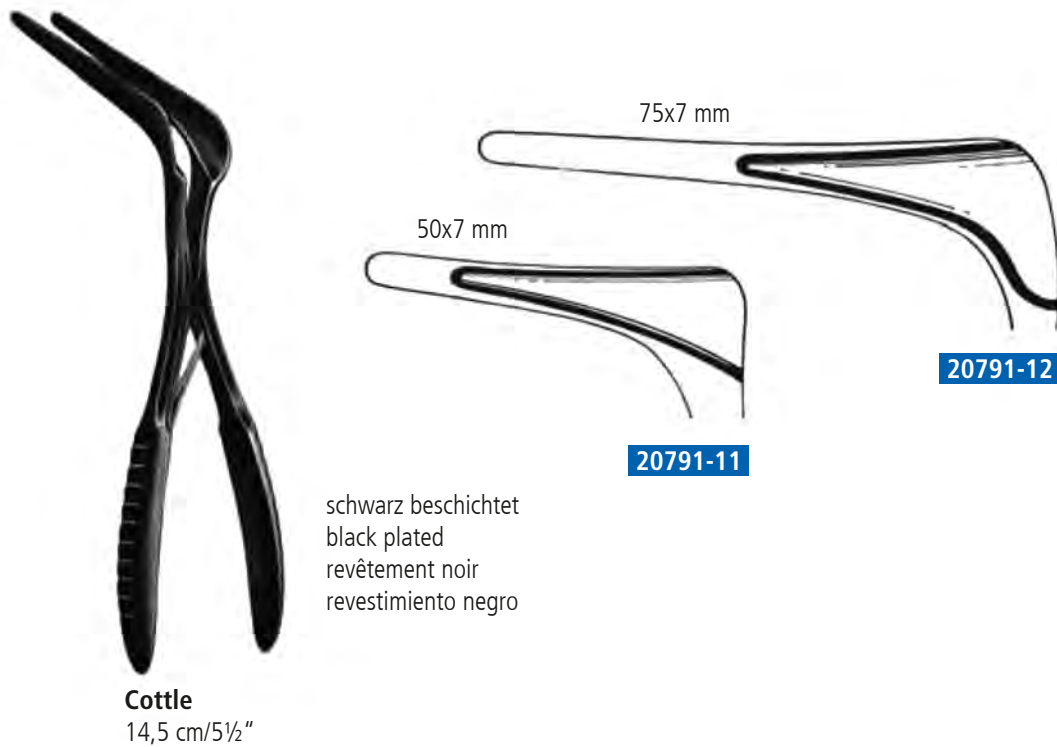

Cottle
 14,5 cm/5½"

schwarz beschichtet
 black plated
 revêtement noir
 revestimiento negro

20791-11

20791-12



SCHWERT
SWORD · ESPADA
EPEE · SPADA

**Nasenspekula
Nasal Specula
Spéculums pour le nez
Espéculos nasales**



Killian
13,0 cm/5"

20790-1

35 mm

20790-2

50 mm

20790-3

75 mm

20790-4

90 mm



Modell Wien
14,0 cm/5½"

Fig. 1

20785-1



Fig. 2

20785-2



Fig. 3

20785-3



Thudichum (Goldsmith)
6,5 cm/2½"



Fig. 1

20748-1



Fig. 2

20748-2



Fig. 3

20748-3



Fig. 4

20748-4



Fig. 5

20748-5

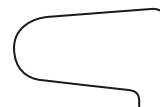

Fig. 6

20748-6

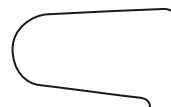

Fig. 7

20748-7

Polypenschnürer
Nasal Polypus Snares
Serre-noeds pour polypes
Polipótomos nasales



SCHWERT
SWORD · ESPADA
EPEE · SPADA



Krause
26,0 cm/10¼"

20930



SCHWERT
SWORD - ESPADA
EPEE - SPADA

Polypenzangen
Nasal Polypus Forceps
Pinces à polypes nasaux
Pinzas para pólipos nasales



Hartmann

21039-13 13,0 cm/5"
21039-16 16,0 cm/6¼"



Hartmann

21039-20 20,0 cm/8"



Heymann-Knight

21040 18,0 cm/7"



Littauer

21041 18,0 cm/7"

Nasen- und Ohrpinzetten
 Nasal and Ear Dressing Forceps
 Pincés nasales et auriculaires
 Pinzas nasales y auriculares



SCHWERT
 SWORD · ESPADA
 EPEE · SPADA



Troeltsch (Wilde)

- 20331-11** 11,0 cm/4½"
- 20331** 12,0 cm/4¾"
- 20955** 15,0 cm/6"
- 20957** 18,0 cm/7"



bajonettförmig
 bayonet-shaped
 en forme de baïonette
 en forma de bayoneta

Jansen

- 20950** 16,0 cm/6½"
- 20950-18** 18,0 cm/7"

Grünwald-Jansen

- 20952** 20,0 cm/8"



Lucae

- 20326** 14,0 cm/5½"



Lucae 1 x 2

- 20327** 14,0 cm/5½"



Cottle

- 20328** 14,0 cm/5½"



SCHWERT
SWORD · ESPADA
EPEE · SPADA

Nasenzangen
Nasal Forceps
Pinces pour le nez
Pinzas para la nariz

Septumzangen
Septum Forceps
Pinces pour la cloison nasale
Pinzas para el tabique nasal



Westmacott

21052 20,0 cm/8"



Graig

21100 18,0 cm/7"

Nasen-Septumzange
Nasal Septum Forceps
Pinces pour la cloison nasale
Pinzas para el tabique nasal

Septumzangen
Septum Forceps
Pince pour la cloison nasale
Pinza para el tabique nasal



Killian

21086 17,0 cm/6¾"



Knight

21090 18,0 cm/7"

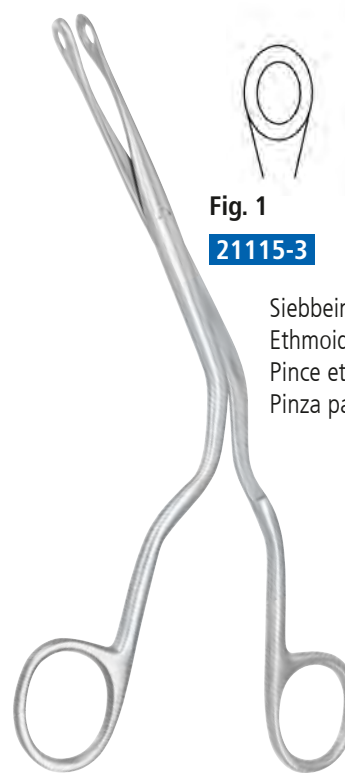

Luc

20,0 cm/8"

Fig. 1

21115-3

Fig. 2

21115-4

Siebbeinzange
Ethmoid Forceps
Pince ethmoidales
Pinza para etmoides

Septumzangen
Septum Forceps
Pincers pour la cloison nasale
Pinzas para el tabique nasal



SCHWERT
SWORD · ESPADA
EPEE · SPADA



durchschneidend
through-cutting
coupantes des deux côtés
bocas cortantes la una en la otra

Middleton-Jansen

21144

19,0 cm/7½"



Löffelmaul
spoon-shaped jaw
mors en forme d'un cuiller
con boca en forma de cucharilla

Middleton-Jansen

21143

19,0 cm/7½"



Keilbeinstanzen
Sphenoid Punches
Pinces emporte-pièces pour sinus sphénoïdal
Pinzas cortantes para seno esfenoïdal

SCHWERT
SWORD · ESPADA
EPEE · SPADA

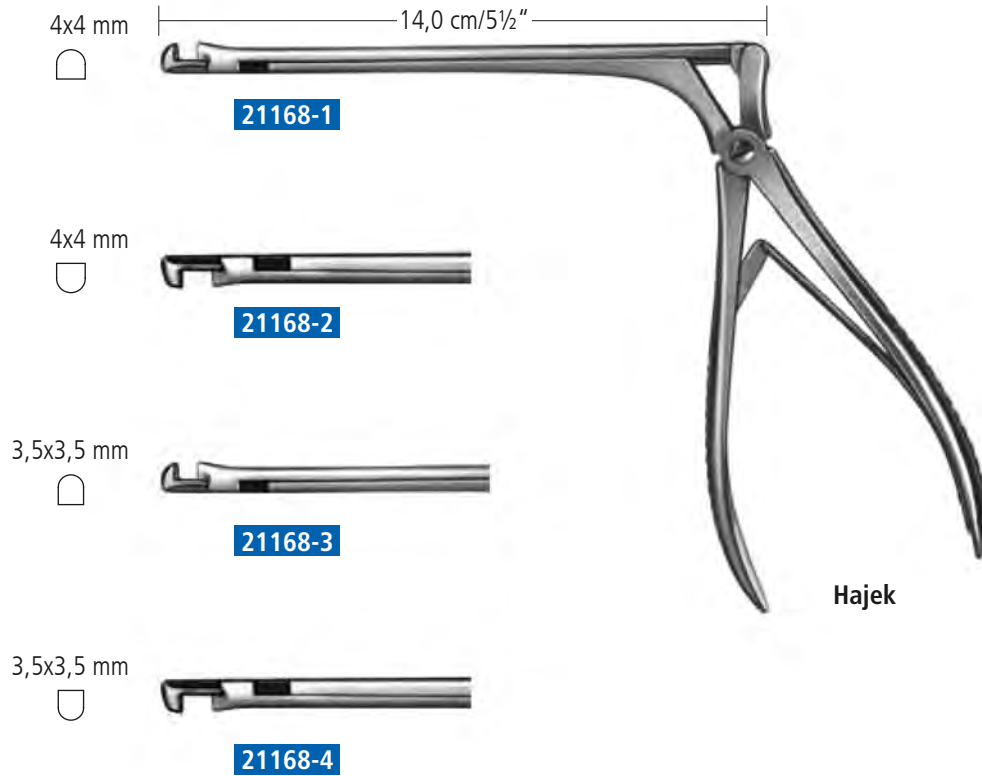

Kieferhöhlenstanze
Antrum Punch Forceps
Pinces emporte-pièces pour sinus maxillaire
Pinzas cortantes para seno maxila



4 mm

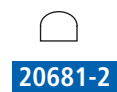

5 mm



6 mm



Septum-Elevatorien
Septum Elevators
Elévateurs pour la cloison nasale
Elevadores para el tabique nasal



SCHWERT
 SWORD · ESPADA
 EPEE · SPADA



scharf
 sharp
 tranchant
 cortante

Freer

21421-1

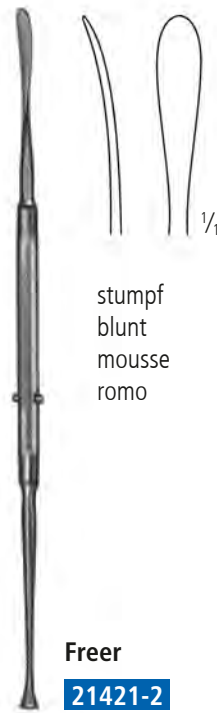

stumpf
 blunt
 mousse
 romo

Freer

21421-2

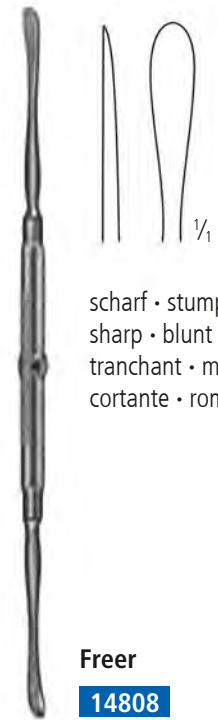

scharf · stumpf
 sharp · blunt
 tranchant · mousse
 cortante · romo

Freer

14808

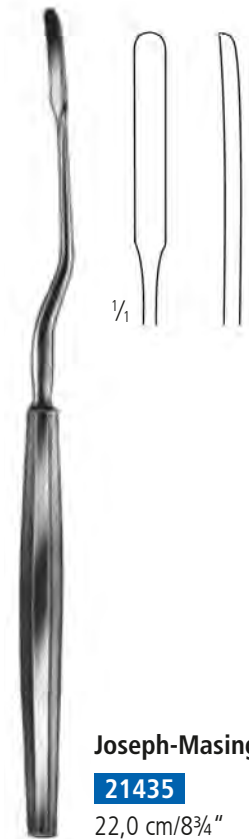

Joseph-Masing

21435

22,0 cm/8³/₄"



Killian

21402

18,0 cm/7"



Kürette
 Curette
 Curette tranchante
 Cucharilla cortante

Faulkner

21465

21,0 cm/8¹/₄"

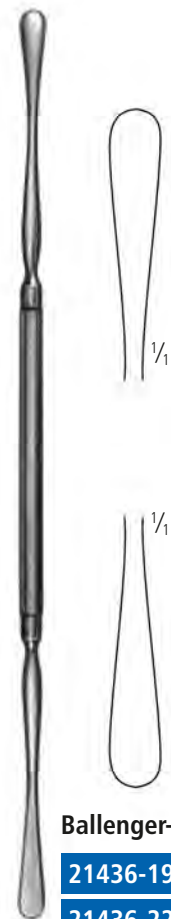

Ballenger-Hajek

21436-19

19,0 cm/7¹/₂"

21436-22

22,0 cm/8³/₄"



SCHWERT
SWORD · ESPADA
EPEE · SPADA

Septum- und Periost-Elevatoren
Septum and Periosteal Elevators
Élévateurs pour la cloison et le périoste
Elevadores para el tabique nasal y para el periostio



Killian
21422
18,0 cm/7"

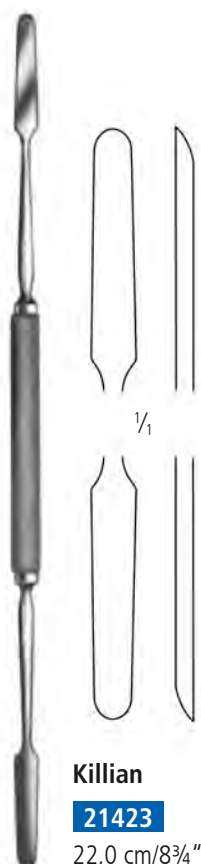

Killian
21423
22,0 cm/8¾"

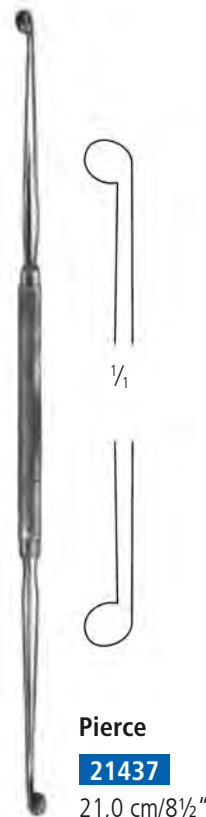

Pierce
21437
21,0 cm/8½"

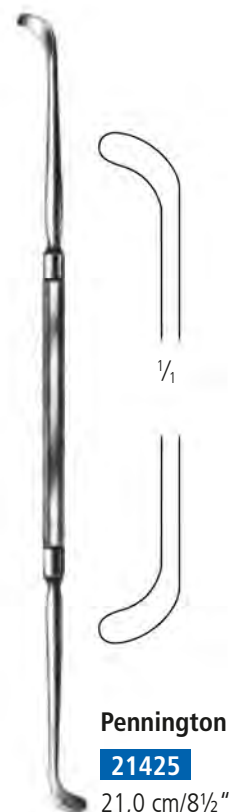

Pennington
21425
21,0 cm/8½"

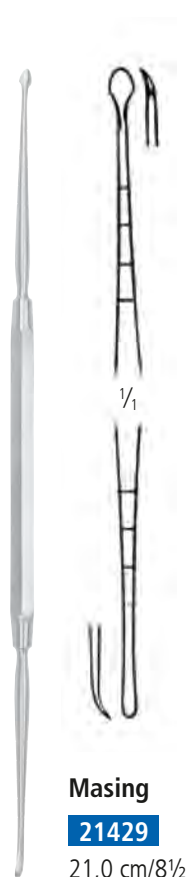

Masing
21429
21,0 cm/8½"

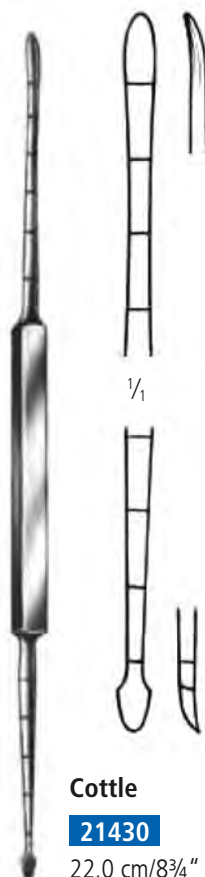

Cottle
21430
22,0 cm/8¾"

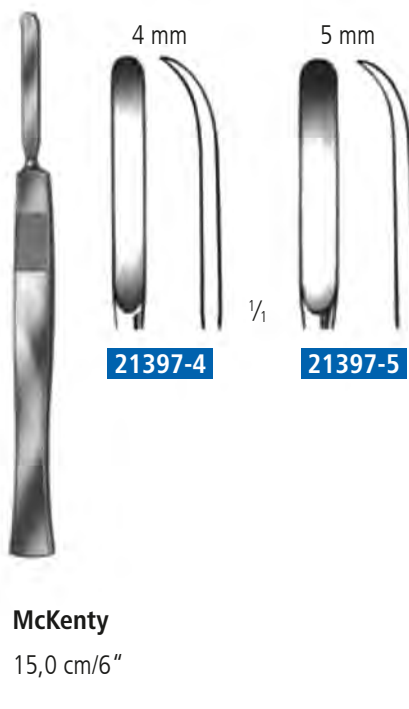

McKenty
15,0 cm/6"

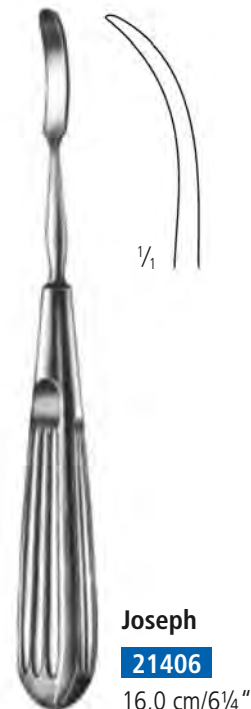

Joseph
21406
16,0 cm/6¼"

Nasen-Osteotome
 Nasal Osteotomes
 Osteotomes nasales
 Osteotomos nasales



SCHWERT
 SWORD · ESPADA
 EPEE · SPADA

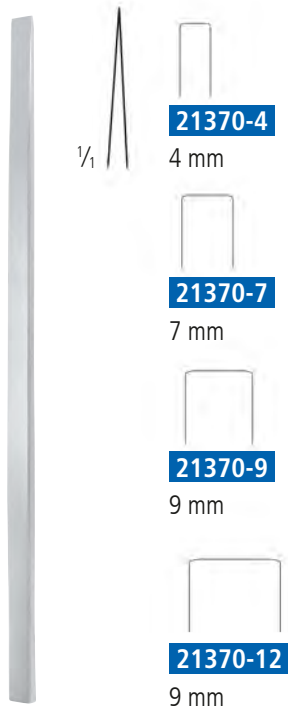

Cottle
 18,0 cm/7"

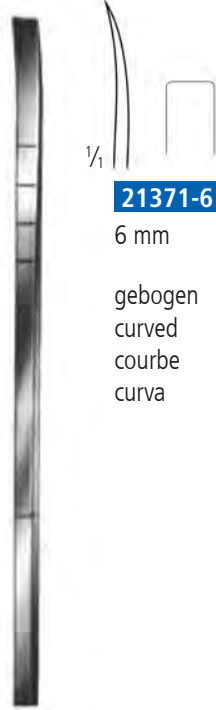

Cottle
 18,0 cm/7"

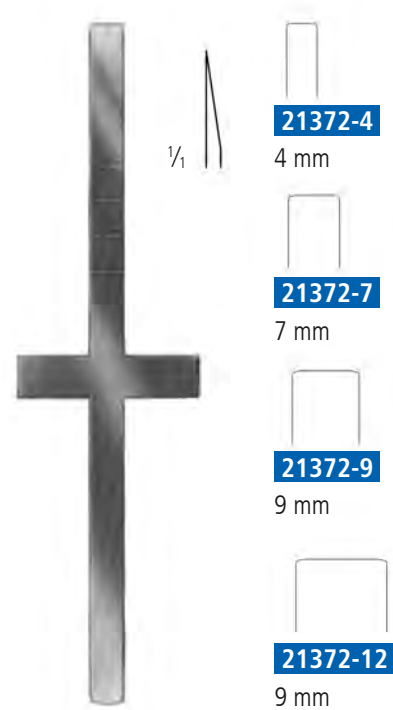

Cottle
 18,0 cm/7"

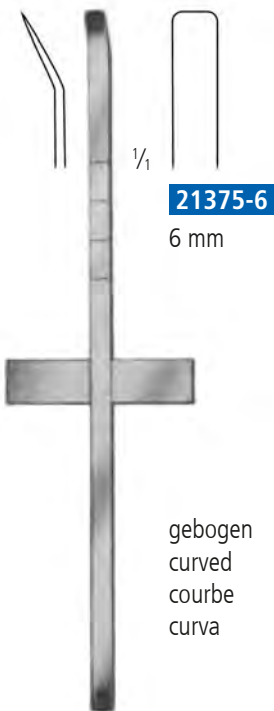

Cottle
 18,0 cm/7"

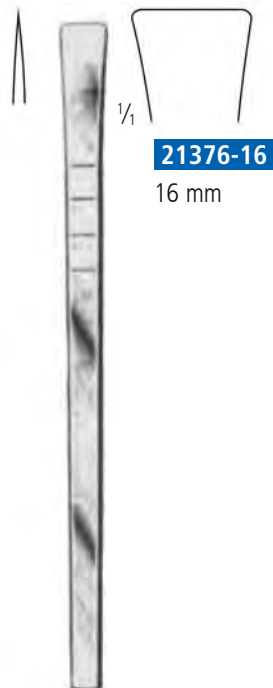

Cottle
 18,0 cm/7"

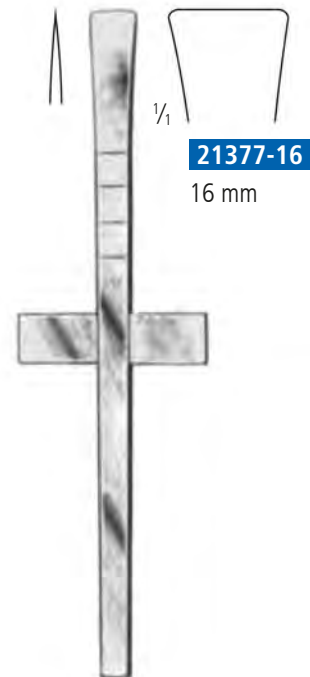

Cottle
 18,0 cm/7"



SCHWERT
SWORD · ESPADA
EPEE · SPADA

Nasen-Osteotome
Nasal Osteotomes
Osteotomes nasales
Osteotomos nasales

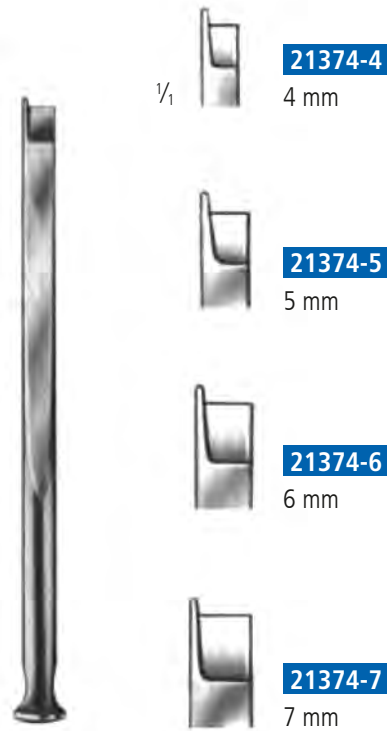

Fomon
17,0 cm/6¾"

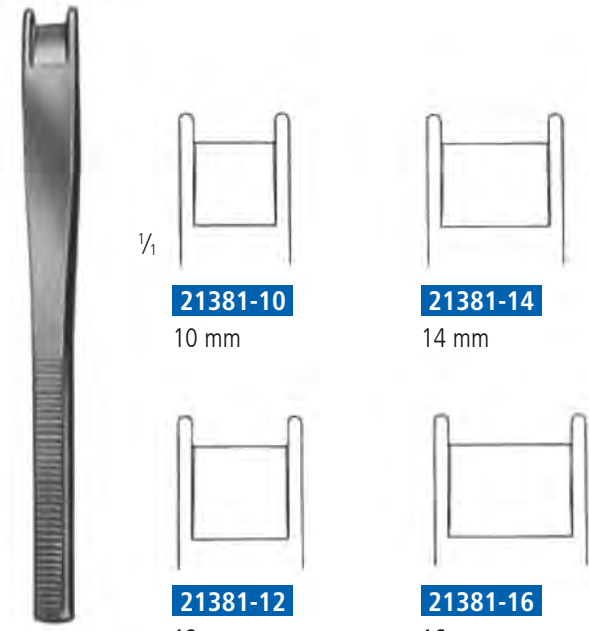

Cinelli
16,0 cm/6½"

Flachmeißel
Chisel
Ciseaux-burin
Cinzel

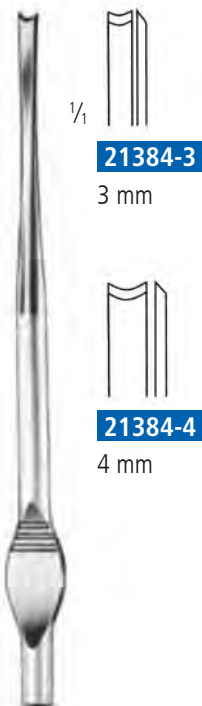

Walter
19,0 cm/7¾"

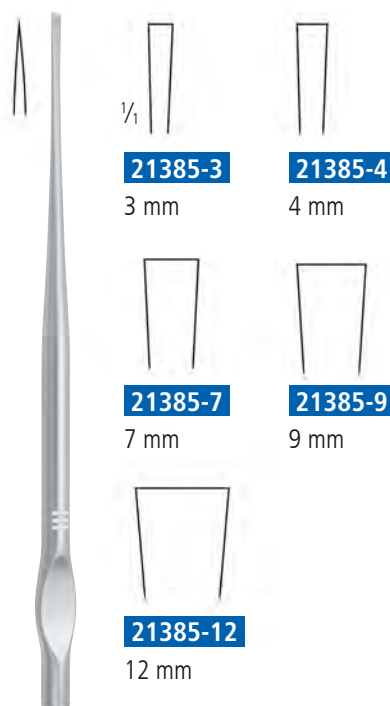

Walter
19,0 cm/7¾"

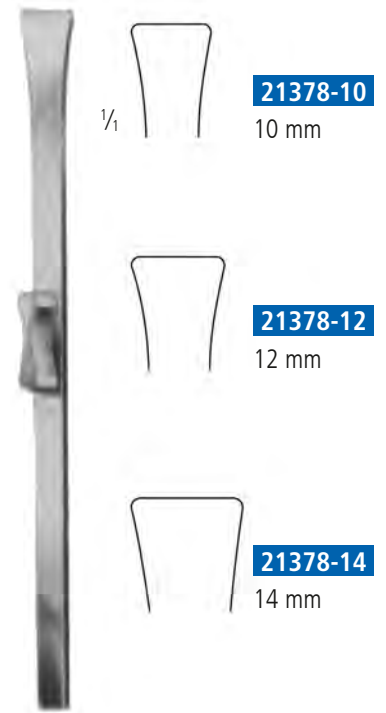

Rubin
18,0 cm/7"

Nasen-Osteotome
Nasal Osteotomes
Osteotomes nasales
Osteotomos nasales



gerade
 straight
 droit
 recto

Silver

21383-1

18,0 cm/7"

Flachmeißel
Chisels
Ciseaux-burins
Cinceles



rechts
 right
 à droite
 a la derecha

Silver

21383-2

18,0 cm/7"

Septum-Hohlmeißel
Septum Gouges
Septum gouges
Septum gubias



links
 left
 à gauche
 a la izquierda

Silver

21383-3

18,0 cm/7"



SCHWERT
 SWORD · ESPADA
 EPEE · SPADA

Flachmeißel, Chisel
Ciseaux-burins, Cinceles

4 mm



gerade
 straight
 droit
 recto

Freer

21358-4

16,0 cm/6½"

4 mm



gebogen
 curved
 courbe
 curvo

Freer

21362-4

16,0 cm/6½"

6 mm



Freer

21340-2

15,0 cm/6"

Septum-Hohlmeißel, Septum Gouges, Septum gouges, Septum gubias

5 mm



Killian

21344

17,0 cm/6¾"

5 mm



Killian-Claus

21345

17,0 cm/6¾"



SCHWERT
SWORD · ESPADA
EPEE · SPADA

Nasensägen Nasal Saws Scies nasales Sierras nasales



Joseph
19,0 cm/7½"



Fig. 1
21487-10



Fig. 2
21487-11



Fig. 3
21487-12

bajonettförmig
bayonet-shaped
en forme de baïonnette
en forma de bayoneta

Nasenraspeln
Nasal Rasps
Râpes nasales
Raspas nasales



SCHWERT
SWORD · ESPADA
EPEE · SPADA

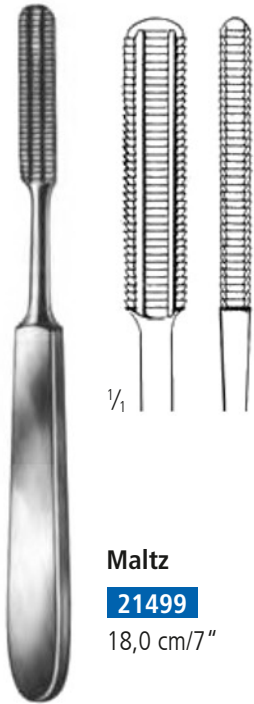

Maltz
21499
18,0 cm/7"

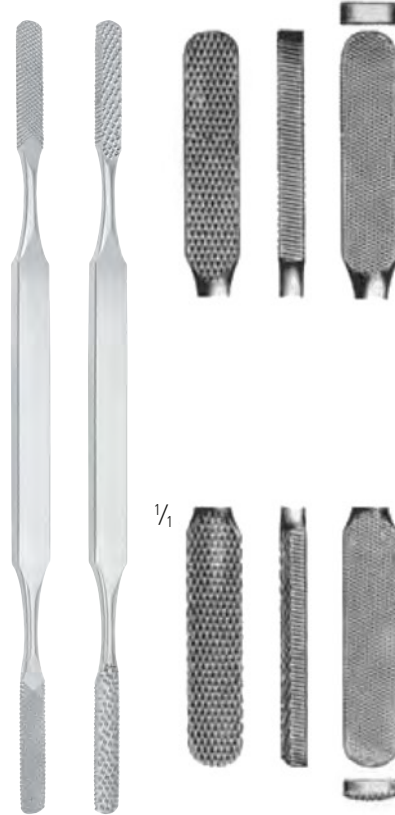

Fomon
21493
21,0 cm/8¼"

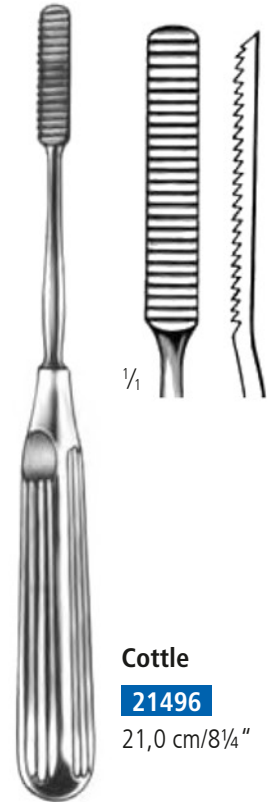

Cottle
21496
21,0 cm/8¼"

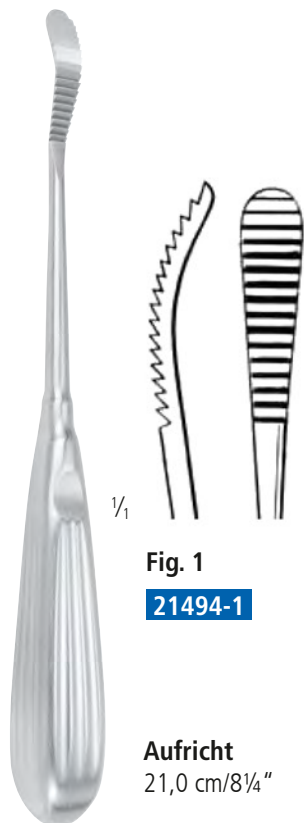

Fig. 1
21494-1

Aufricht
21,0 cm/8¼"

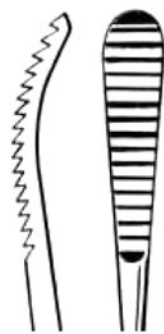

Fig. 2
21494-2

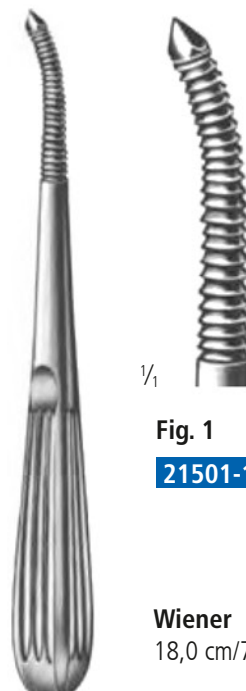

Fig. 1
21501-1

Wiener
18,0 cm/7"



Fig. 2
21501-2



SCHWERT
SWORD · ESPADA
EPEE · SPADA

Nasenflügelhaken
Hooks for posterior nares
Crochets pour les ailes du nez
Separadores nasales



$\frac{1}{4}$
Fig. 1
21515-1

Fig. 2
21515-2

Fig. 3
21515-3



Joseph
21516
15,0 cm/6"



Cottle
21518
16,0 cm/6 $\frac{1}{4}$ "



Choanenhaken
Hook for posterior nares
Crochet boutoné pour les ailes du nez
Gancho para las coanas
Cottle
21519
22,0 cm/8 $\frac{3}{4}$ "



Aufricht
21525
17,0 cm/6 $\frac{3}{4}$ "



Aufricht
21532-19
19,0 cm/7 $\frac{1}{2}$ "



Aufricht
21533
13,5 cm/5 $\frac{1}{4}$ "



Kilner
21534
10,0 cm/4"



Converse
21535
12,0 cm/4 $\frac{3}{4}$ "

Nasenflügelhaken
 Hooks for posterior nares
 Crochets pour les ailes du nez
 Separadores nasales



SCHWERT
 SWORD · ESPADA
 EPEE · SPADA



Freer
21536
 15,0 cm/6"



Joseph
 16,0 cm/6½"

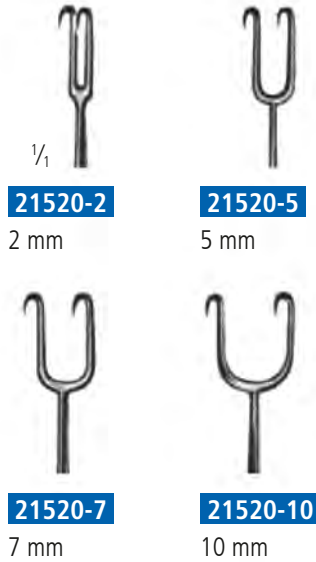

Fomon
21522
 16,0 cm/6¼"



Cottle-Neivert
21524
 20,0 cm/8"



Cottle
 15,0 cm/6"





SCHWERT
SWORD · ESPADA
EPEE · SPADA

Nasenflügelhaken
Hooks for posterior nares
Crochets pour les ailes du nez
Separadores nasales

Schwingmesser
Swivel Knives
Couteaux nasales
Cuchillos para el tabique nasal



Cottle
21537
14,0 cm/5½"



Neivert
21538
20,5 cm/8"



Cottle
21539
15,0 cm/6"



Cottle
21540
15,0 cm/6"



Ballenger
20,0 cm/8"



21317-0
3 mm



21317-1
4 mm



21317-2
5 mm

gerade
straight
droit
recto



Ballenger
22,0 cm/8½"



21319-0
3 mm



21319-1
4 mm



21319-2
5 mm

bajonettförmig
bayonet-shaped
en forme de baïonnette
en forma de bayoneta



Nasenplastik-Messer
 Rhinoplastic and Nasal Knives
 Bistouris pour plastique et le nez
 Bisturías para plástica y la nariz



SCHWERT
 SWORD · ESPADA
 EPEE · SPADA



Joseph
 15,0 cm/6"



1/1

Fig. 1

21292-1



Fig. 2

21292-3



Fomon
21301
 16,0 cm/6¼"



Cottle
21302
 15,0 cm/6"



Joseph
21303
 15,0 cm/6"



Cottle
21304
 15,0 cm/6"



SCHWERT
SWORD - ESPADA
EPEE - SPADA

**Ringmesser
Adenoid Currettes
Couteaux à végétations adénoïdes
Cuchillas para vegetaciones adenoides**



Vogel

21541

21,0 cm/8¼"



Beckmann

22,0 cm/8¾"

1/1



Fig. 1

21544-1

Fig. 2

21544-2

Fig. 3

21544-3

Fig. 4

21544-4

Fig. 5

21544-5



Barnhill

21,0 cm/8¼"



1/1

Fig. 1

21546-1

Fig. 2

21546-2

Fig. 3

21546-3

Fig. 4

21546-4



St. Clair-Thomson

21,0 cm/8¼"



1/1

Fig. 1

21557-1

Fig. 2

21557-2

Fig. 3

21557-3

Fig. 4

21557-4

Adenotome
Adenotomes
Adénotomes
Adenótomos



SCHWERT
SWORD · ESPADA
EPEE · SPADA



Beckmann
25,0 cm/10"



Fig. 1



Fig. 2



Fig. 3

1/4

mit gelochter Klinge
with perforated blade
à lame perforée
con hoja perforada

Fig. 1 21570-1

Fig. 2 21570-2

Fig. 3 21570-3

mit gelochter Klinge
with perforated blade
à lame perforée
con hoja perforada

Fig. 1 21571-1

Fig. 2 21571-2

Fig. 3 21571-3



SCHWERT
SWORD · ESPADA
EPEE · SPADA

**Mundsperrer
Mouth Gags
Ouvre-Bouches
Abre-bocas**



Heister

21644

13,0 cm/5"



Roser-König

21670

16,0 cm/6¼"



Denhart

21666

12,0 cm/4¾"



Molt

21655

11,0 cm/4½"

21656

14,0 cm/5½"



Jennings

21694-9

9,0 cm/3½"

21694-11

11,0 cm/4½"

21694-13

13,0 cm/5"

21694-15

15,0 cm/6"

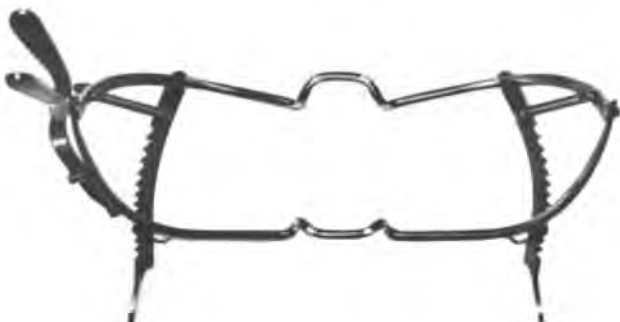

Whitehead

21685-11

11,0 cm/4½"

21685-13

13,0 cm/5"

**Mundsperrer
Mouth Gags
Ouvre-Bouches
Abre-bocas**



SCHWERT
SWORD · ESPADA
EPEE · SPADA

Davis-Boyle

Zungenspatel allein, Tongue Depressor only, Abaisse-langue seule, Abaja-lengua suelta



Fig. 1

21719-1
21x30 mm

Fig. 2

21720-2
23x65 mm

Fig. 3

21720-3
24x80 mm

Fig. 4

21720-4
25x93 mm

Fig. 5

21720-5
26x108 mm



Davis-Boyle

Griff allein, Handle only, Manche seul, Mango suelo

21720-GL

für Erwachsene
for adults
pour adultes
para adultos

21717-GL

für Jugendliche
for young people
pour jeunes gens
para menores

21716-GL

für Kinder
for children
pour enfants
para niños



21720-SI

Paar Silikoneinlagen allein
Pair of silicon inserts only
Paire de protection translucid seule
Par de silicon piezas solo

Davis-Boyle

21720-L

Satz, komplett mit:
Griff **21720-GL**, 2 Silikoneinlagen
5 auswechselbaren Zungenspateln **21719-1, 21720-2/3/4/5**

Set, complete with:
handle **21720-GL**, 2 silicon inserts
5 interchangeable tongue depressors **21719-1, 21720-2/3/4/5**

Jeu, complet avec:
manche **21720-GL**, une paire de protection translucid
5 abaisse-langues interchangeables **21719-1, 21720-2/3/4/5**

Juego, completo con:
mango **21720-GL**, un par de silicon piezas
5 abaja-lenguas intercambiables **21719-1, 21720-2/3/4/5**





SCHWERT
SWORD · ESPADA
EPEE · SPADA

Mundsperrer Mouth Gags Ouvre-Bouches Abre-bocas



Mc Ivor

Zungenspatel allein, Tongue Depressor only
Abaisse-langue seule, Abaja-lengua suelta

Fig. 1

21735-1

23x70 mm

Fig. 2

21735-2

25x86 mm

Fig. 3

21735-3

26x100 mm



Mc Ivor

21735-G

Griff allein, Handle only
Manche seul, Mango suelo

Mc Ivor

21735

Satz, komplett mit:

Griff **21735-G**

3 auswechselbaren Zungenspateln **21735-1/2/3**

Set, complete with:

handle **21735-G**

3 interchangeable tongue depressors **21735-1/2/3**

Jeu, complet avec:

manche **21735-G**

3 abaisse-langues interchangeables **21735-1/2/3**

Juego, completo con:

mango **21735-G**

3 abaja-lenguas intercambiables **21735-1/2/3**

**Mundsperrer
Mouth Gags
Ouvre-Bouches
Abre-bocas**



SCHWERT
SWORD · ESPADA
EPEE · SPADA

Negus

Zungenspatel allein, Tongue Depressor only
Abaisse-langue seule, Abaja-lengua suelta



Fig. 1

21737-1

28x70 mm

Fig. 2

21737-2

30x80 mm

Fig. 3

21737-3

33x95 mm



Davis-Boyle

Griff allein, Handle only, Manche seul, Mango suelo

21720-GL

für Erwachsene
for adults
pour adultes
para adultos

21717-GL

für Jugendliche
for young people
pour jeunes gens
para menores

21716-GL

für Kinder
for children
pour enfants
para niños



21720-SI

Paar Silikoneinlagen allein
Pair of silcon inserts only
Paire de protection translucid seule
Par de silcon piezas solo



SCHWERT
SWORD · ESPADA
EPEE · SPADA

Mundsperrer Mouth Gags Ouvre-Bouches Abre-bocas



Kilner-Doughty (Russel-Davis)

Zungenspatel allein, Tongue Depressor only
Abaisse-langue seule, Abaja-lengua suelta

Fig. 1

21741-1

28x65 mm

Fig. 2

21741-2

32x75 mm

Fig. 3

21741-3

37x80 mm

Fig. 4

21741-4

40x90 mm

Fig. 5

21741-5

45x100 mm



Kilner-Doughty (Russel-Davis)

21741-G

Griff allein, Handle only
Manche seul, Mango suelo

Kilner-Doughty (Russel-Davis)

21741

Satz, komplett mit:

Griff **21741-G**

3 auswechselbaren Zungendrückern **21741-1/2/3**

2 beweglichen auswechselbaren Zahnplatten

1 Gaumenplatte für Zahnlose

Set, complete with:

handle **21741-G**

3 interchangeable tongue depressors **21741-1/2/3**

2 adjustable and exchangeable tooth plates

1 palatal support for toothless people

Jeu, complet avec:

manche **21741-G**

3 abaisse-langues interchangeables **21741-1/2/3**

2 supports mobiles et interchangeables des dents

1 support du palais pour edentes

Juego, completo con:

mango **21741-G**

3 abaja-lenguas intercambiables **21741-1/2/3**

2 soportes de dientes móviles e intercambiables

1 soporte de paladar para desdentados

Zungenspatel
Tongue Depressors
Abaisse-langues
Abaja-lenguas



SCHWERT
SWORD · ESPADA
EPEE · SPADA



21751
14,0 cm/5½"



Buchwald
21750-14
14,5 cm/5¾"



Buchwald
21750-18
18,0 cm/7"



Bruenings
21760
19,0 cm/7½"



massiv
solid
massif
macizo

Tobold
21795
19,0 cm/7½"



21775-1
14,0 cm/5½"



21775-2
15,0 cm/6"

Wieder



Doyen
21770-12 13,0 cm/5"
21770-16 16,0 cm/6¼"



Andrew
21777
11,0 cm/4½"



SCHWERT
SWORD · ESPADA
EPEE · SPADA

Zungenzangen
Tongue Holding Forceps
Pincés tire-langue
Pinzas tira-lengua

Frakturschiene
Fracture Fixation Splint
Fil de fracture
Alambre de fractura



Collin

21894-17 17,0 cm/6¾"
21894-19 19,0 cm/7½"



Young

21897 16,0 cm/6¼"



21897-5

Paar Ersatzgummi
Pair of replacement rubber inserts
Paire de caoutchouc de rechange
Par de goma de recambio



21911

1 m Rolle / coil

Frakturschiene
Fracture Fixation Splint
Fil de fracture
Alambre de fractura

Tonsillenzangen
Tonsil Seizing Forceps
Pinces à préhension des amygdales
Pinzas para coger las amígdalas



SCHWERT
 SWORD · ESPADA
 EPEE · SPADA



Fig. 1

13691

Schnidt
 19,0 cm/7½"



Fig. 2

13692

Schnidt
 19,0 cm/7½"

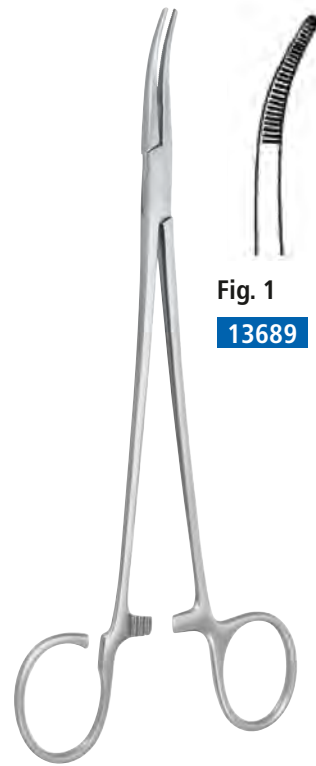

Fig. 1

13689

Schnidt
 19,0 cm/7½"



Fig. 2

13690



White

22388-18

18,0 cm/7"



Blohmke

22443

22,0 cm/8"





SCHWERT
SWORD - ESPADA
EPEE - SPADA

Tonsillenschnürer
Tonsil Snares
Serre-noeuds pour l'ablation des amygdales
Cierra-nudos para amígdalas



Bruenings

22020

28,0 cm/11"



Eves

22024

28,0 cm/11"



Eves

22025

28,0 cm/11"



20937

Ø 0,3 mm/100 mm

20937-90

Ø 0,3 mm/90 mm

Drahtschlingen, geschnitten
(Pack je 12 Stück)

Snare wires, cut
(pack of 12 pieces)

Anses coupées
(paquet a 12 pieces)

Asas preparadas
(paquete con 12 piezas)



Tyding

22031

mit 1 geraden Aufsatz
with 1 straight tip
avec 1 guide-anse droit
con 1 guía-asa recta

Tonsillennmesser, -dissektoren, -enukleatoren, -retraktoren
Tonsil Knives, Dissectors, Enucleators, Retractors
Bistouris pour amygdales, Dissecteurs, Enucleateurs, Ecarteurs
Bisturías para amígdalas, Disecadores, Enucleadores, Separadores



SCHWERT
 SWORD · ESPADA
 EPEE · SPADA



Tonsillennmesser und -enukleatoren
 Tonsil Knives and Enucleators
 Bistouris et Enucleateurs pour amygdales
 Bisturías y Enucleadores para amígdalas

Carpenter
22128
 25,0 cm/10"



Carpenter
22129
 24,0 cm/9½"



Tonsillennmesser und -retractor
 Tonsil Knives and Retractor
 Dissecteur et Retracteur pour amygdales,
 Disecador y Separador para amígdalas

Hurd
22120
 22,5 cm/9"

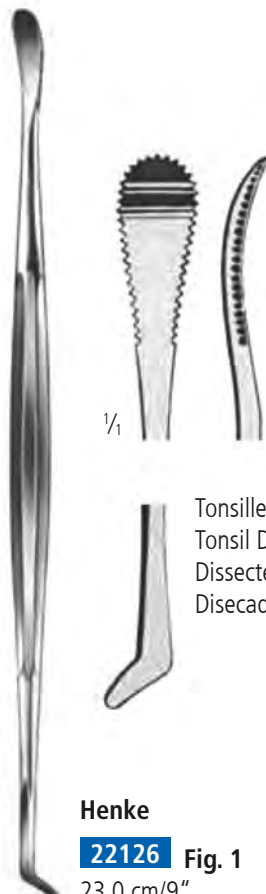

Tonsillendissektor und -separator
 Tonsil Dissector
 Dissecteur pour amygdales
 Disecador para amígdalas

Henke
22126 Fig. 1
 23,0 cm/9"

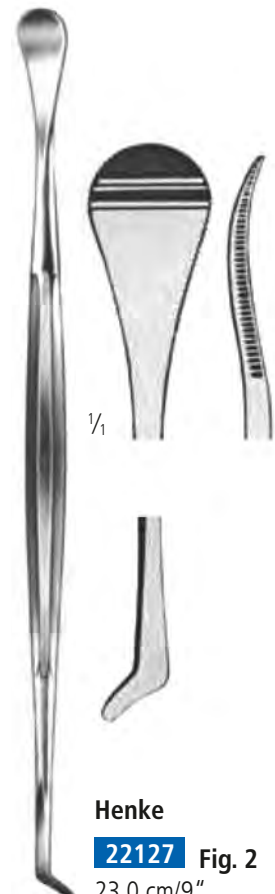

Henke
22127 Fig. 2
 23,0 cm/9"





**Tonsillotome
Tonsillectomes
Amygdalotomes
Amigdalótomos**

SCHWERT
SWORD · ESPADA
EPEE · SPADA



Fig. 1



Fig. 2



Fig. 3



Sluder-Ballenger

Sluder-Ballenger

22061

mit Aufsatz **Fig. 1**
with tip **Fig. 1**
avec lame **Fig. 1**
con hoja **Fig. 1**

22062

mit Aufsatz **Fig. 1/2**
with tip **Fig. 1/2**
avec lame **Fig. 1/2**
con hoja **Fig. 1/2**

22063

mit Aufsatz **Fig. 1/2/3**
with tip **Fig. 1/2/3**
avec lame **Fig. 1/2/3**
con hoja **Fig. 1/2/3**

Ohrküretten
Ear Currettes
Curettes auriculaires
Curetas auriculares



SCHWERT
SWORD · ESPADA
EPEE · SPADA

gerade, straight, droite, recta



1/2
Buck
16,5 cm/6 1/2"



stumpf
blunt
mousse
roma



Fig. 000	Fig. 00	Fig. 0	Fig. 1	Fig. 2	Fig. 3	Fig. 4
20509-30	20509-20	20509-0	20509-1	20509-2	20509-3	20509-4



scharf
sharp
tranchante
aguda



Fig. 000	Fig. 00	Fig. 0	Fig. 1	Fig. 2	Fig. 3	Fig. 4
20508-30	20508-20	20508-0	20508-1	20508-2	20508-3	20508-4

gebogen, curved, courbe, curva



1/2
Buck
16,5 cm/6 1/2"



stumpf
blunt
mousse
roma



Fig. 000	Fig. 00	Fig. 0	Fig. 1	Fig. 2	Fig. 3	Fig. 4
20511-30	20511-20	20511-0	20511-1	20511-2	20511-3	20511-4



scharf
sharp
tranchante
aguda



Fig. 000	Fig. 00	Fig. 0	Fig. 1	Fig. 2	Fig. 3	Fig. 4
20510-30	20510-20	20510-0	20510-1	20510-2	20510-3	20510-4



SCHWERT
SWORD · ESPADA
EPEE · SPADA

Ohrküretten
Ear Curettes
Curettes auriculaires
Curetas auriculares

Oherschlingen
Ear Loops
Anses auriculaires
Asas auriculares

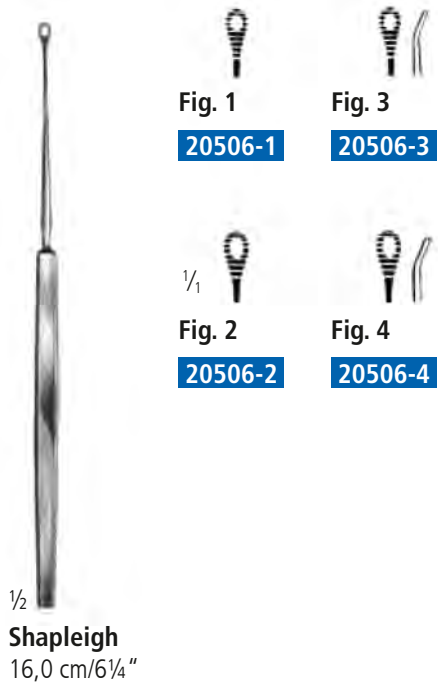

Oherschlingen
Ear Loops
Anses auriculaires
Asas auriculares



Ohrhäkchen
Ear Hooks
Crochets auriculaires
Ganchos auriculares

Diverse Ohrinstrumente
Miscellaneous Ear Instruments
Instruments divers pour les oreilles
Instrumentos diversos para orejas



SCHWERT
 SWORD · ESPADA
 EPEE · SPADA

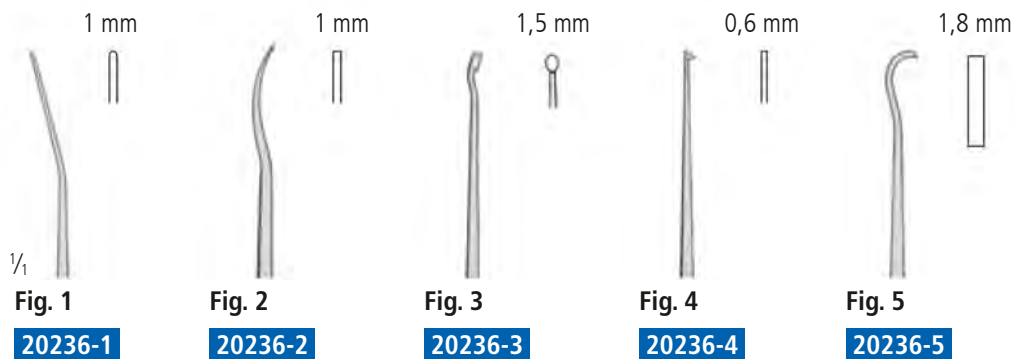
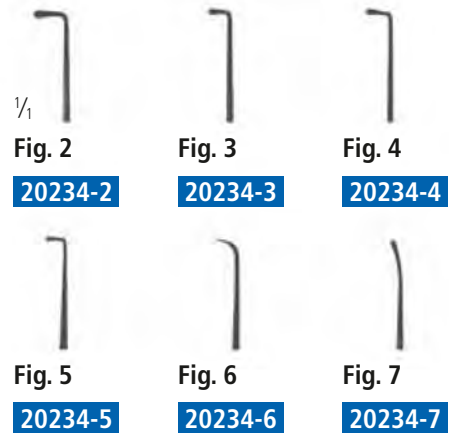
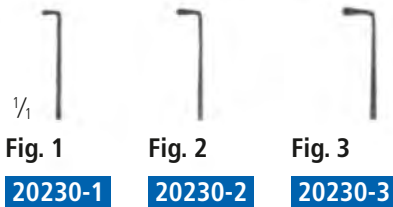

Elevatorium
 Elevator
 Elévateur
 Elevador

Raspatorium
 Periosteal Raspatory
 Rugine-raspatoire
 Legra-Periostótomo

Kürette
 Curette
 Curette
 Cutetta

Häkchen
 Hooklet
 Crochet
 Gancho

Raspatorium
 Periosteal Raspatory
 Rugine-raspatoire
 Legra-Periostótomo



SCHWERT
SWORD · ESPADA
EPEE · SPADA

**Parazentesenadeln
Paracentesis Needles
Aiguilles à paracentèse
Agujas para paracentesis**

**Trommelfellmesser
Tympanum Knives
Couteaux à tympan
Cuchillos para tímpano**

Parazentesenadeln, Paracentesis Needles, Aiguilles à paracentèse, Agujas para paracentesis



Lucae (Royce)

20290 Fig. 1
18,0 cm/7"



Lucae (Royce)

20290-5 Fig. 2
18,0 cm/7"

Nadel quergestellt
Needle horizontal position
Aiguille en position horizontale
Aguja en posición horizontal

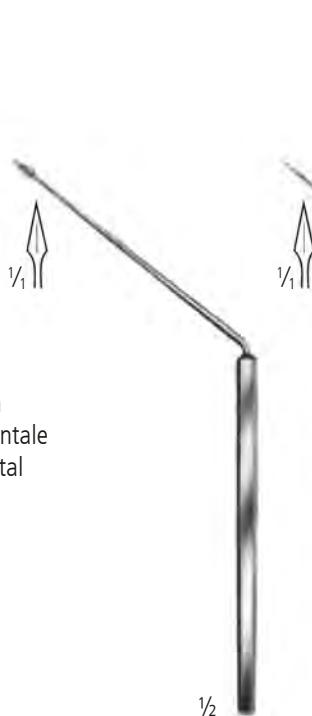

Poltizer

20286 Fig. 1
16,5 cm/6 1/2"

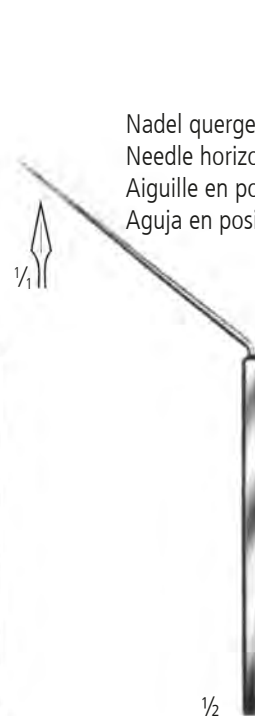

Poltizer

20286-5 Fig. 2
16,5 cm/6 1/2"

Nadel quergestellt
Needle horizontal position
Aiguille en position horizontale
Aguja en posición horizontal

Trommelfellmesser, Tympanum Knives, Couteaux à tympan, Cuchillos para tímpano



Sexton

20296-1 Fig. 1
18,0 cm/7"



Sexton

20296-2 Fig. 2
17,0 cm/6 3/4"



Sexton

20296-3 Fig. 3
17,0 cm/6 3/4"

Ohrzängchen
Ear Polypus Forceps
Pinces pour polypes auriculaires
Pinzas para pólipos

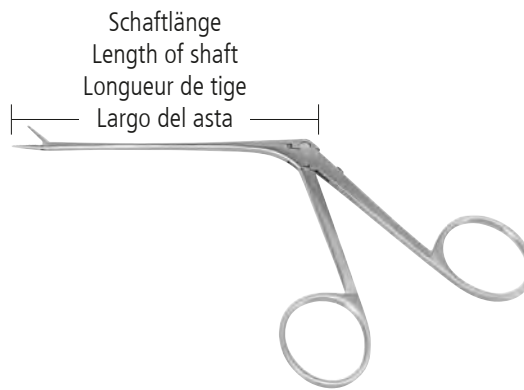

SCHWERT
 SWORD · ESPADA
 EPEE · SPADA

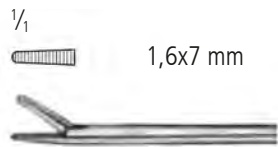

Hartmann

- 20380-2** 8,0 cm/3½"
 - 20380-3** 21,0 cm/8¼"
 - 20380-4** 16,0 cm/6¼"
- Schaftlänge
 Length of shaft
 Longueur de tige
 Largo del asta

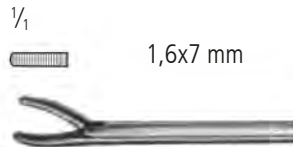

Hartmann-Weingärtner

- 20380-6** 8,0 cm/3½"
- Schaftlänge
 Length of shaft
 Longueur de tige
 Largo del asta



Hartmann

- 20380-7** 8,0 cm/3½"
- Schaftlänge
 Length of shaft
 Longueur de tige
 Largo del asta

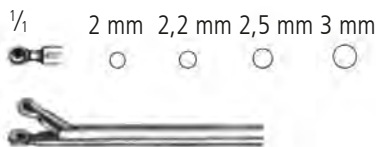

Hartmann-Noyes

- 20380-20** 2 mm 8,0 cm/3½"
 - 20380-22** 2,2 mm Schaftlänge
 - 20380-25** 2,5 mm Length of shaft
 - 20380-30** 3 mm Longueur de tige
- Largo del asta

Löffelmaul
 Spoon-shaped jaw
 Mors en forme d'un cuiller
 Boca en forma de cucharilla



Struempel

- 20380-35** 8,0 cm/3½"
- Schaftlänge
 Length of shaft
 Longueur de tige
 Largo del asta





SCHWERT
SWORD · ESPADA
EPEE · SPADA

Ohrzängchen
Ear Polypus Forceps
Pinces pour polypes auriculaires
Pinzas para pólipos

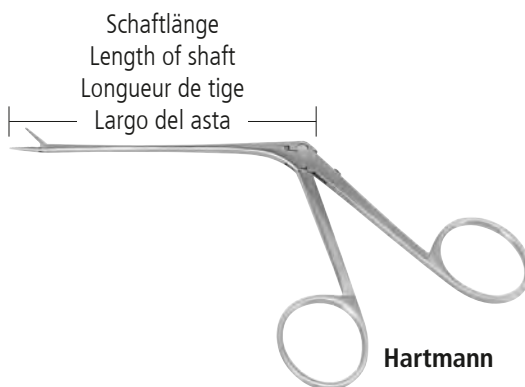

mittelfein

1,2x1,8 mm Schaft · Shaft · Tige · Asta

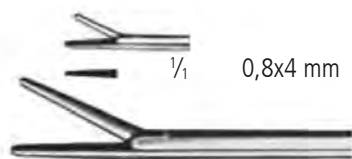

20381-1 7,5 cm/3"
glatt Schaftlänge
smooth Length of shaft
lisse Longueur de tige
lisa Largo del asta

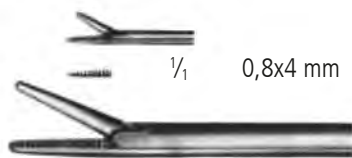

20381-2 7,5 cm/3"
gerieft Schaftlänge
serrated Length of shaft
striée Longueur de tige
estriada Largo del asta

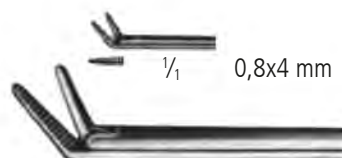

20381-3 7,5 cm/3"
gerieft Schaftlänge
serrated Length of shaft
striée Longueur de tige
estriada Largo del asta

1,8x2,5 mm Schaft · Shaft · Tige · Asta

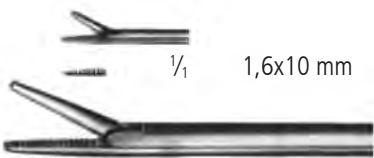

20381-4 8,0 cm/3 1/2"
gerieft Schaftlänge
serrated Length of shaft
striée Longueur de tige
estriada Largo del asta

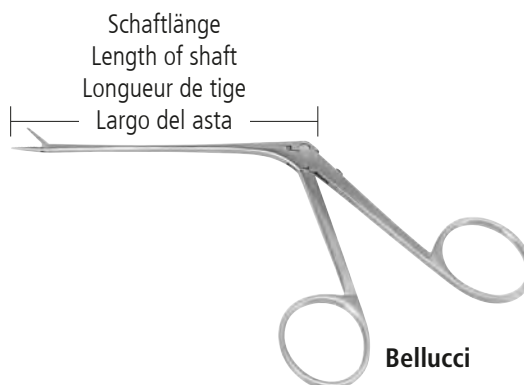

Mikro-Ohrzängchen
Micro Ear Polypus Forceps
Micro-Pinces pour polypes auriculaires
Micro-Pinzas para pólipos



SCHWERT
 SWORD · ESPADA
 EPEE · SPADA

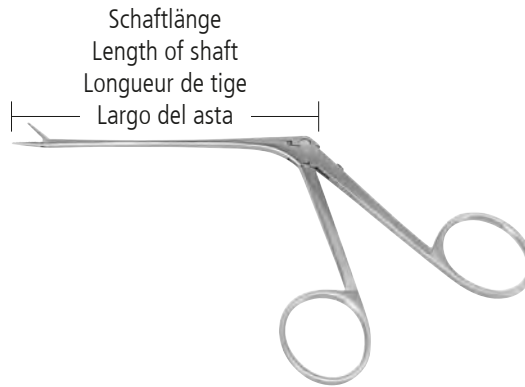

sehr fein

0,8x1,8 mm Schaft · Shaft · Tige · Asta

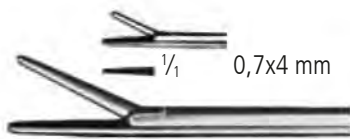

20382-1 8,0 cm/3½"
 glatt Schaftlänge
 smooth Length of shaft
 lisse Longueur de tige
 lisa Largo del asta



20382-2 8,0 cm/3½"
 gerieft Schaftlänge
 serrated Length of shaft
 striée Longueur de tige
 estriada Largo del asta

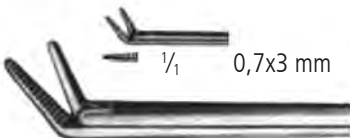

20382-3 8,0 cm/3½" nach oben abgewinkelt
 gerieft Schaftlänge angular upwards
 serrated Length of shaft coudeé vers le haut
 striée Longueur de tige angulada hacia arriba
 estriada Largo del asta



20382-4 8,0 cm/3½" nach rechts abgewinkelt
 gerieft Schaftlänge angular to the right
 serrated Length of shaft coudeé vers la droite
 striée Longueur de tige angulada a la derecha
 estriada Largo del asta

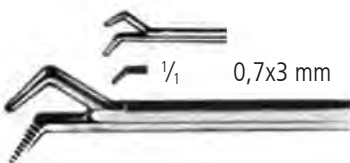

20382-5 8,0 cm/3½" nach links abgewinkelt
 gerieft Schaftlänge angular to the left
 serrated Length of shaft coudeé vers la gauche
 striée Longueur de tige angulada a la izquierda
 estriada Largo del asta

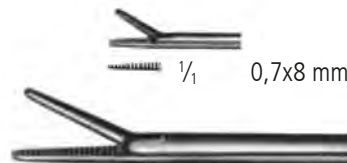

20382-6 8,0 cm/3½"
 gerieft Schaftlänge
 serrated Length of shaft
 striée Longueur de tige
 estriada Largo del asta

superfein

0,6x1,5 mm Schaft · Shaft · Tige · Asta

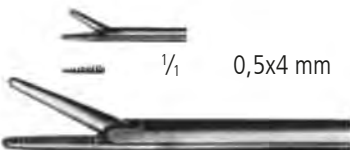

20382-7 8,0 cm/3½"
 gerieft Schaftlänge
 serrated Length of shaft
 striée Longueur de tige
 estriada Largo del asta

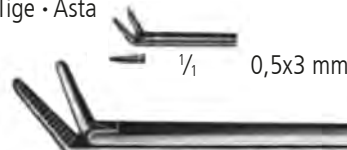

20382-8 8,0 cm/3½" nach oben abgewinkelt
 gerieft Schaftlänge angular upwards
 serrated Length of shaft coudeé vers le haut
 striée Longueur de tige angulada hacia arriba
 estriada Largo del asta



SCHWERT
SWORD · ESPADA
EPEE · SPADA

Fremdkörperheber
Foreign Body Levers
Leviers pour corps étrangers
Elevadores para cuerpos extraños

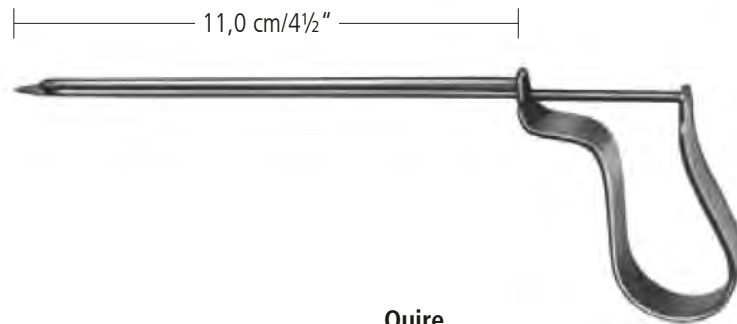

Quire

20375

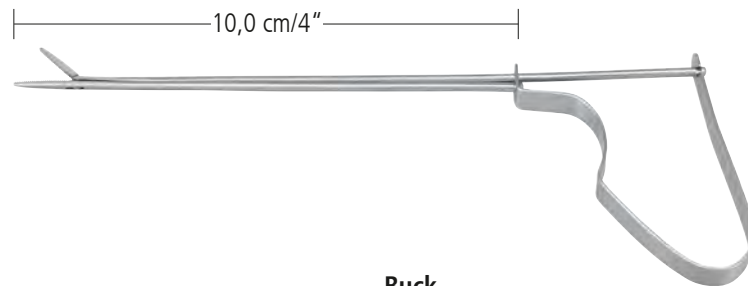

Buck

20377



SCHWERT
SWORD · ESPADA
EPEE · SPADA

Narkose Anaesthesia Anesthésie Anestesia





SCHWERT
SWORD · ESPADA
EPEE · SPADA

Laryngoskope Laryngoscopes Laryngoscopes Laringoscopios



McIntosh

23211

Laryngoskopie-Besteck, bestehend aus:
Laryngoscope set, consisting of:
Trousse à laryngoscopie, composée de :
Juego para laryngoscopia, compuesto de:

Etui, case, boîte, estuche (**23211-13**)
Griff, handle, manche, mango (**23230**)
Spatel, blades, spatules, hojas

Fig. 1 **23211-1**

Fig. 2 **23211-2**

Fig. 3 **23211-3**



McIntosh

23212

Laryngoskopie-Besteck, bestehend aus:
Laryngoscope set, consisting of:
Trousse à laryngoscopie, composée de :
Juego para laryngoscopia, compuesto de:

Etui, case, boîte, estuche (**23211-13**)
Griff, handle, manche, mango (**23230**)
Spatel, blades, spatules, hojas

Fig. 1 **23211-1**

Fig. 2 **23211-2**

Fig. 3 **23211-3**

Fig. 4 **23211-4**

23211-13

Etui allein, passend für McIntosh Spatel und Griff
Case only, for McIntosh blades and handle
Boîte seule, pour McIntosh spatules et manche
Estuche solo, para McIntosh hojas y mango

Fig. 1 **23211-1**

Fig. 2 **23211-2**

Fig. 3 **23211-3**

Laryngoskope
Laryngoscopes
Laryngoscopes
Laringoscopios



SCHWERT
SWORD · ESPADA
EPEE · SPADA



McIntosh

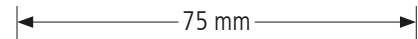

Fig. 0

23211-0

23230

Griff
Handle
Manche
Mango

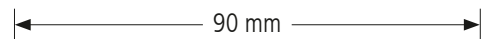

Fig. 1

23211-1



23211-L1

Ersatzbirne klein, 2,5 V
Spare bulb small, 2,5 V
Lampe de rechange petite, 2,5 V
Bombilla de repuesto pequena, 2,5 V



Fig. 2

23211-2



23211-L2

Ersatzbirne groß, 2,5 V
Spare bulb large, 2,5 V
Lampe de rechange grande, 2,5 V
Bombilla de repuesto grande, 2,5 V

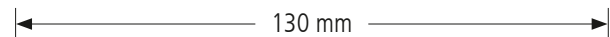

Fig. 3

23211-3

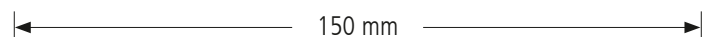

Fig. 4

23211-4



SCHWERT
SWORD · ESPADA
EPEE · SPADA

**Laryngoskope
Laryngoscopes
Laryngoscopes
Laringoscopios**



23230

Griff
Handle
Manche
Mango

Miller

23225

Laryngoskopie-Besteck, bestehend aus:
Laryngoscope set, consisting of:
Trousse à laryngoscopie, composée de :
Juego para laryngoscopia, compuesto de:

Etui, case, boîte, estuche (23225-15)
Griff, handle, manche, mango (23230)
Spatel, blades, spatules, hojas

Fig. 0 23225-0

Fig. 1 23225-1

Fig. 2 23225-2

Fig. 3 23225-3

Fig. 4 23225-4

Miller



23211-L1

Ersatzbirne klein, 2,5 V
Spare bulb small, 2,5 V
Lampe de rechange petite, 2,5 V
Bombilla de repuesto pequeña, 2,5 V

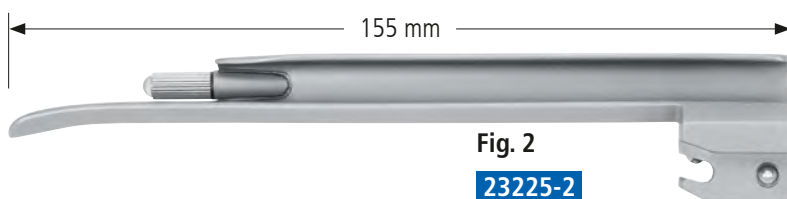

23211-L2

Ersatzbirne groß, 2,5 V
Spare bulb large, 2,5 V
Lampe de rechange grande, 2,5 V
Bombilla de repuesto grande, 2,5 V

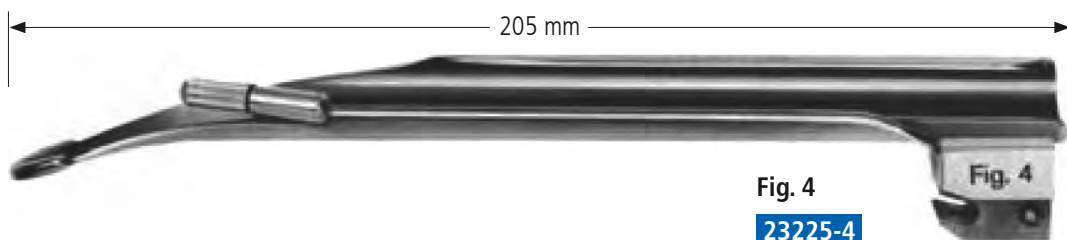
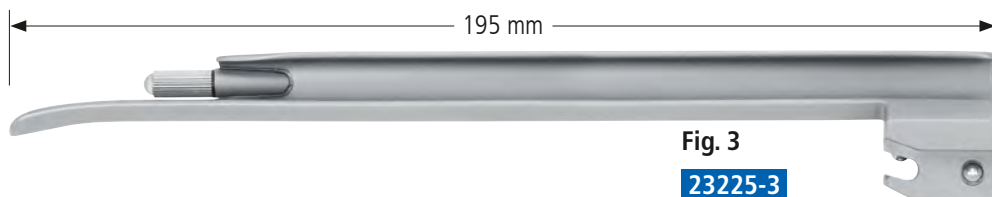

Laryngoskope
Laryngoscopes
Laryngoscopes
Laringoscopios



SCHWERT
SWORD · ESPADA
EPEE · SPADA



Etuis auf Anfrage erhältlich
Cases available on request
Bôîtes sont disponibles a demande
Estuches estan disponibles a pregunta

Foregger

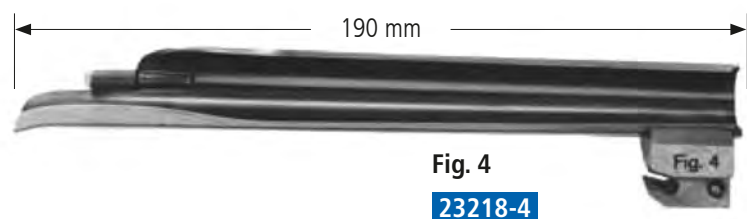
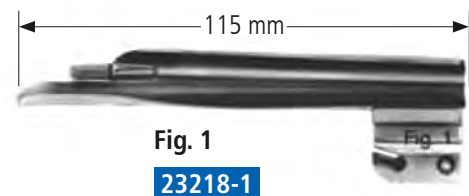

23211-L1

Ersatzbirne klein, 2,5 V
Spare bulb small, 2,5 V
Lampe de rechange petite, 2,5 V
Bombilla de repuesto pequena, 2,5 V



23211-L2

Ersatzbirne groß, 2,5 V
Spare bulb large, 2,5 V
Lampe de rechange grande, 2,5 V
Bombilla de repuesto grande, 2,5 V



Laryngoskop-Griffe
Laryngoscope handles
Manches pour laryngoscopes
Mangos para laringoscopios

SCHWERT
SWORD · ESPADA
EPEE · SPADA



23230
Ø 30 mm



23229
Ø 18 mm

Laryngoskope, Kaltlicht
Laryngoscopes, cold light
Laryngoscopes, lumière froide
Laringoscopios, luz fría



SCHWERT
SWORD · ESPADA
EPEE · SPADA

McIntosh

23251-13

Laryngoskopie-Besteck, bestehend aus:
Laryngoscope set, consisting of:
Trousse à laryngoscopie, composée de :
Juego para laryngoscopia, compuesto de:

Etui, case, boîte, estuche (**23211-13**)
Griff, handle, manche, mango (**23270**)
Spatel, blades, spatules, hojas

Fig. 1 **23251-1**

Fig. 2 **23251-2**

Fig. 3 **23251-3**

23211-13

Etui allein, passend für McIntosh Spatel und Griff
Case only, for McIntosh blades and handle
Boîte seule, pour McIntosh spatules et manche
Estuche solo, para McIntosh hojas y mango

Fig. 1 **23251-1**

Fig. 2 **23251-2**

Fig. 3 **23251-3**

McIntosh

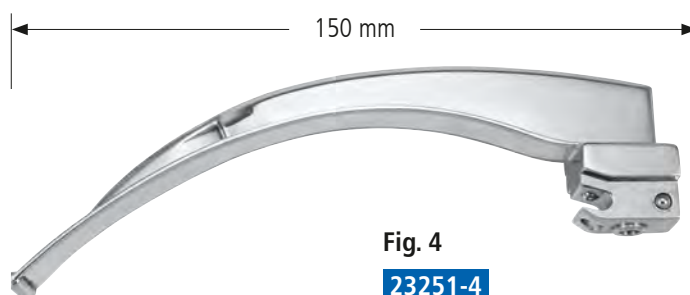



SCHWERT
SWORD · ESPADA
EPEE · SPADA

Laryngoskope, Kaltlicht
Laryngoscopes, cold light
Laryngoscopes, lumière froide
Laringoscopios, luz fría



Miller

23265-15

Laryngoskopie-Besteck, bestehend aus:
Laryngoscope set, consisting of:
Trousse à laryngoscopie, composée de :
Juego para laryngoscopia, compuesto de:

Etui, case, boîte, estuche (**23225-15**)
Griff, handle, manche, mango (**23270**)
Spatel, blades, spatules, hojas

Fig. 0 **23265-0**

Fig. 1 **23265-1**

Fig. 2 **23265-2**

Fig. 3 **23265-3**

Fig. 4 **23265-4**

Laryngoskope, Kaltlicht
Laryngoscopes, cold light
Laryngoscopes, lumière froide
Laringoscopios, luz fría



SCHWERT
SWORD · ESPADA
EPEE · SPADA

Miller

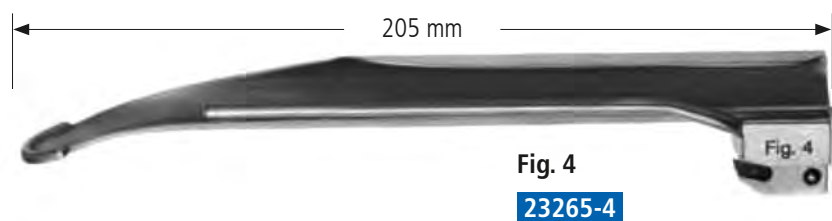
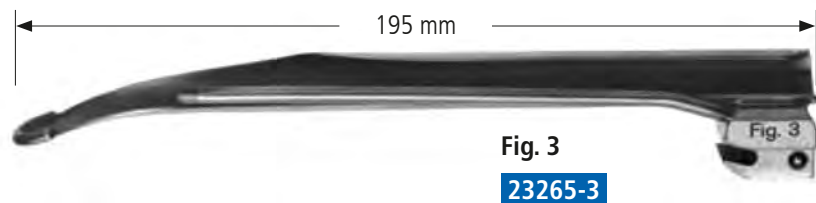
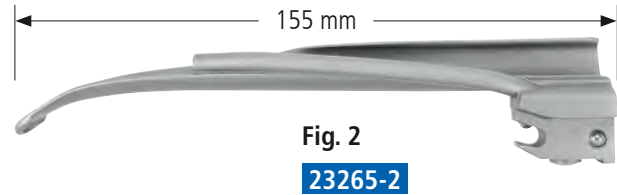
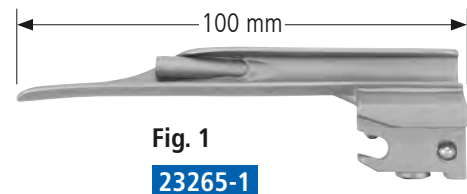
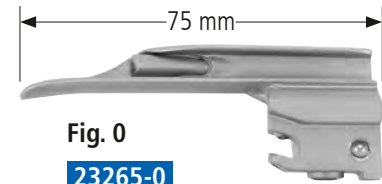



SCHWERT
SWORD · ESPADA
EPEE · SPADA

Laryngoskope, Kaltlicht
Laryngoscopes, cold light
Laryngoscopes, lumière froide
Laringoscopios, luz fría



Etuis auf Anfrage erhältlich
Cases available on request
Bôîtes sont disponibles a demande
Estuches estan disponibles a pregunta

Foregger

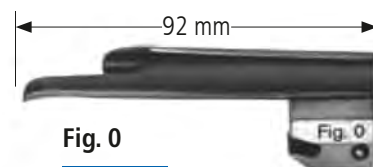

Fig. 0

23258-0



Fig. 1

23258-1



Fig. 2

23258-2



Fig. 3

23258-3

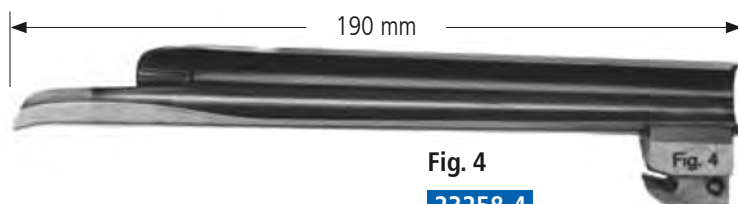

Fig. 4

23258-4

Laryngoskop-Griffe, Kaltlicht
Laryngoscope handles, cold light
Manches pour laryngoscopes, lumière froide
Mangos para laringoscopios, luz fría



SCHWERT
SWORD · ESPADA
EPEE · SPADA



23270
Ø 30 mm



23269
Ø 18 mm



23275-1

680 mA
Ersatzbirne Xenon für Glasfaseroptik-Griffe
Spare bulb xenon for fiber optic handles
Lampe de rechange xenon pour manches de fibre optique
Bombilla de repuesto xénon para mangos de fibra óptica



23275-3

500 mA
Ersatzbirne LED für Glasfaseroptik-Griffe
Spare bulb LED for fiber optic handles
Lampe de rechange LED pour manches de fibre optique
Bombilla de repuesto LED para mangos de fibra óptica



SCHWERT
SWORD · ESPADA
EPEE · SPADA

Tracheotomie Tracheotomy Trachéotomie Traqueotomía

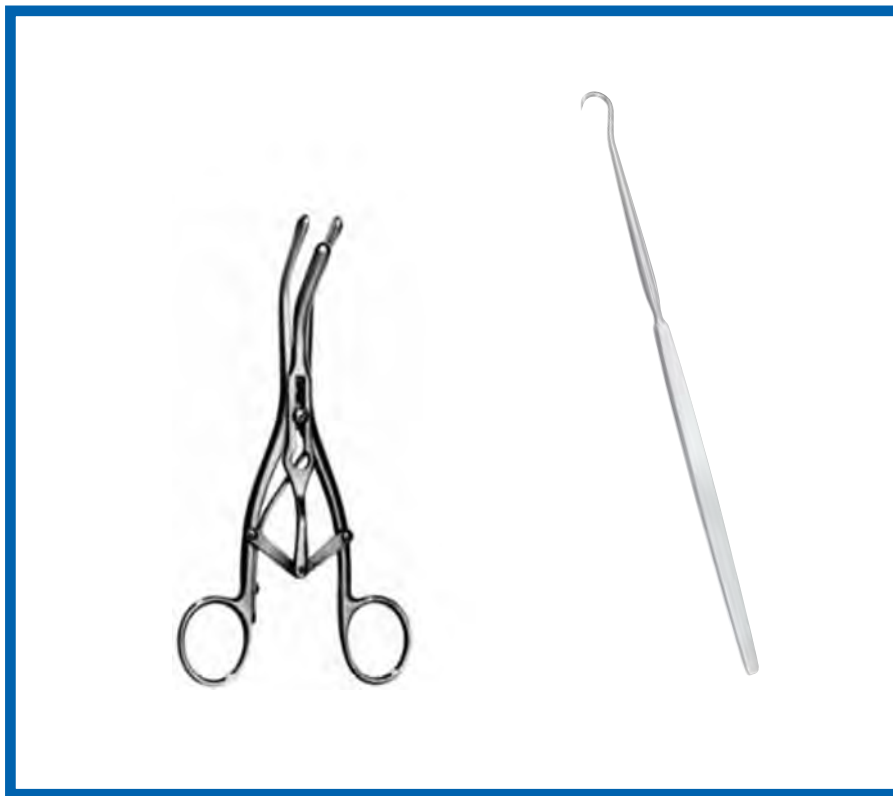

Tracheal-Dilatatoren
Trachea Dilators
Dilatateurs pour la trachéotomie
Dilatadores para la tráquea

Tracheal-Häkchen
Trachea Retractors
Crochets pour la trachéotomie
Ganchos para la tráquea



SCHWERT
 SWORD · ESPADA
 EPEE · SPADA



Trousseau

23587

14,0 cm/5½"

Tracheal-Dilatatoren
 Trachea Dilators
 Dilatateurs pour la trachéotomie
 Dilatadores para la tráquea



Laborde

23588

14,0 cm/5½"

Tracheal-Häkchen, Trachea Retractors, Crochets pour la trachéotomie, Ganchos para la tráquea



1/1
 links
 left
 gauche
 izquierda

Bose

23606-L

16,0 cm/6¼"



1/1
 rechts
 right
 droit
 derecha

Bose

23606-R

16,0 cm/6¼"



1/1
 spitz
 sharp
 pointue
 aguda

Iterson

23610

16,0 cm/6¼"

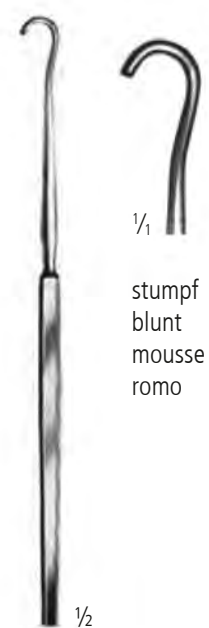

1/1
 stumpf
 blunt
 mousse
 romo

Iterson

23611

16,0 cm/6¼"





SCHWERT
SWORD - ESPADA
EPEE - SPADA

Tracheal-Häkchen
Trachea Retractors
Crochets pour la trachéotomie
Ganchos para la tráquea

Schilddrüsenhaken
Thyroid Gland Retractor
Ecarteur pour la thyroïde
Separador para la glándula tiroidea



Jackson

23614

15,0 cm/6"

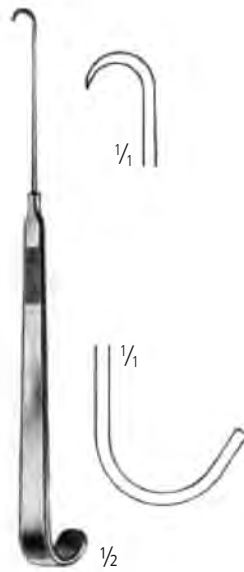

News

23615

15,0 cm/6"



Rose

23593

13,5 cm/5"

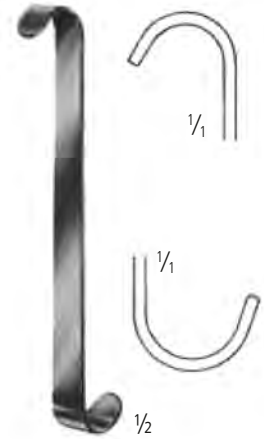

Luer

23590

11,0 cm/4½"



Lukens

23594

17,0 cm/6¾"



Jackson

23595

17,0 cm/6¾"



Schoenborn

23596

21,0 cm/8¼"

Schilddrüsenhaken
Thyroid Gland Retractor
Ecarteur pour la thyroïde
Separador para la glándula tiroidea

Kropffasszange
Goitre Grasping Forceps
Pincès à goitre
Pinzas coger-bocio



SCHWERT
SWORD · ESPADA
EPEE · SPADA



Kropffasszange
Goitre Grasping Forceps
Pincès à goitre
Pinzas coger-bocio

Lahey

23751

15,0 cm/6"

23751-20

20,0 cm/8"



SCHWERT
SWORD · ESPADA
EPEE · SPADA

Dermatologie

Dermatology

Dermatologie

Dermatologia



Hautstanzen
Dermal Punches
Trépanes cutanés
Trepanes cutáneos



SCHWERT
SWORD · ESPADA
EPEE · SPADA



Keyes

- **23830-2** 2 mm
- **23830-3** 3 mm
- **23830-4** 4 mm
- **23830-5** 5 mm
- **23830-6** 6 mm
- **23830-7** 7 mm
- **23830-8** 8 mm

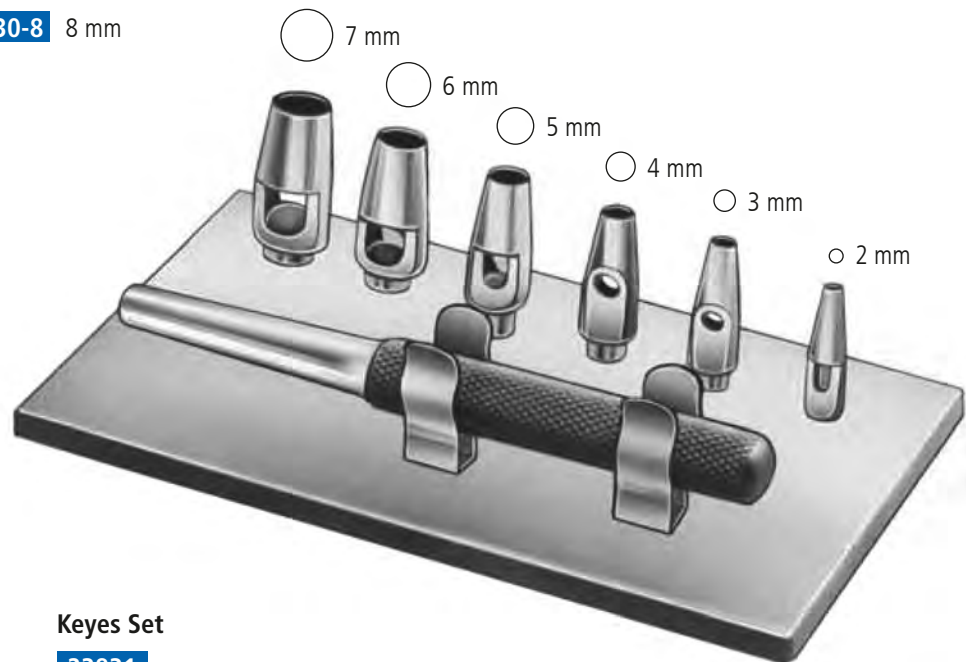

Keyes Set

23831

Hautstanze komplett, mit 6 auswechselbaren Stanzköpfen
Dermal Punch complete, with 6 interchangeable tips
Trépanes cutanés complets, avec 6 embouts interchangeables
Trepanos cutaneos completos, con 6 puntas intercambiables



SCHWERT
SWORD · ESPADA
EPEE · SPADA

Dermatome
Dermatomes
Dermatomes
Dermátomos



1/2

Schink

23840 30,0 cm/12"

Dermatom, einstellbar von 0,1 bis 2,0 mm, komplett, mit 1 auswechselbarer Klinge und 2 Spannplatten

Dermatome, adjustable from 0,1 to 2,0 mm, complete, with 1 interchangeable blade and 2 skin straightening blades

Dermatome, réglable en épaisseur de 0,1 à 2,0 mm, complet, avec 1 lame interchangeable et 2 plaques pour tendre la peau

Dermatome, graduable de 0,1 hasta 2,0 mms, completo, con 1 hoja intercambiable y 2 placas para extender la piel



1/2

23841

Ersatzklinge, allein
Spare blade only
Lame de rechange, seule
Hoja de repuesto, suela



1/2

23842

Spannplatte, allein
Skin straightening plate only
Plaque pour tendre la peau, seule
Placa para extender la piel, suelo



1/2

Silver

23846 19,0 cm/7 1/2"

Dermatom
Dermatome
Dermatome
Dermátome

Häkchen, Lupuslöffel
 Hooklets, Lupus Curettes
 Crochets, Curettes pour les lupus
 Ganchos, Curetas para lupus



SCHWERT
 SWORD · ESPADA
 EPEE · SPADA



18444-1



18444-2

Gillies
 18,0 cm/7"



Kilner
 15,0 cm/6"
 18442

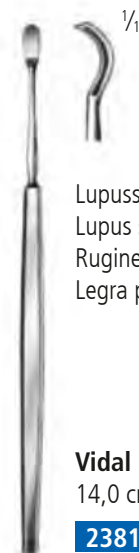

Lupusschaber
 Lupus scraper
 Rugine pour le lupus
 Legra para lupus

Vidal
 14,0 cm/5 1/2"
 23813

Lupusküretten
 Lupus curettes
 Curettes pour le lupus
 Curetas para lupus

Lupuslöffel
 Lupus Curettes
 Curettes pour les lupus
 Curetas para lupus

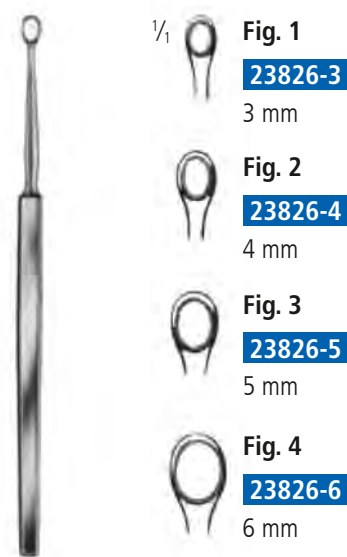

Fig. 1

23826-3

3 mm



Fig. 2

23826-4

4 mm



Fig. 3

23826-5

5 mm



Fig. 4

23826-6

6 mm

Fox
 14,0 cm/5 1/2"

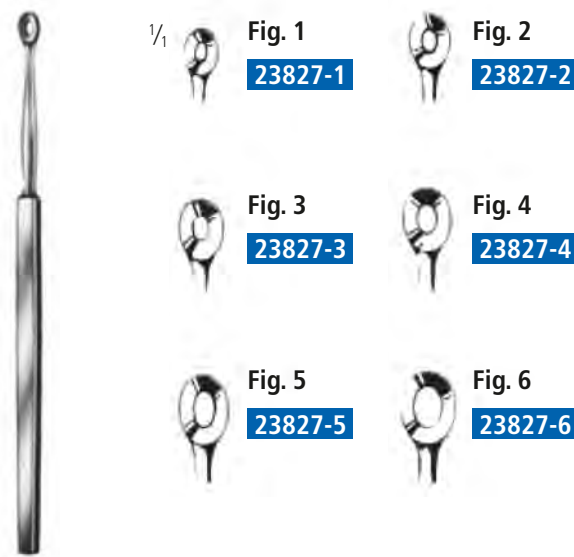

Fig. 1

23827-1



Fig. 2

23827-2



Fig. 3

23827-3



Fig. 4

23827-4



Fig. 5

23827-5



Fig. 6

23827-6

Wolff
 14,0 cm/5 1/2"



SCHWERT
SWORD · ESPADA
EPEE · SPADA

Komedoneninstrumente
Comedo Extractors
Tire-comédons
Saca-comédones



Unna
14,5 cm/5½"

23821

oval, oval
ovale, oval



Unna
14,5 cm/5½"

23822

rund, round
ronde, redondo



Saalfeld
11,0 cm/4"

23820-10



Saalfeld
14,5 cm/6"

23820



Schamberg
9,5 cm/4"

23824

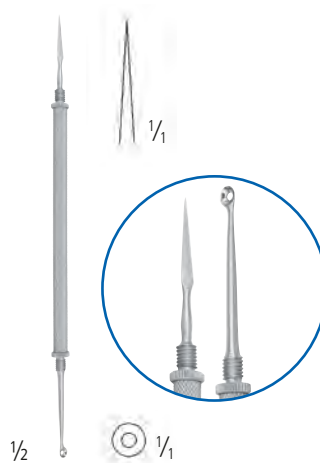

Unna-Vidal
11,5 cm/4½"

23818



SCHWERT
SWORD · ESPADA
EPEE · SPADA

Magen und Darm

Stomach, Intestine

Estomac, Intestin

Estómago, Intestina

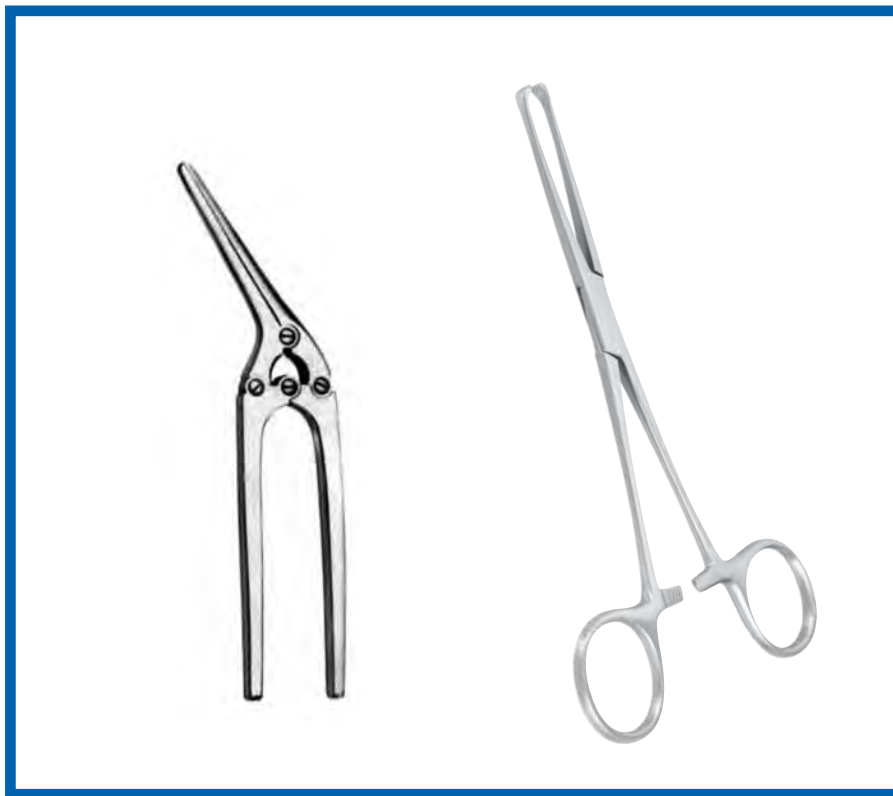



SCHWERT
SWORD · ESPADA
EPEE · SPADA

Darm- und Gewebefasszangen
Intestinal and Tissue Grasping Forceps
Pinces pour saisir l'intestin et le tissu
Pinzas para coger intestinos y tejidos



Allis

4:5

13736-15

15,0 cm/6"

5:6

13738-15 15,0 cm/6"

13738-19 19,0 cm/7½"

13738-23 22,0 cm/8¾"

13738-25 25,0 cm/10"

3:4

13744-15

15,0 cm/6"



Allis-Baby

13735-13 13,0 cm/5"

13735-14 14,0 cm/5½"



Allis-Adair

13741-16

15,5 cm/6"



Judd-Allis

13743-15 15,0 cm/6"

13743-19 19,0 cm/7½"



Boys-Allis

13745-15

15,0 cm/6"



Thoms-Allis

13746-20

20,0 cm/8"

Darm- und Gewebefasszangen
 Intestinal and Tissue Grasping Forceps
 Pincès pour saisir l'intestin et le tissu
 Pinzas para coger intestinos y tejidos



SCHWERT
 SWORD · ESPADA
 EPEE · SPADA



Lockwood-Allis

- 13747-16** 16,0 cm/6¼"
- 13747-20** 20,0 cm/8"



atraumatisch
 atraumatic
 atraumatique
 atraumatica

Allis

- 13739-15** 15,5 cm/6¼"
- 13739-20** 20,0 cm/8"
- 13739-22** 22,0 cm/9"
- 13739-25** 25,0 cm/10"



Babcock

- 16844-16** 16,0 cm/6¼"
- 16844-18** 18,0 cm/7"
- 16844-20** 20,0 cm/8"
- 16844-23** 24,0 cm/9½"



atraumatisch
 atraumatic
 atraumatique
 atraumatica



- 16846-16**
16,0 cm/6¼"

Babcock



- 16846-21**
21,0 cm/8¼"

Darmfasszange
 Intestinal Forceps
 Pincès pour saisir l'intestin
 Pinzas para coger intestinos



Darmfasszange
 Intestinal Forceps
 Pincès pour saisir l'intestin
 Pinzas para coger intestinos

Williams

- 16848-20**
20,0 cm/8"



SCHWERT
SWORD · ESPADA
EPEE · SPADA

Darmklemmen
Intestinal Clamp Forceps
Pinces-clamps intestinales
Pinzas-clamps intestinales

Pylorusspreizer
Pylorus spreader
Ecarteur du pylore
Separador para piloro



Pylorusspreizer
Pylorus spreader
Ecarteur du pylore
Separador para piloro

Benson

24510 15,5 cm/6"



Doyen

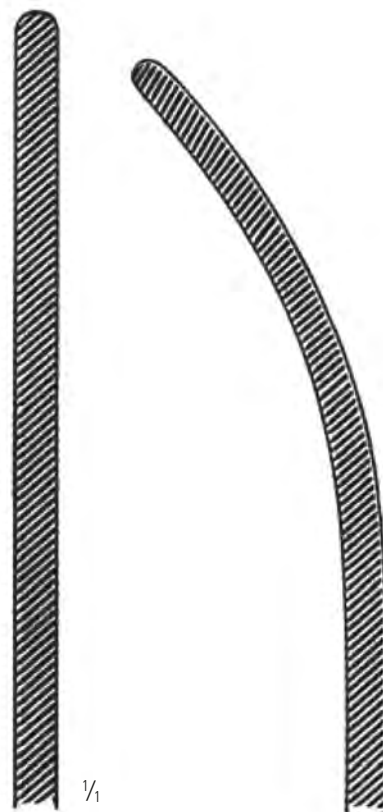

24568-17 17,0 cm/6¾"

24568-21 21,0 cm/8¼"

24568-23 23,0 cm/9"

24569-17

24569-21

24569-23



Mayo-Robson



24600-21 21,0 cm/8¼"

24600-23 23,0 cm/9"

24600-25 25,0 cm/10"

24601-21

24601-23

24601-25

24601-21

24601-23

24601-25

Darmklemmen
Intestinal Clamp Forceps
Pinces-clamps intestinales
Pinzas-clamps intestinales



Kocher

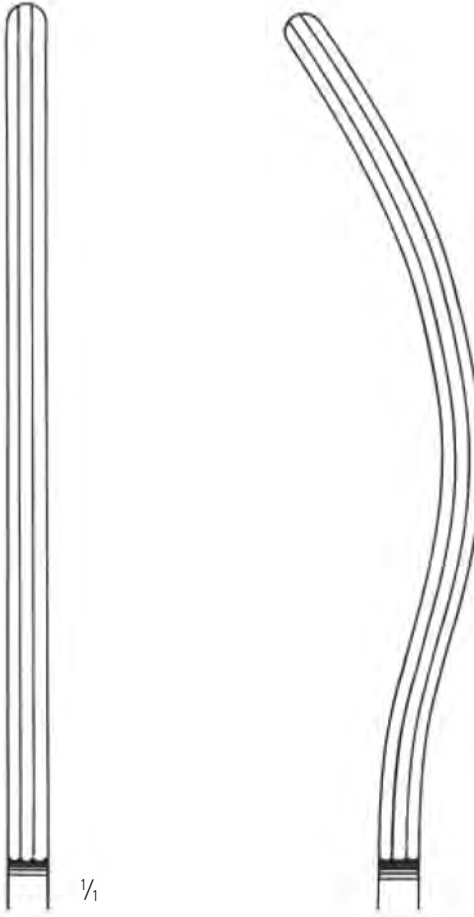

24584-22	22,0 cm/8¼"	24585-22
24584-25	25,0 cm/10"	24585-25
24584-28	28,0 cm/11"	24585-28

Darmklemmen
 Intestinal Clamp Forceps
 Pinces-clamps intestinales
 Pinzas-clamps intestinales

Anastomosenklemmen
Anastomosis Clamp Forceps
Pinces-clamps pour l'anastomose
Pinzas-clamps para anastomosis



De Martel-Wolfson

	Maullänge		
	Length of jaw		
	Longueur du mors		
	Longitud de boca		
	cm	inch	
Satz zu 3 Klemmen	5	2	24717-5
Set of 3 clamps	7	2¾	24717-7
Jeu de 3 clamps	10	4	24717-10
Juego de 3 clamps			



SCHWERT
 SWORD · ESPADA
 EPEE · SPADA



SCHWERT
SWORD - ESPADA
EPEE - SPADA

Klemmenhalter
Clamp holders
Porte-clamps
Porta-clamps

Klemmschließzangen
Clamp Closing Forceps
Pincès pour fermer les clamps
Pinzas para cerrar clamps



Klemmenhalter
Clamp holders
Porte-clamps
Porta-clamps



Klemmschließzangen
Clamp Closing Forceps
Pincès pour fermer les clamps
Pinzas para cerrar clamps

De Martel-Wolfson
24718-8
8,5 cm/3 1/2"

De Martel-Wolfson
24718-23
23,0 cm/9"

De Martel-Wolfson
24719
26,0 cm/10 1/4"



Darm- und Magenquetschklemme
Intestinal and Stomach Clamp
Pincès-clamps pour l'intestin et l'estomac
Pinzas-clamps intestinales y estomacales

- | | |
|--|--|
| ohne Stift
without pin
sans cheville
sin espiga | mit Stift
with pin
avec cheville
con espiga |
| 24725 15,0 cm/6" | 24725-1 |
| 24727 21,0 cm/8 1/4" | 24727-1 |
| 24731 29,0 cm/11 1/2" | 24731-1 |
| 24735 35,0 cm/13 3/4" | 24735-1 |

Payr

Darmklemmen
 Intestinal Clamp Forceps
 Pincés-clamps intestinales
 Pinzas-clamps intestinales



SCHWERT
 SWORD · ESPADA
 EPEE · SPADA



Doyen

- 24564-13** 13,0 cm/5¼"
- 24564-16** 16,0 cm/6¼"
- 24564-18** 18,0 cm/7"
- 24564-21** 21,0 cm/8½"
- 24564-23** 23,0 cm/9"

atraumatisch
 atraumatic
 atraumatique
 atraumática



Doyen

- 24565-13** 13,0 cm/5¼"
- 24565-16** 16,0 cm/6¼"
- 24565-18** 18,0 cm/7"
- 24565-21** 21,0 cm/8½"
- 24565-23** 23,0 cm/9"

atraumatisch
 atraumatic
 atraumatique
 atraumática



Darmklemmen
Intestinal Clamp Forceps
Pincas-clamps intestinales
Pinzas-clamps intestinales

SCHWERT
SWORD - ESPADA
EPEE - SPADA



Mayo-Robson

atraumatisch
atraumatic
atraumatique
atraumática

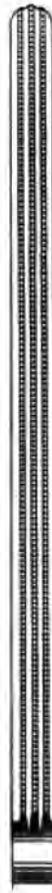

24602
25,0 cm/10"

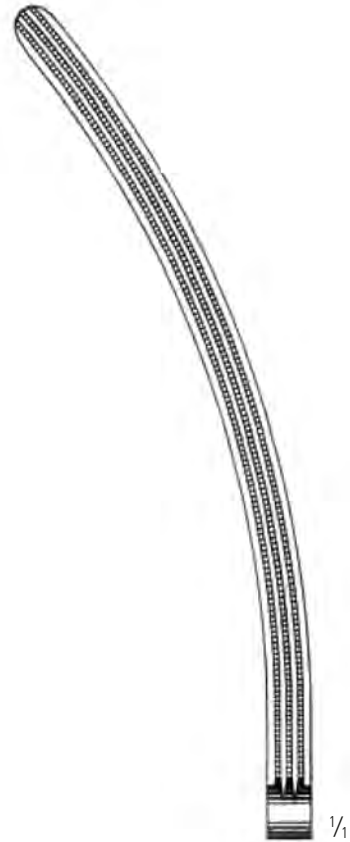

24603
25,0 cm/10"

Darmklemmen
 Intestinal Clamp Forceps
 Pincers-clamps intestinales
 Pinzas-clamps intestinales



SCHWERT
 SWORD · ESPADA
 EPEE · SPADA



Kocher

atraumatisch
 atraumatic
 atraumatique
 atraumática

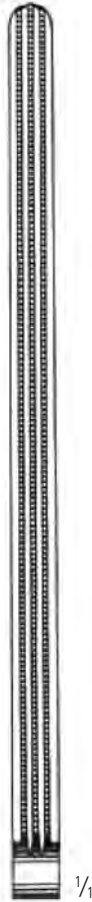

1/1

- 24586-22** 22,0 cm/8¾"
- 24586-25** 25,0 cm/10"
- 24586-28** 28,0 cm/11"



1/1

- 24587-22** 22,0 cm/8¾"
- 24587-25** 25,0 cm/10"
- 24587-28** 28,0 cm/11"



SCHWERT
SWORD · ESPADA
EPEE · SPADA

Galle, Niere, Urologie
Bile, Kidney, Urology
Bile, Rein, Urologie
Vesícula biliar, Riñon, Urología



Nierensteinzangen
Kidney Stone Forceps
Pinces pour les calculs du bassin
Pinzas para cálculos renales



SCHWERT
SWORD · ESPADA
EPEE · SPADA



Fig. 1

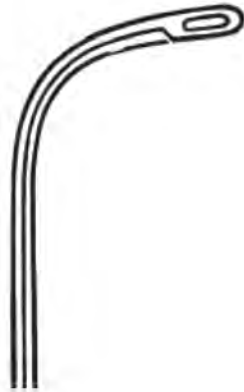

Fig. 2

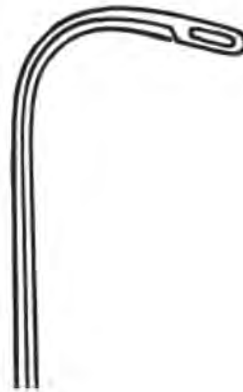

Fig. 3



Fig. 4

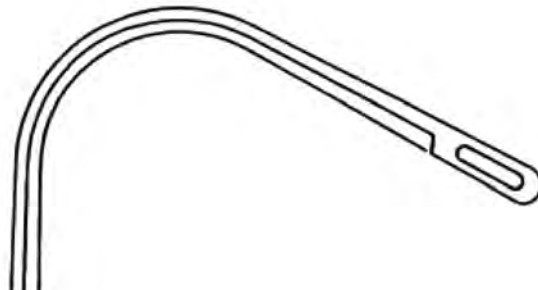

Fig. 5

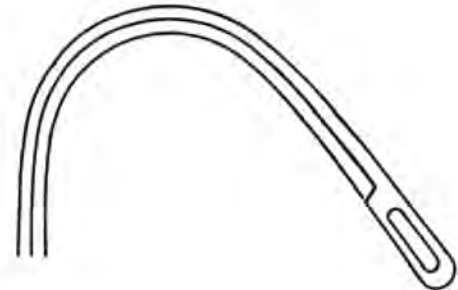

Fig. 6



Randall

- | | | |
|--------|----------------|-------------|
| Fig. 1 | 25050-1 | 23,0 cm/9" |
| Fig. 2 | 25050-2 | 22,0 cm/8¾" |
| Fig. 3 | 25050-3 | 22,0 cm/8¾" |
| Fig. 4 | 25050-4 | 22,0 cm/8¾" |
| Fig. 5 | 25050-5 | 19,0 cm/7½" |
| Fig. 6 | 25050-6 | 19,0 cm/7½" |



SCHWERT
SWORD - ESPADA
EPEE - SPADA

Gallensteinzangen
Gall Stone Forceps
Pinces pour calculs biliaires
Pinzas para cálculos biliares

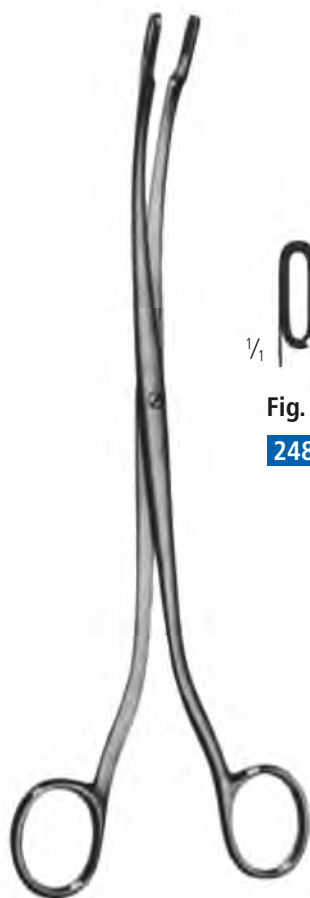

Desjardins
23,0 cm/9"



Fig. 1

24879-1



Fig. 2

24879-2



Blake
20,0 cm/8"



24884

gerade
straight
droits
rectas



24885

gebogen
curved
courbes
curvas

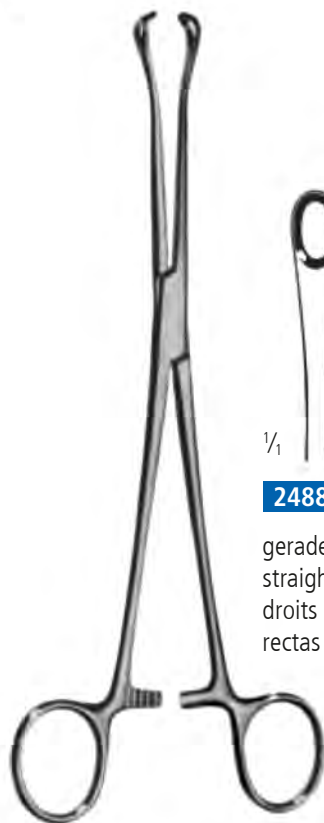

Mayo-Blake
20,0 cm/8"



24886

gerade
straight
droits
rectas



24887

gebogen
curved
courbes
curvas



Mixer

24889

22,0 cm/8¾"



Gallensteinsonden
Gall Stone Probes
Sondes à calculs biliaires
Sondas-exploradoras para cálculos biliares

Gallengangdilatoren
Bile Duct Dilators
Dilatateurs à voies biliaires
Dilatadores para conductos biliares



SCHWERT
 SWORD · ESPADA
 EPEE · SPADA



Ø 4 mm
 biegsam
 malleable
 malléable
 maleable

Mayo

24818

32,0 cm/12½"



24838-1



24838-2



24838-3

federnd
 elastic
 élastique
 elástica

Desjardins

28,0 cm/11"



biegsam
 malleable
 malléable
 maleable

Bakes

30,0 cm/12"

Gallengangdilatoren
 Bile Duct Dilators
 Dilatateurs à voies biliaires
 Dilatadores para conductos biliares

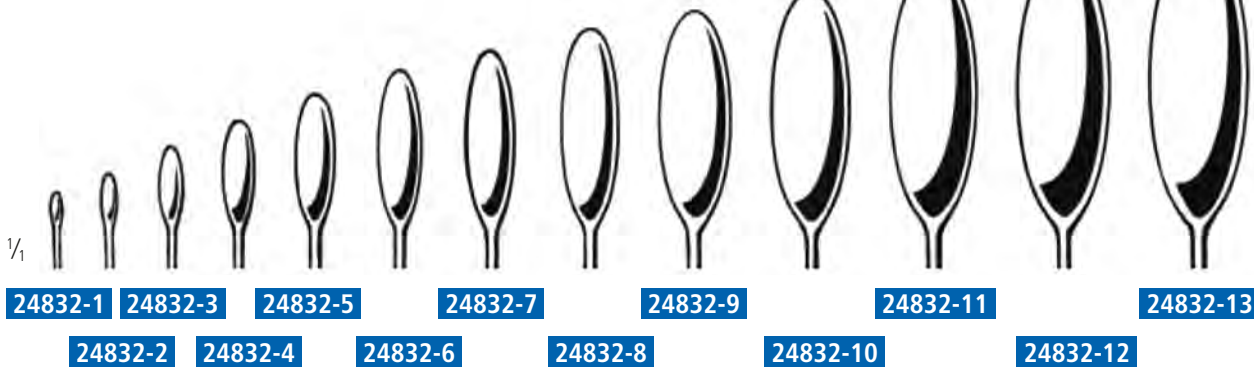

24832-1

24832-2

24832-3

24832-4

24832-5

24832-6

24832-7

24832-8

24832-9

24832-10

24832-11

24832-12

24832-13



Gallensteinlöffel
Gall Stone Scoops
Curettes pour calculs biliaries
Cucharillas para cálculos biliares

SCHWERT
SWORD · ESPADA
EPEE · SPADA



Luer-Koerte
32,0 cm/12³/₄"

biegsam
malleable
malléable
maleable

2,5 mm



1/1

Fig. 000

24869-30

3,2mm



Fig. 00

24869-20

3,6 mm



Fig. 0

24869-10

5,5 mm



Fig. 1

24869-1

6,7 mm



Fig. 2

24869-2

8 mm



Fig. 3

24869-3

11 mm



Fig. 4

24869-4

15 mm



Fig. 5

24869-5

Gallensteinlöffel
 Gall Stone Scoops
 Curettes pour calculs biliaires
 Cucharillas para cálculos biliares

Katheter-Einführungsinstrument
 Catheter introducing instrument
 Instrument pour introduire des sondes
 Instrumento para introducir catéteres

Katheter-Einführungsinstrument
 Catheter introducing instrument
 Instrument pour introduire des sondes
 Instrumento para introducir catéteres



SCHWERT
 SWORD · ESPADA
 EPEE · SPADA

Gallensteinlöffel, Gall Stone Scoops, Curettes pour calculs biliaires, Cucharillas para cálculos biliares



6 mm



Fig. 1

24850-1

7 mm



Fig. 2

24850-2

8 mm



Fig. 3

24850-3

9 mm



Fig. 4

24850-4

1/1

Desjardins
 30,0 cm/12"

federnd
 elastic
 élastique
 elástica



Moore
 24852
 28,0 cm/11"



Mayo
 24865
 28,0 cm/11"



Guyon
 25178
 36,5 cm/14½"



Blasenspatel
Bladder Retractors
Spatules vésicales
Separadores vesicales

SCHWERT
SWORD · ESPADA
EPEE · SPADA



35 mm

Legue

25355

27,0 cm/10½"



56 mm

Kocher

25356

26,0 cm/10¼"



67 mm

Kocher

25348

26,0 cm/10¼"

**Blasenwundspreizer
Bladder Retractors
Ecarteurs vésicaux
Separadores vesicales**



SCHWERT
SWORD · ESPADA
EPEE · SPADA



Judd-Masson

25339	110 mm	73x28 mm	73x28 mm
	Spreizweite	Seitliche Valven	Mittelvalve
	Spread	Lateral blades	Center blade
	Ecartement	Valves latérales	Valve centrale
	Apertura de la hoja	Valvas laterales	Valva central



Millin

25335 bestehend aus, consisting of
compose de, compuesto de:

25335-1 Sperrer, Spreader
Ecarteur, Separador

25335-5 57x25 mm Seitliche Valven
Lateral blades

25335-8 80x25 mm Valves latérales
Valvas laterales

25335-12 Mittelvalve, Center blade
120x45 mm Valve centrale, Valva central



Legueu

25342	95 mm	28x60 mm	70x32 mm
	Spreizweite	Seitliche Valven	Mittelvalve
	Spread	Lateral blades	Center blade
	Ecartement	Valves latérales	Valve centrale
	Apertura de la hoja	Valvas laterales	Valva central



SCHWERT
SWORD · ESPADA
EPEE · SPADA

Beschneidungsinstrumente
Circumcision Instruments
Instruments de circoncision
Instrumentes para circuncisión

Fremdkörperzangen
Foreign Body Forceps
Pincers à corps étrangers
Pinzas para cuerpos extraños



Beschneidungsinstrumente
Circumcision Instruments
Instruments de circoncision
Instrumentes para circuncisión

25210-16	16 mm
25210-21	21 mm
25210-26	26 mm
25210-32	32 mm

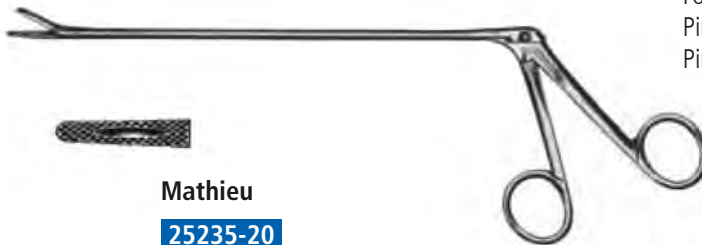

Fremdkörperzangen
Foreign Body Forceps
Pincers à corps étrangers
Pinzas para cuerpos extraños

Mathieu

25235-20

20,0 cm/8"

Penisklemmen
Penis Seizing Forceps
Compresseurs de l'urètre
Compresores uretrales



Strauss

25201

11,0 cm/4 1/2"



Stockmann

25200

8,0 cm/3 1/4"

Prostatahaken
Prostatic Retractors
Ecarteurs prostatiques
Separadores para prostata



SCHWERT
SWORD · ESPADA
EPEE · SPADA



Young

25301

21,5 cm/8½"



Young

25302

21,5 cm/8½"



Young

25303

22,0 cm/8¾"



Young

25304

21,5 cm/8½"



Kapsel­f­ass­z­an­gen
Capsule Forceps
Pinces pour saisir les capsules
Pinzas capsulares

SCHWERT
SWORD · ESPADA
EPEE · SPADA

atraumatisch
atraumatic
atraumatique
atraumática



1/1

25320

23,5 cm/9 1/4"



Millin



1/1

Fig. 1

25319

23,0 cm/9"



Fig. 2

25317

23,0 cm/9"

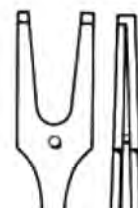

Fig. 3

25315

24,0 cm/9 1/2"



SCHWERT
SWORD · ESPADA
EPEE · SPADA

Rektum Instrumente Rectal Instruments Instruments Rectaux Instrumentes Rectales

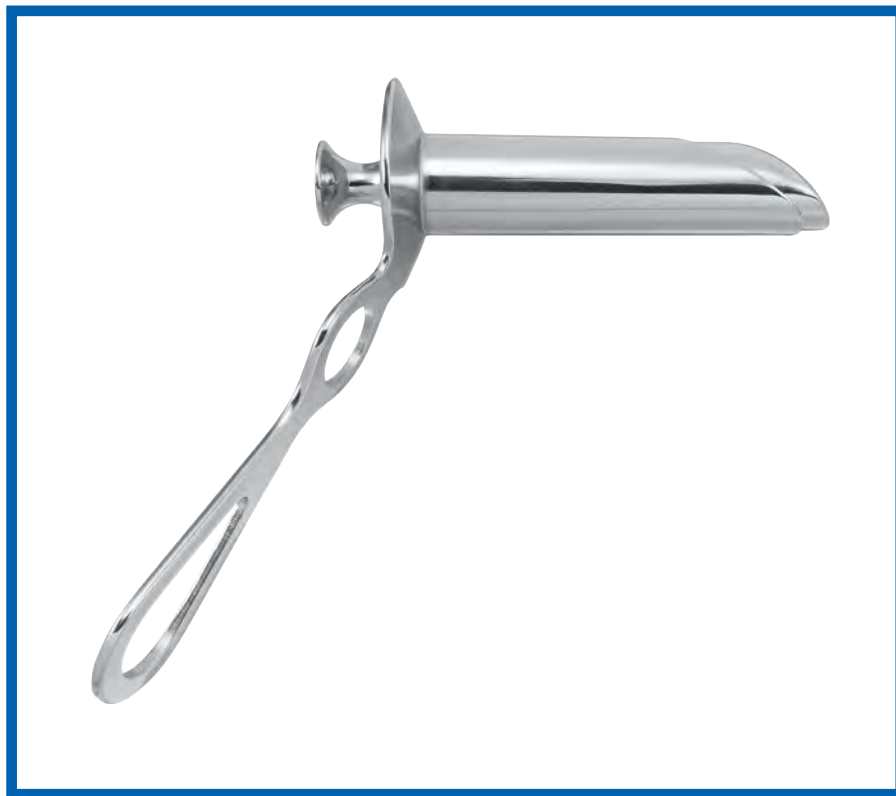



Hämorrhoidal-Fasszangen
Haemorrhoidal Forceps
Pinces pour saisir les hémorroïdes
Pinzas hemorroidales

SCHWERT
SWORD - ESPADA
EPEE - SPADA



McGivney

25469

19,0 cm/7½"



McGivney

25470

19,0 cm/7½"

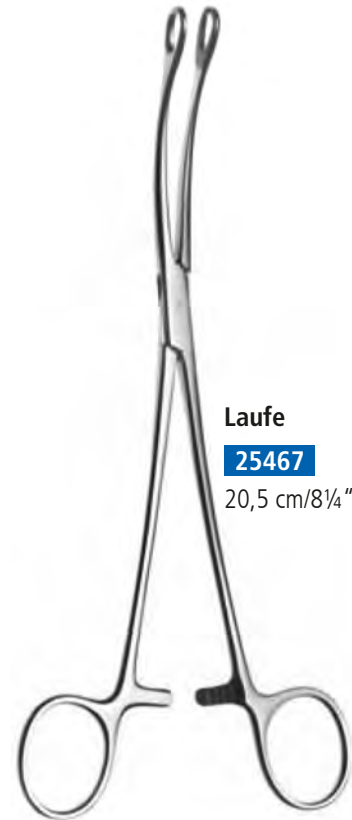

Laufe

25467

20,5 cm/8¼"

Anuskope
Anusopes
Anusopes
Anuscopios



SCHWERT
SWORD · ESPADA
EPEE · SPADA

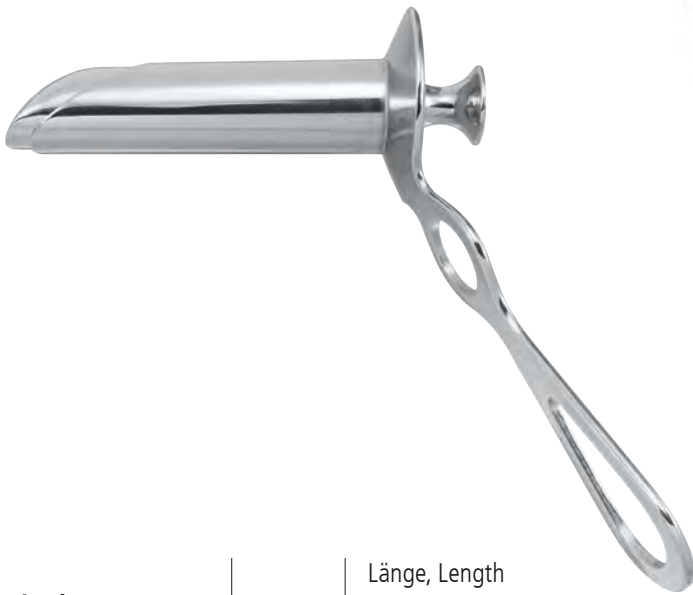

Hirschmann	Ø	Länge, Length Longeur, Largo
25579-16 Fig. 1	16 mm	x 6,5 cm/2½"
25579-19 Fig. 2	19 mm	x 6,5 cm/2½"
25579-22 Fig. 3	22 mm	x 6,5 cm/2½"



Ives-Fansler	Ø	Länge, Length Longeur, Largo
25585	22 mm	x 9,5 cm/4"



Proktoskope
Proctoscopes
Proctoscopes
Proctoscopios

SCHWERT
SWORD - ESPADA
EPEE - SPADA



Chelsea Eaton		Ø	Länge, Length Longeur, Largo
25559-1	Fig. 1	22 mm	x 6,5 cm/2½"
25559-2	Fig. 2	30 mm	x 6,5 cm/2½"



Kelly		Ø	Länge, Length Longeur, Largo
25561-0	Fig. 1	22 mm	x 5,0 cm/2"
25561	Fig. 2	22 mm	x 10,0 cm/4"
25562	Fig. 3	22 mm	x 14,5 cm/6"
25563	Fig. 4	22 mm	x 20,0 cm/8"

Sphinkteroskope
Sphincteroscopes
Sphinctérosopes
Esfincteroscopios

Mastdarm-Spekula
Rectal Specula
Spéculums rectaux
Espéculos rectales



SCHWERT
SWORD · ESPADA
EPEE · SPADA

Sphinkteroskope
Sphincteroscopes
Sphinctérosopes
Esfincteroscopios



Kelly		Ø	Länge, Length Longeur, Largo
25555	Fig. 3	21 mm	x 5,0 cm/2"
25556	Fig. 4	25 mm	x 5,0 cm/2"



70x22 mm

Mastdarm-Spekula
Rectal Specula
Spéculums rectaux
Espéculos rectales

Barr

25540

17,0 cm/6¾"



Analpreizer
Anal Retractors
Ecarteurs rectaux
Separadores rectales

SCHWERT
SWORD · ESPADA
EPEE · SPADA



Analpreizer

25590

18,0 cm/7"

15/30 x 70 mm

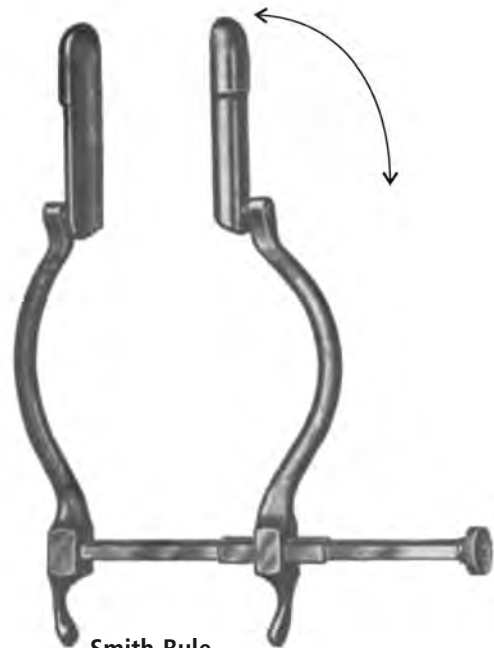

Smith-Bule

25542

15,0 cm/6"

**Analspreizer
Anal Retractors
Ecarteurs rectaux
Separadores rectales**



SCHWERT
SWORD · ESPADA
EPEE · SPADA



Alan Parks

25538

13,5 cm/5¼"

bestehend aus:
consisting of:
compose de :
compuesto de:

25538-1

25538-2

25538-3 2x

25538-4 2x



25538-1

Sperrer, allein
Spreader, only
Ecarteur, seule
Separador, suelta

25538-2 95x24 mm

Mittelblatt, allein
Center blade, only
Valve centrale, seule
Valva central, suelta

25538-2 75x24 mm

Blatt, allein
Blade, only
Valve, seule
Valva, suelta

25538-4 95x24 mm

Blatt, allein
Blade, only
Valve, seule
Valva, suelta



SCHWERT
SWORD · ESPADA
EPEE · SPADA

Mastdarm-Spekula
Rectal Specula
Spéculums rectaux
Espéculos rectales



Czerny

25517

22,0 cm/8¾"

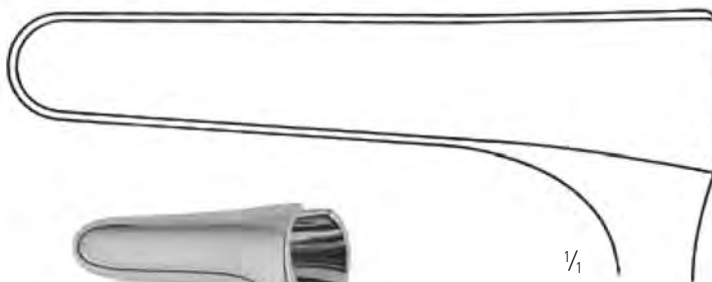

Sims
(Bodenhammer)

25524

15,0 cm/6"

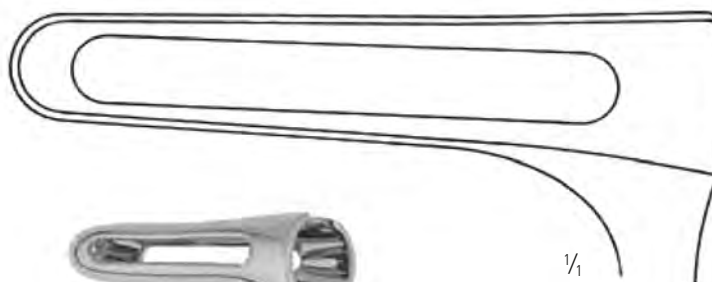

Sims

25525

15,0 cm/6"

Mastdarm-Spekula
Rectal Specula
Spéculums rectaux
Espéculos rectales



SCHWERT
SWORD · ESPADA
EPEE · SPADA

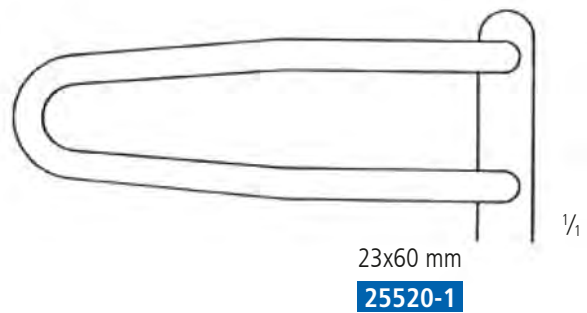
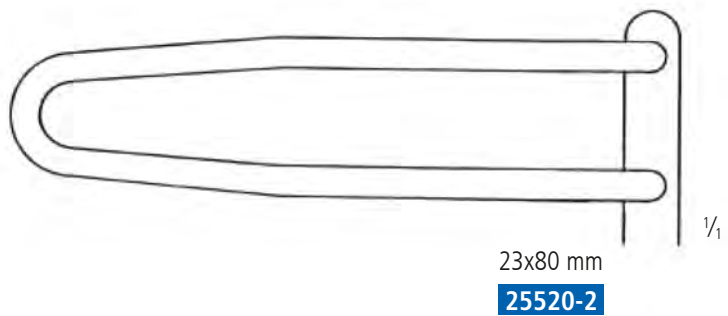
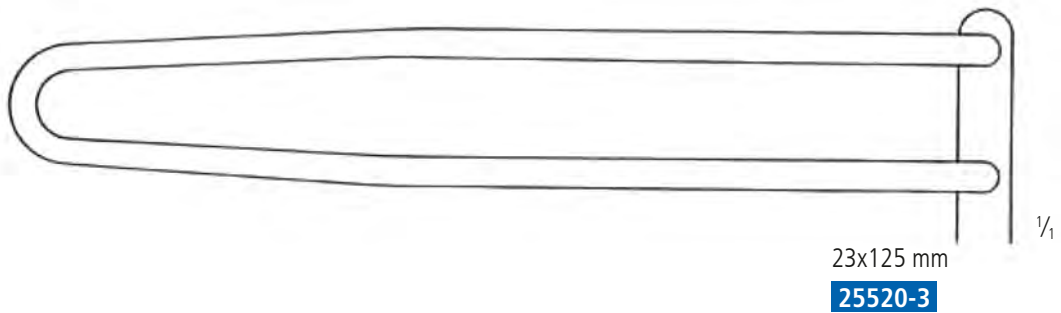
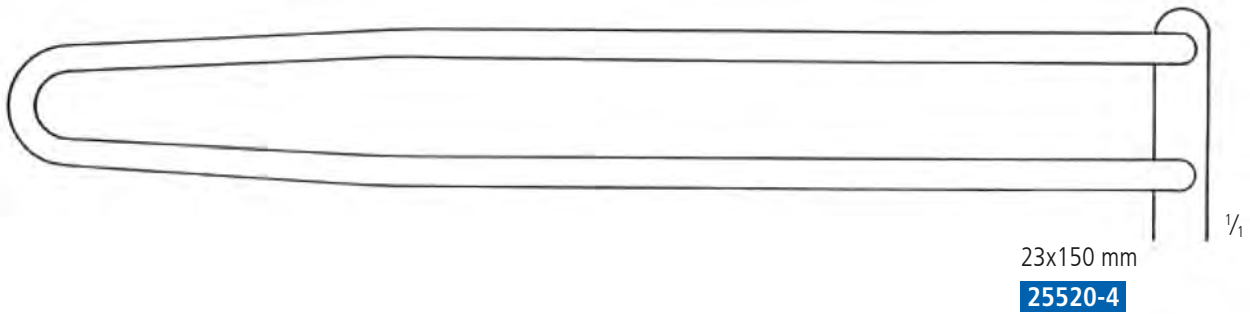

Sims

	Gesamtlänge Total length Longeur totale Largo total
25520-4	24,0 cm/9½"
25520-3	24,0 cm/9½"
25520-2	24,0 cm/9½"
25520-1	17,0 cm/6¾"



Mastdarm-Biopsiezangen
Rectal Biopsy Specimen Forceps
Pinces à biopsie rectale
Pinzas para biopsia rectal

SCHWERT
SWORD · ESPADA
EPEE · SPADA

— Schaftlänge · Length of shaft · Longueur de tige · Largo del asta —



Fig. 1



3,5x14 mm

Yeoman

27180-128 28,0 cm/11"

27180-135 35,0 cm/13¾"

27180-142 42,0 cm/16½"

Fig. 2



3,5x14 mm

Yeoman

27180-228 28,0 cm/11"

27180-235 35,0 cm/13¾"



27180-242 42,0 cm/16½"

Mastdarm-Biopsiezangen
Rectal Biopsy Specimen Forceps
Pinces à biopsie rectale
Pinzas para biopsia rectal

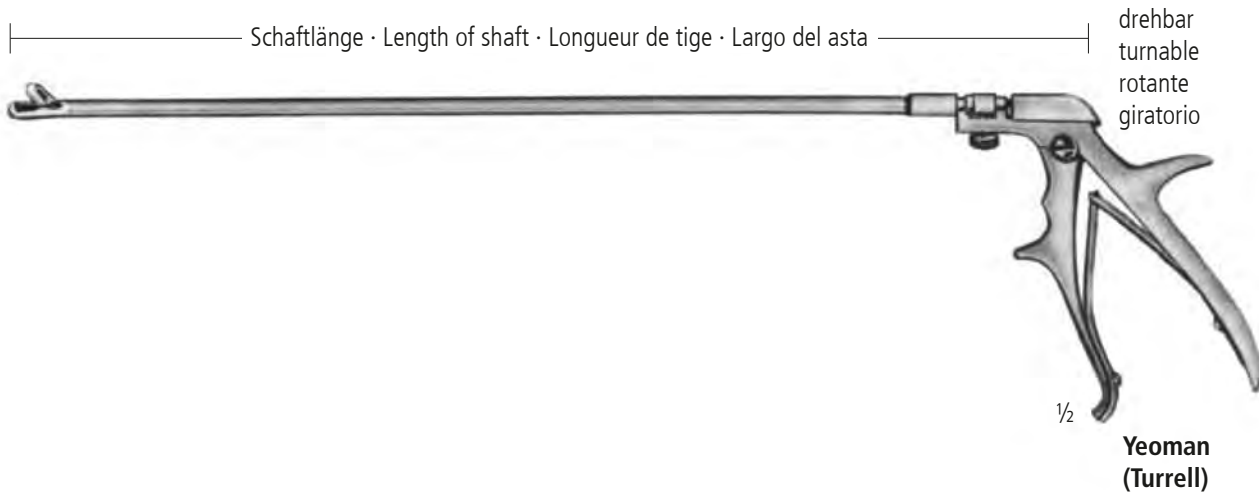

SCHWERT
 SWORD · ESPADA
 EPEE · SPADA



	$\frac{1}{4}$	Zange komplett mit Griff Forceps complete with handle Pince complète avec manche Pinza completa con mango	Schaftlänge Length of shaft Longueur de tige Largo del asta
10x3,5 mm Fig. 1 		27176-11	33 cm/13"
ohne Zähne, without teeth sans dents, sin dientes		27176-12	40 cm/16"
10x3,5 mm Fig. 2 		27176-21	33 cm/13"
ohne Zähne, without teeth sans dents, sin dientes		27176-22	40 cm/16"



SCHWERT
SWORD · ESPADA
EPEE · SPADA

Sonden
Directors
Sondes rectaux
Sondas rectales

Saugrohre
Suction Tubes
Tubes d'aspiration
Canulas de aspiración

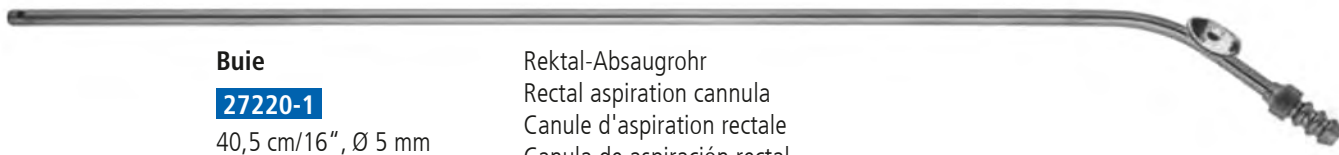

Buie

27220-1

40,5 cm/16", Ø 5 mm

Rektal-Absaugrohr
Rectal aspiration cannula
Canule d'aspiration rectale
Canula de aspiración rectal

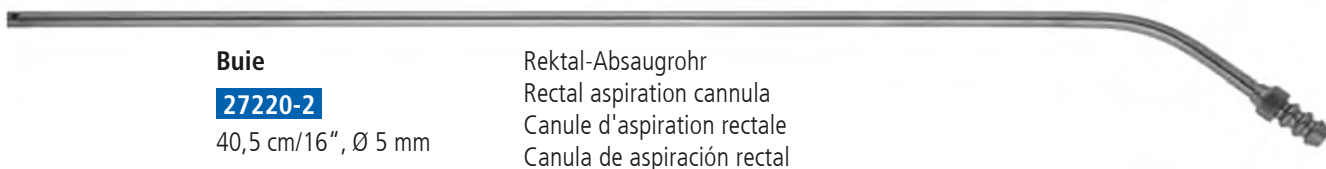

Buie

27220-2

40,5 cm/16", Ø 5 mm

Rektal-Absaugrohr
Rectal aspiration cannula
Canule d'aspiration rectale
Canula de aspiración rectal



Larry

27224-15

15,0 cm/6"
biegsam, malleable
malléable, maleable

Rektal-Sonde
Rectal director
Sonde rectale
Sonda rectal

Rektal-Schnürer
Rectal snares
Serre-noeuds rectaux
Cierre-nudos rectales

Watte- und Tupferträger
Cotton Applicators
Porte-cotons
Porta-algodones



SCHWERT
SWORD · ESPADA
EPEE · SPADA

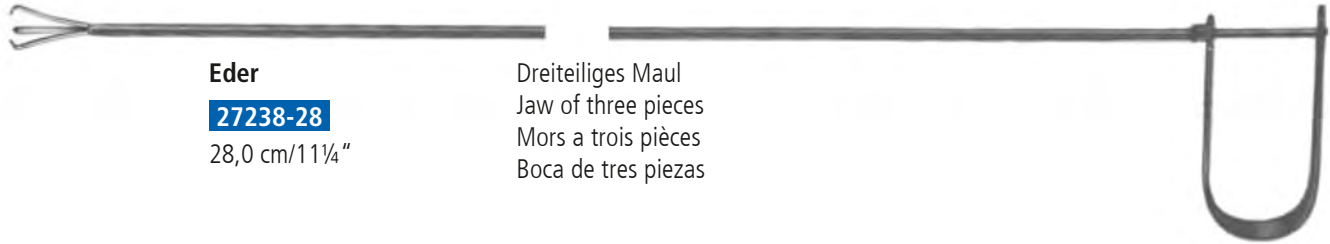

Eder

27238-28

28,0 cm/11¼"

Dreiteiliges Maul
Jaw of three pieces
Mors a trois pièces
Boca de tres piezas

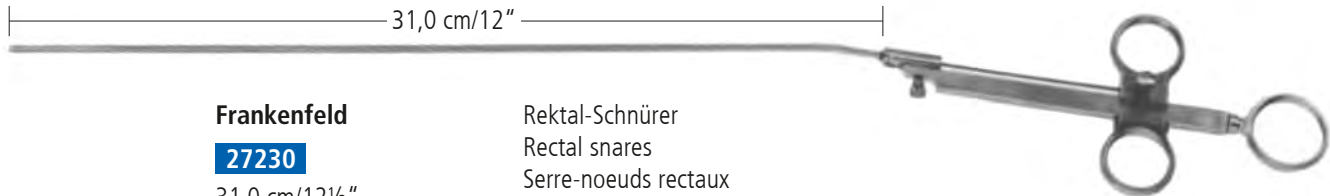

Frankenfeld

27230

31,0 cm/12½"

Rektal-Schnürer
Rectal snares
Serre-noeuds rectaux
Cierre-nudos rectales



27230-03

15,0 cm/6"

Pack a 12 Stück
Pack of 12 pieces
Paquet à 12 pièces
Paquete con 12 piezas

Stahldraht für Rektalschnürer
Steel wire for rectal snares
Anses en fil d'acier pour serre-noeuds rectaux
Alambre de acero para cierre-nudos rectales



SCHWERT
SWORD · ESPADA
EPEE · SPADA

Gynäkologie, Geburtshilfe
Gynecology, Obstetrics
Gynécologie, Accouchement
Ginecología, Obstetricia



Scheidenspekula
Vaginal Specula
Spéculums vaginaux
Espéculos vaginales



SCHWERT
SWORD · ESPADA
EPEE · SPADA



Kristeller

Satz für Kinder
Set for children
Jeu pour enfants
Juego para niños

25884-0 70x15 mm



Spekula
Specula
Spéculum
Espéculo

Halter
Retractor
Valve
Valva

Kristeller

kurzes Modell
short model
modèle court
modelo corto

Satz aus je 1 Spekula und 1 Halter
Set of 1 specula and 1 retractor
Jeu de 1 spéculum et 1 valve
Juego de 1 espéculo y 1 valva

Fig. 1 **25884-1**

Fig. 2 **25884-2**

Fig. 3 **25884-3**

Spekula
Specula
Spéculum
Espéculo

Fig. 1 **25878-1** 70x27 mm

Fig. 2 **25878-2** 80x30 mm

Fig. 3 **25878-3** 90x36 mm

Halter
Retractor
Valve
Valva

Fig. 1 **25880-1** 75x23 mm

Fig. 2 **25880-2** 85x26 mm

Fig. 3 **25880-3** 100x32 mm



SCHWERT
SWORD · ESPADA
EPEE · SPADA

Scheidenspekula Vaginal Specula Spéculums vaginaux Espéculos vaginales



Spekula
Specula
Spéculum
Espéculo

Halter
Retractor
Valve
Valva

Satz aus je 1 Spekula und 1 Halter
Set of 1 specula and 1 retractor
Jeu de 1 spéculum et 1 valve
Juego de 1 espéculo y 1 valva

Fig. 00 [25884-10](#)

Fig. 0 [25884-11](#)

Spekula
Specula
Spéculum
Espéculo

Fig. 00 [25878-10](#) 105x16 mm

Fig. 0 [25878-11](#) 105x21 mm

Halter
Retractor
Valve
Valva

Fig. 00 [25880-10](#) 110x14 mm

Fig. 0 [25880-11](#) 110x17 mm

Kristeller

mit konisch verlaufenden Blättern
with conically shaped blades
avec valves coniques
con valvas cónicas



Spekula
Specula
Spéculum
Espéculo

Halter
Retractor
Valve
Valva

Satz aus je 1 Spekula und 1 Halter
Set of 1 specula and 1 retractor
Jeu de 1 spéculum et 1 valve
Juego de 1 espéculo y 1 valva

Fig. 1 [25884-5](#)

Fig. 2 [25884-6](#)

Fig. 3 [25884-7](#)

Spekula
Specula
Spéculum
Espéculo

Fig. 1 [25878-5](#) 105x26 mm

Fig. 2 [25878-6](#) 105x28 mm

Fig. 3 [25878-7](#) 105x33 mm

Halter
Retractor
Valve
Valva

Fig. 1 [25880-5](#) 115x22 mm

Fig. 2 [25880-6](#) 115x24 mm

Fig. 3 [25880-7](#) 115x29 mm

Kristeller

langes Modell
long model
modèle longue
modelo largo

Scheidenspekula
Vaginal Specula
Spéculums vaginaux
Espéculos vaginales



SCHWERT
SWORD · ESPADA
EPEE · SPADA

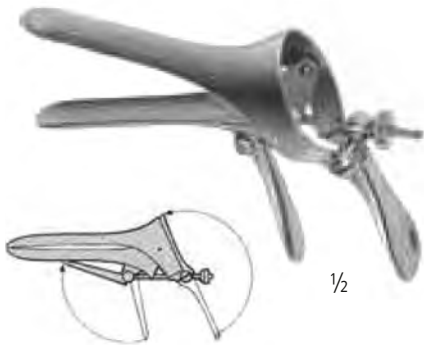

Cusco

25776-0 85x17 mm

für Jungfrauen
for virgins
pour vierges
para virgenes

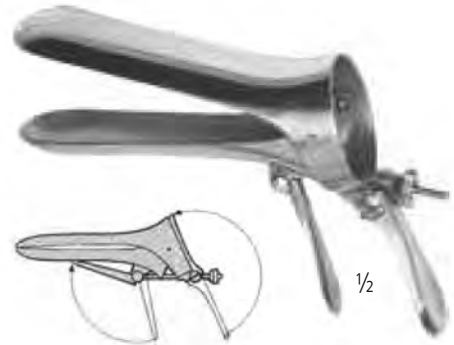

Cusco

Fig. 1 25776-1 75x32 mm

Fig. 2 25776-2 85x35 mm

Fig. 3 25776-3 100x35 mm

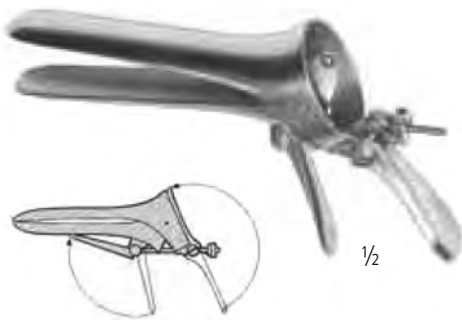

Cusco

Fig. 2 25775-2 100x25/27 mm

Fig. 3 25775-3 100x27/30 mm

Schweizer Modell
Swiss pattern
Modèle suisse
Modelo suizo



Grave

Fig. 1 25798-1 75x20 mm

Fig. 2 25798-2 95x30 mm

Fig. 3 25798-3 105x33 mm



SCHWERT
SWORD - ESPADA
EPEE - SPADA

Scheidenspekula Vaginal Specula Spéculums vaginaux Espéculos vaginales



Seyffert
23,0 cm/9"

25802-1 100x17 mm

25802-2 110x33 mm



Collin

Fig. 1 **25791-1** 90x29 mm

Fig. 2 **25791-2** 95x35 mm

Fig. 3 **25791-3** 110x40 mm



Pederson

Fig. 1 **25799-1** 75x13 mm

Fig. 2 **25799-2** 100x22 mm

Fig. 3 **25799-3** 130x25 mm

Scheidenspekula
Vaginal Specula
Spéculums vaginaux
Espéculos vaginales



SCHWERT
SWORD · ESPADA
EPEE · SPADA



1/2

Semm

- Fig. 1 **25803-1** 95x14/18 mm
Fig. 2 **25803-2** 100x20/25 mm
Fig. 3 **25803-3** 105x27/35 mm

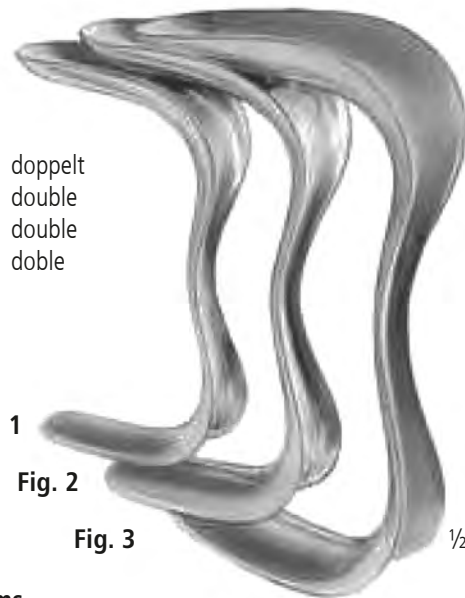

doppelt
double
double
double

Fig. 1

Fig. 2

Fig. 3

1/2

Sims

- Fig. 1 **25855-1** 70x25/75x30 mm
Fig. 2 **25855-2** 75x30/80x35 mm
Fig. 3 **25855-3** 80x35/90x40 mm



Spekula
Specula
Spéculum
Espéculo

1/2

Halter
Retractor
Valve
Valva

1/2

Kallmorgen

Satz aus je 1 Spekula und 1 Halter
Set of 1 specula and 1 retractor
Jeu de 1 spéculum et 1 valve
Juego de 1 espéculo y 1 valva

Fig. 1 **25888-A** 17,0 cm/6¾"

Fig. 2 **25888-B** 20,0 cm/8"

- Fig. 1 **25888-11** 70x40 mm
Fig. 2 **25888-12** 90x40 mm

- Fig. 1 **25888-1** 70x33 mm
Fig. 2 **25888-2** 90x33 mm



Scheidenspekula
Vaginal Specula
Spéculums vaginaux
Espéculos vaginales

SCHWERT
SWORD · ESPADA
EPEE · SPADA



Breisky

1/2

29,0 cm/11½"

- 25915-1** 100x20 mm
- 25915-2** 100x25 mm
- 25915-3** 100x30 mm
- 25915-4** 100x35 mm
- 25915-5** 100x40 mm

32,0 cm/12½"

- 25915-11** 130x20 mm
- 25915-12** 130x25 mm
- 25915-13** 130x30 mm
- 25915-14** 130x35 mm
- 25915-15** 130x40 mm

35,0 cm/13¾"

- 25915-16** 155x20 mm



Doyen

24,0 cm/9½"

- 25928** 70x30 mm

1/2

Scheidenspekula
Vaginal Specula
Spéculum vaginaux
Espéculos vaginales



SCHWERT
SWORD · ESPADA
EPEE · SPADA



Spekula
Specula
Spéculum
Espéculo

Halter
Retractor
Valve
Valva

Mathieu
21,0 cm/8¼"

Spekula
Specula
Spéculum
Espéculo

25890-12 95x17-30 mm

Halter
Retractor
Valve
Valva

25891-2 95x17-26 mm

½



Doyen

Fig. 1 **25892-1A** 60x35 mm

Fig. 2 **25892-1B** 90x35 mm

Fig. 3 **25892-1C** 120x35 mm

Fig. 4 **25892-1D** 160x35 mm

Fig. 1 **25892-2A** 60x45 mm

Fig. 2 **25892-2B** 90x45 mm

Fig. 3 **25892-2C** 120x45 mm

Fig. 4 **25892-2D** 160x45 mm

Fig. 1 **25892-3A** 60x60 mm

Fig. 2 **25892-3B** 90x60 mm

Fig. 3 **25892-3C** 120x60 mm

Fig. 4 **25892-3D** 160x60 mm



SCHWERT
SWORD - ESPADA
EPEE - SPADA

Lateral Vaginal-Retractor
Lateral Vaginal Retractor
Spéculum lateral
Espéculos laterales

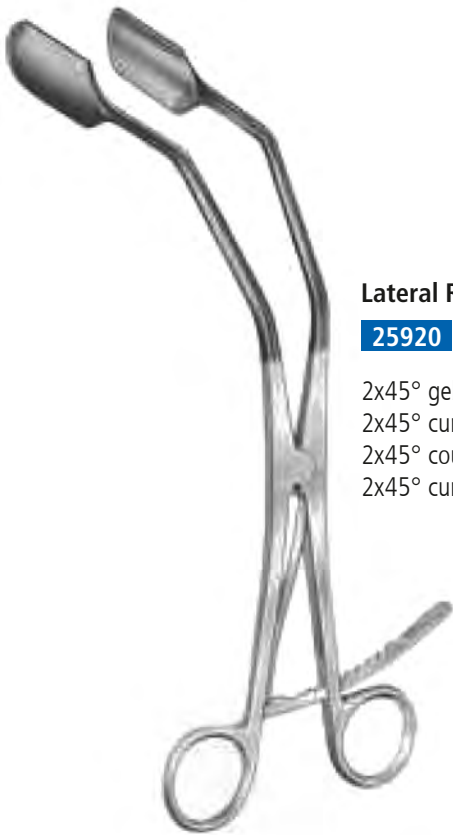

Lateral Retraktor

25920

2x45° gebogen
2x45° curved
2x45° courbe
2x45° curva

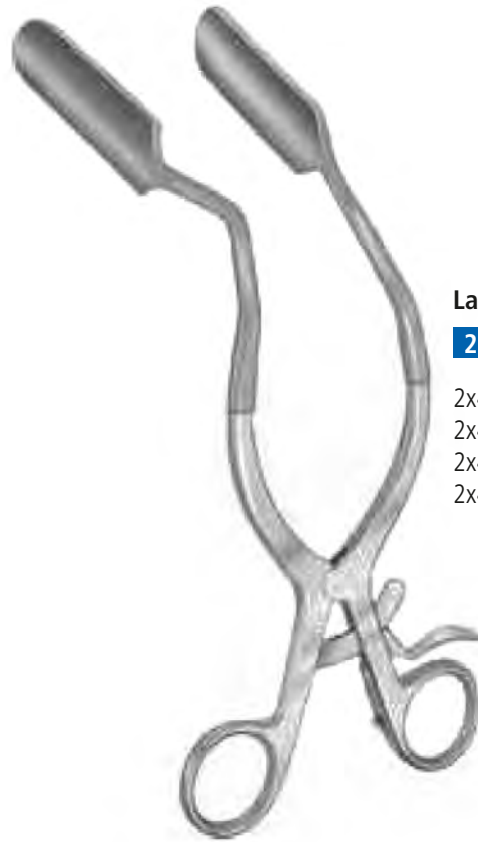

Lateral Retraktor

25921

2x45° gebogen
2x45° curved
2x45° courbe
2x45° curva



Der Lateral Vaginal-Retraktor erweitert Ihr Blickfeld und den Arbeitsbereich.

The Lateral Vaginal Retractor improves access and viewing of the cervix during a procedure.

Le spéculum latéral élargit votre angle visuel et votre sphère du travail.

El espéculo lateral amplía su campo visual y su zona de trabajo.

Scheidenspekula
Vaginal Specula
Spéculums vaginaux
Espéculos vaginales



SCHWERT
 SWORD · ESPADA
 EPEE · SPADA

75x38 mm



Auvard

25825

mit abnehmbaren Gewicht
 with detachable weight
 avec poids démontable
 con peso desmontable

25826

mit festem Gewicht
 with fixed weight
 avec poids fixe
 con peso fijo

Scherbak

25832

Satz bestehend aus Gewicht (25832-14), Griff und 5 Blättern
 Set consisting of weight (25832-14), handle and 5 blades
 Jeu composé de poids (25832-14), manche et 5 valves
 Juego compuesto de peso (25832-14), mango y 5 valvas

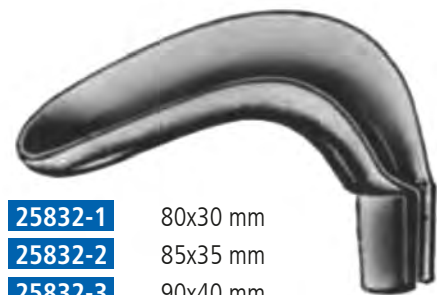

25832-1

80x30 mm

25832-2

85x35 mm

25832-3

90x40 mm

25832-10

Griff allein
 Handle only
 Manche seul
 Mango suelto

25832-14 400 g

25832-18 800 g

Gewicht allein
 Weight only
 Poids seul
 Peso suelto



25832-4

55x40/60 mm

25832-5

70x45/70 mm



Endospekula
Endospecula
Endospéculums
Endospéculos

SCHWERT
SWORD · ESPADA
EPEE · SPADA



Kogan
28 cm/11"

mit Sperre
with ratchet
avec crémaillère
con cremallera



4x23 mm

25835-2



3x23 mm

25835-1

6x23 mm

25835-3

Endospekula
Endospecula
Endospéculum
Endospéculos



SCHWERT
SWORD · ESPADA
EPEE · SPADA

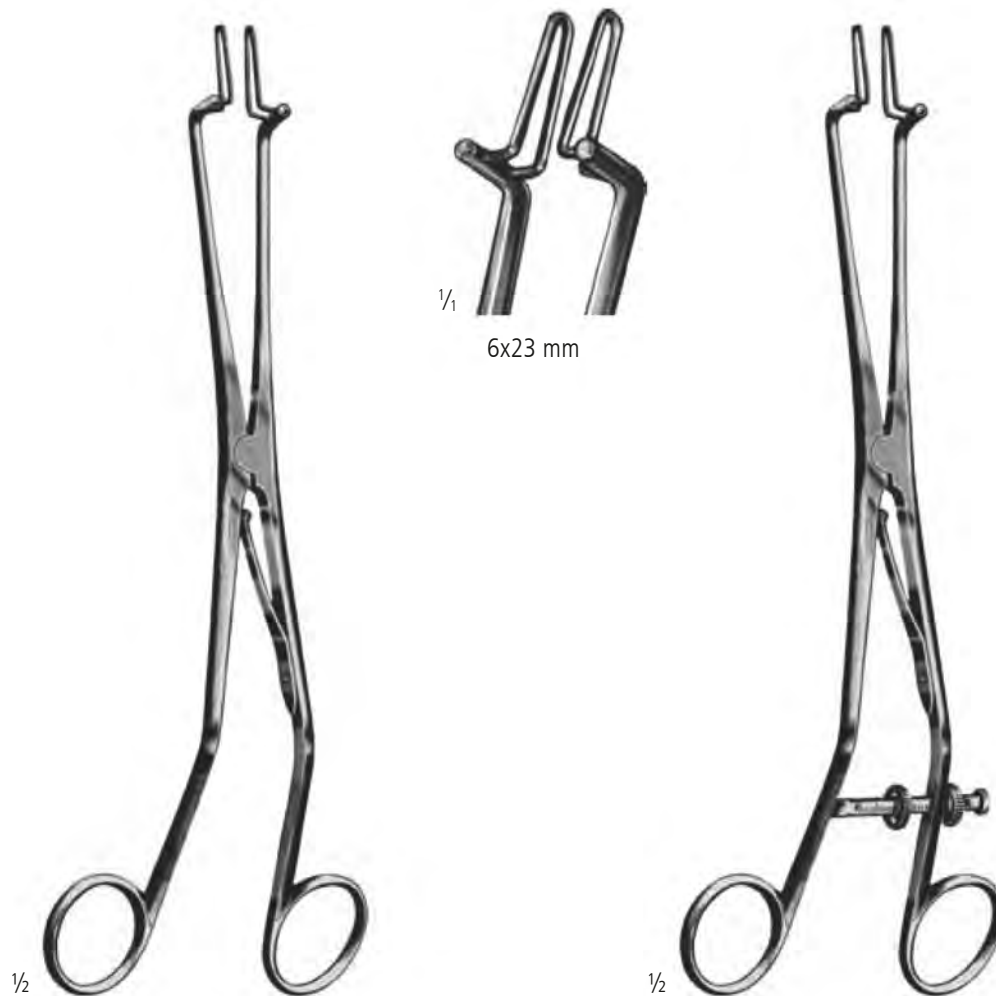

Kogan

25836-3

24 cm/9½"

ohne Sperre
without ratchet
sans crémaillère
sin cremallera

Kogan

25837-3

24 cm/9½"

mit Schraubensperre
with screw ratchet
avec crémaillère de vis
con cremallera de tornillo



SCHWERT
SWORD · ESPADA
EPEE · SPADA

**Uterusdilatoren
Uterine-Dilators
Dilatateurs utérins
Dilatadores uterines**



Hegar

mit glattem Muldengriff
with sloped handle
avec manche aplati
con mango aplanado

	mm		mm
25973-1	1	25973-1,5	1,5
25973-2	2	25973-2,5	2,5
25973-3	3	25973-3,5	3,5
25973-4	4	25973-4,5	4,5
25973-5	5	25973-5,5	5,5
25973-6	6	25973-6,5	6,5
25973-7	7	25973-7,5	7,5
25973-8	8	25973-8,5	8,5
25973-9	9	25973-9,5	9,5
25973-10	10	25973-10,5	10,5
25973-11	11	25973-11,5	11,5
25973-12	12	25973-12,5	12,5
25973-13	13	25973-13,5	13,5
25973-14	14	25973-14,5	14,5
25973-15	15	25973-15,5	15,5
25973-16	16	25973-16,5	16,5
25973-17	17	25973-17,5	17,5
25973-18	18	25973-18,5	18,5
25973-19	19	25973-19,5	19,5
25973-20	20	25973-20,5	20,5
25973-21	21	25973-21,5	21,5
25973-22	22	25973-22,5	22,5
25973-23	23	25973-23,5	23,5
25973-24	24		
25973-25	25		
25973-26	26		
25973-27	27		
25973-28	28		
25973-29	29		
25973-30	30		

Satz		Stück per Satz
Set		Pieces per set
Jeu		Pièces par jeu
Juego	mm	Piezas por juego
25973-PL14	4-17	14
25973-PL26	1-26	26

**Uterusdilatoren
Uterine-Dilators
Dilatateurs utérins
Dilatadores uterines**



SCHWERT
SWORD · ESPADA
EPEE · SPADA



Hegar

mit glattem Muldengriff in Ledertasche
with sloped handle in leather pouch
avec manche aplati en pochette de cuir
con mango aplanado en estuche de cuero

Satz		Stück per Satz
Set		Pieces per set
Jeu		Pièces par jeu
Juego	mm	Piezas por juego
25973-L14	4-17	14



SCHWERT
SWORD · ESPADA
EPEE · SPADA

Uterusdilatoren Uterine-Dilators Dilatateurs utérins Dilatadores uterines

Hegar

doppelt
double
double
doble



	mm
25980-1	1/2
25980-3	3/4
25980-5	5/6
25980-7	7/8
25980-9	9/10
25980-11	11/12
25980-13	13/14
25980-15	15/16
25980-17	17/18
25980-19	19/20
25980-21	21/22
25980-23	23/24
25980-25	25/26

Satz Set Jeu Juego	mm	Stück per Satz Pièces per set Pièces par jeu Piezas por juego
25980-PL8	3/4-17/18	8
25980-PL13	1/2-25/26	13



Hank

Amerikanische Skala
American scale
Echelle américaine
Escala americana

		mm
Fig. 9/10	25984-9	9/10
Fig. 11/12	25984-11	11/12
Fig. 13/14	25984-13	13/14
Fig. 15/16	25984-15	15/16
Fig. 17/18	25984-17	17/18
Fig. 19/20	25984-19	19/20



Hegar

doppelt, double, double, doble

in Stofftasche, in canvas roll,
en pochette à toile, en estuche de tela

Satz Set Jeu Juego	mm	Stück per Satz Pièces per set Pièces par jeu Piezas por juego
25980-S8	3/4-17/18	8

Satz Set Jeu Juego	mm	Stück per Satz Pièces per set Pièces par jeu Piezas por juego
25984-6	9/10-17/18	6

Uterussonden
Uterine Sounds
Hystéromètres
Histerómetros

Uterus-Depressoren
Uterine depressors
Depresseurs utérins
Depresores uterines



SCHWERT
SWORD · ESPADA
EPEE · SPADA



Uterussonden
Uterine Sounds
Hystéromètres
Histerómetros

Sims

32,0 cm/12½"

26010

starr, graduiert in cm
rigid, graduated in cm
rigide, gradué en cm
rigido, graduado en cm

26010-1

biegsam, graduiert in cm
malleable, graduated in cm
malléable, gradué en cm
maleable, graduado en cm



biegsam
malleable
malléable
maleable

Martin

26014

32,0 cm/12½"



Uterus-Depressor
Uterine depressor
Depresseur utérin
Depresor uterin0

Braun

26035

27,5 cm/11"



SCHWERT
SWORD · ESPADA
EPEE · SPADA

Hakenzangen
Tenaculum Forceps
Pinces à griffes
Pinzas para coger el cuello del útero



s-förmig
S-shaped
forme en S
en forme de S

Duplay
25,0 cm/10"

26321



spitz
sharp
pointue
aguda

26282

Isoliert für Laser- und Elektrochirurgie
Insulated for Laser- and Electrosurgery
Isolé pour les interventions au laser et électrochirurgical
Aislado para láser y electrocirugía

Schröder-Braun
25,0 cm/10"



stumpf
blunt
mousse
roma

26283



Braun
25,0 cm/10"

26280



Skene
24,0 cm/9½"

26325

Hakenzangen
Tenaculum Forceps
Pincers à griffes
Pinzas para coger el cuello del útero



SCHWERT
SWORD · ESPADA
EPEE · SPADA



Staude-Moore
17,0 cm/6¾"

26315



Czerny
20,0 cm/8"

26316

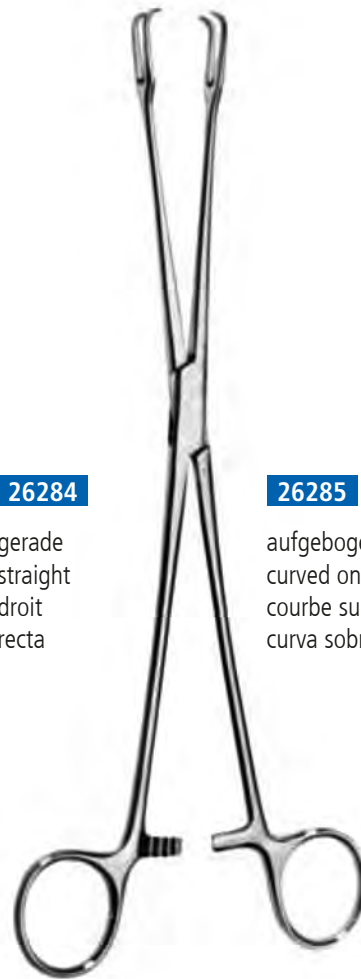

26284

gerade
straight
droit
recta

26285

aufgebogen
curved on flat
courbe sur le plat
curva sobre el plano

Schröder
24,0 cm/9½"



SCHWERT
SWORD - ESPADA
EPEE - SPADA

Hakenzangen
Tenaculum Forceps
Pinces à griffes
Pinzas para coger el cuello del útero



Teale
23,0 cm/9"

26333

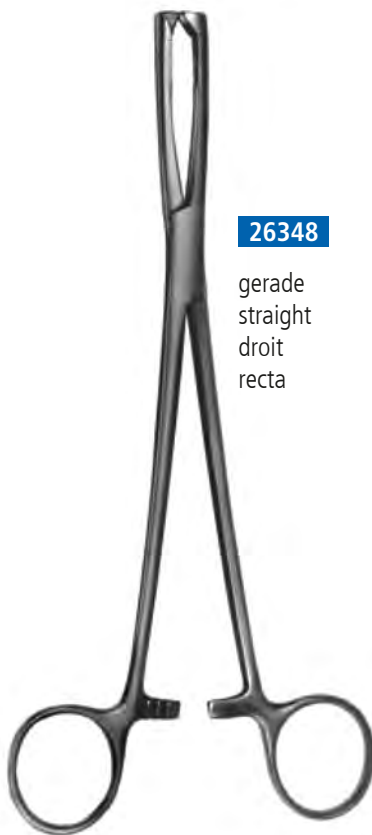

Jakobs
21,0 cm/8½"

26348

gerade
straight
droit
recta

26350

aufgebogen
curved on flat
courbe sur le plat
curva sobre el plano

26349

seitwärts gebogen
curved sideways
courbe sur le côté
curva lateral

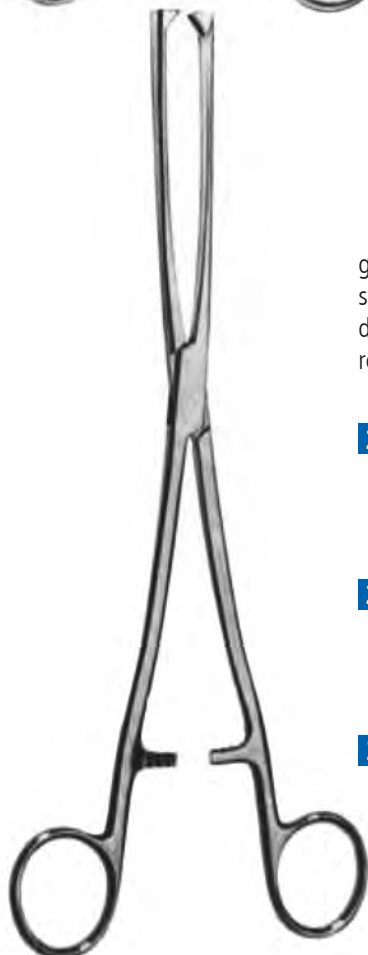

gerade
straight
droit
recta

26364-6

6 mm



seitwärts gebogen
curved sideways
courbe sur le côté
curva lateral

26365-6

8 mm



26364-8

26365-8

10 mm



26364-10

26365-10

Museux
24,0 cm/9½"

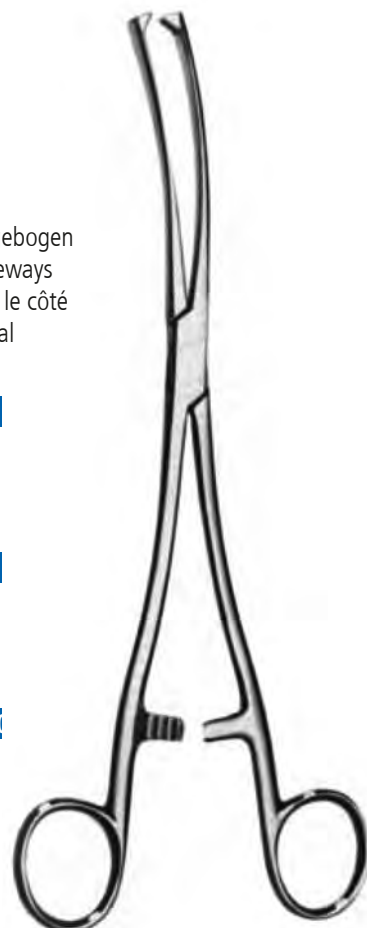

Uterus-Polypenzangen
Uterine Polypus Forceps
Pinces à polypes utérins
Pinzas para polipos uterines

Uterus-Fasszangen
Uterine Elevating Forceps
Pinces hystérolabes
Pinzas para el útero



SCHWERT
SWORD · ESPADA
EPEE · SPADA

Uterus-Polypenzangen, Uterine Polypus Forceps
Pinces à polypes utérins, Pinzas para polipos uterines



Noto

26225

27,0 cm/10½"



Kelly

26237

32,0 cm/12½"

Ovarien-Fasszange
Ovarian Elevating Forceps
Pinces pour les ovaires
Pinzas para ovarios



Doyen

26448

20,0 cm/8"



SCHWERT
SWORD · ESPADA
EPEE · SPADA

Uterus-Fasszangen
Uterine Elevating Forceps
Pinces hystérolabes
Pinzas para el útero

Myomheber
Myoma Screw
Tracteur de fibrome
Tiramiomas



Dartigues

26420

27,0 cm/10½"



Myomheber
Myoma Screw
Tracteur de fibrome
Tiramiomas

Doyen

26844

17,0 cm/6¾"



Doyen

26842

17,0 cm/6¾"



Fasszangen
Grasping Forceps
Pincés pour saisir
Pinzas para coger



SCHWERT
SWORD · ESPADA
EPEE · SPADA

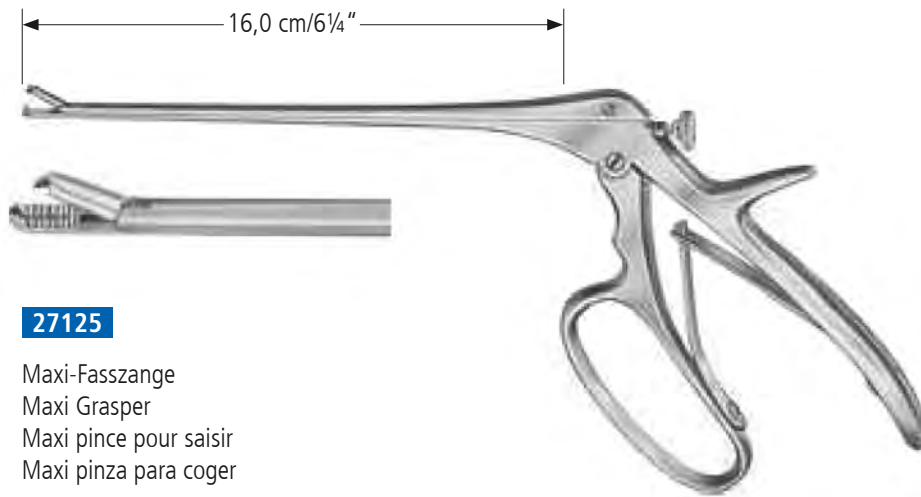

27125

Maxi-Fasszange
Maxi Grasper
Maxi pince pour saisir
Maxi pinza para coger

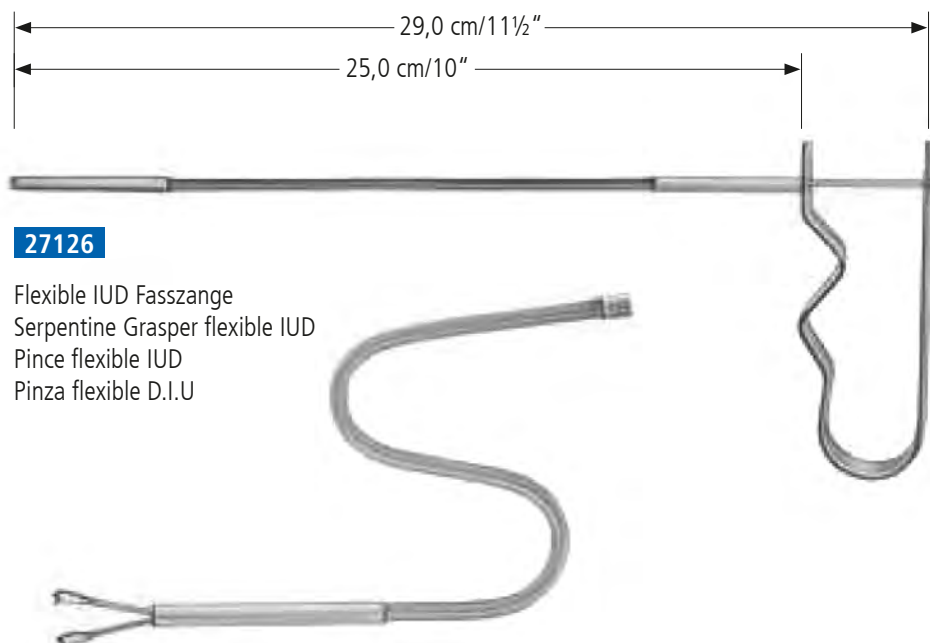

27126

Flexible IUD Fasszange
Serpentine Grasper flexible IUD
Pince flexible IUD
Pinza flexible D.I.U



SCHWERT
SWORD · ESPADA
EPEE · SPADA

Biopsiezangen
Biopsy Punches
Pinces emporte-pièces à biopsie
Pinzas para biopsia

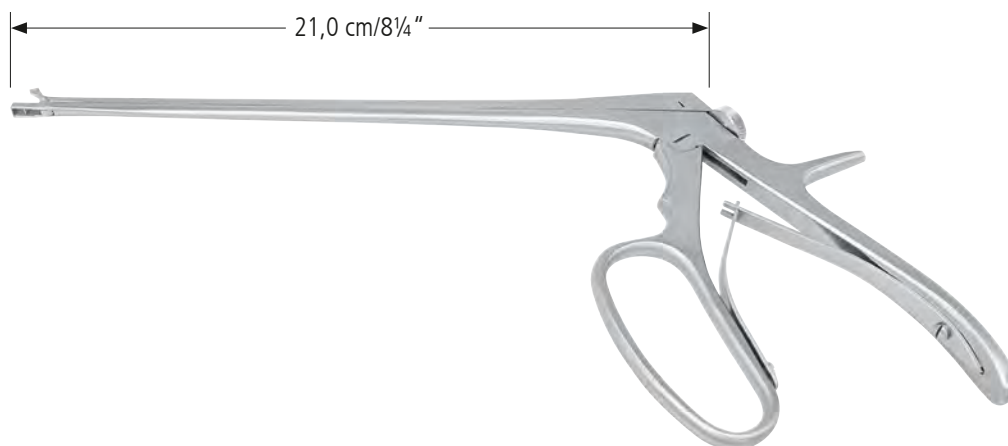

 3x9 mm
Tischler-Kevorkian
27128-1



 3x7 mm
Tischler
27128-2



 2,3x4 mm
Baby-Tischler
27128-3



 2,3x4 mm
Mini-Tischler
27128-4



 3x9 mm
Kevorkian
27128-5



 3x7 mm
Coppelson
27128-6

Biopsiezangen
Biopsy Punches
Pinces emporte-pièces à biopsie
Pinzas para biopsia

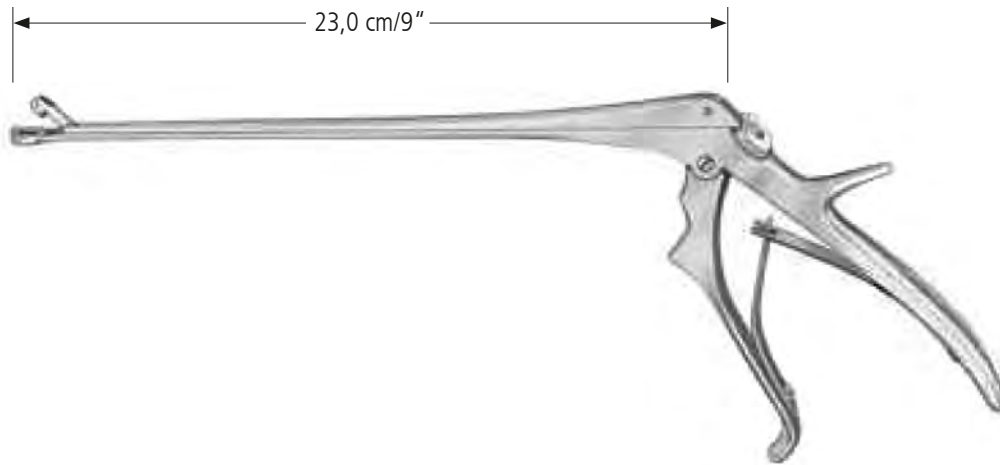

○ 3x5 mm

Burke

27129-1



○ 4x6,5 mm

Baggish

27129-2



SCHWERT
SWORD · ESPADA
EPEE · SPADA



SCHWERT
SWORD · ESPADA
EPEE · SPADA

Biopsiezangen
Biopsy Punches
Pinces emporte-pièces à biopsie
Pinzas para biopsia

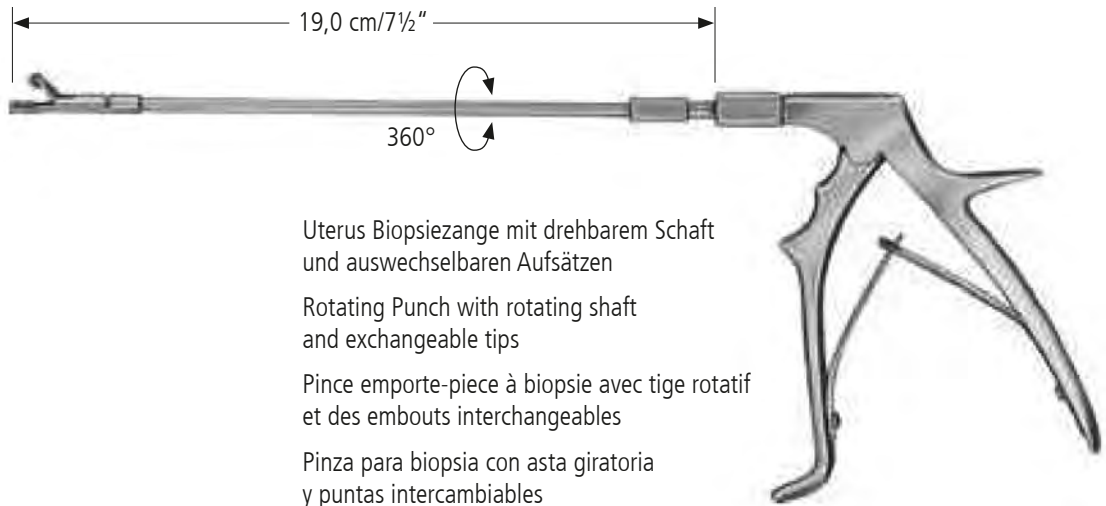

Uterus Biopsiezange mit drehbarem Schaft und auswechselbaren Aufsätzen

Rotating Punch with rotating shaft and exchangeable tips

Pince emporte-pièce à biopsie avec tige rotatif et des embouts interchangeables

Pinza para biopsia con asta giratoria y puntas intercambiables

komplett · complete · complet · completo



○ 3x7 mm

Uni-Tischler komplett, complete
complet, completo

27130-1
gerade, straight
droit, recta



○ 3x7 mm

Uni-Tischler komplett, complete
complet, completo

27130-2
abwärts gebogen, downwards curved
courbe vers le bas, curva hacia abajo



○ 3x7 mm

Uni-Tischler komplett, complete
complet, completo

27130-3
aufwärts gebogen, upwards curved
courbe vers le haut, curva hacia arriba



□ 2,3x4 mm

Uni-Townsend komplett, complete
complet, completo

27130-4
gerade, straight
droit, recta



□ 2,3x4 mm

Uni-Townsend komplett, complete
complet, completo

27130-5
abwärts gebogen, downwards curved
courbe vers le bas, curva hacia abajo



□ 2,3x4 mm

Uni-Townsend komplett, complete
complet, completo

27130-6
aufwärts gebogen, upwards curved
courbe vers le haut, curva hacia arriba



○ 3x5 mm

Uni-Oval komplett, complete
complet, completo

27130-7



□ 3x9 mm

Uni-Kevorkian komplett, complete
complet, completo

27130-8



○ 3x4 mm

Uni-Burke komplett, complete
complet, completo

27130-9



△ 3,8x6 mm

Schuhmacher komplett, complete
complet, completo

27130-10

Biopsiezangen
Biopsy Punches
Pinces emporte-pièces à biopsie
Pinzas para biopsia



SCHWERT
 SWORD · ESPADA
 EPEE · SPADA



Uni-Griff mit Ring
 Handle with ring
 Manche avec anneau
 Mango con anillo

27131



Uni-Griff
 Handle
 Manche
 Mango

27132

Aufsatz allein mit Rohr · Tip only with tube · Embout seulavec tubes ralloge · Punta soll con tubo de extensión



○ 3x7 mm

Uni-Tischler Aufsatz allein mit Rohr
 Tip only with tube

27133-1

gerade, straight
 droit, recta



○ 3x7 mm

Uni-Tischler Aufsatz allein mit Rohr
 Tip only with tube

27133-2

abwärts gebogen, downwards curved
 courbe vers le bas, curva hacia abajo



○ 3x7 mm

Uni-Tischler Aufsatz allein mit Rohr
 Tip only with tube

27133-3

aufwärts gebogen, upwards curved
 courbe vers le haut, curva hacia arriba



□ 2,3x4 mm

Uni-Townsend Aufsatz allein mit Rohr
 Tip only with tube

27133-4

gerade, straight
 droit, recta



□ 2,3x4 mm

Uni-Townsend Aufsatz allein mit Rohr
 Tip only with tube

27133-5

abwärts gebogen, downwards curved
 courbe vers le bas, curva hacia abajo



□ 2,3x4 mm

Uni-Townsend Aufsatz allein mit Rohr
 Tip only with tube

27133-6

aufwärts gebogen, upwards curved
 courbe vers le haut, curva hacia arriba



○ 3x5 mm

Uni-Oval Aufsatz allein mit Rohr
 Tip only with tube

27133-7



□ 3x9 mm

Uni-Kevorkian Aufsatz allein mit Rohr
 Tip only with tube

27133-8



○ 3x4 mm

Uni-Burke Aufsatz allein mit Rohr
 Tip only with tube

27133-9



△ 3,8x6 mm

Schuhmacher Aufsatz allein mit Rohr, Tip only with tube
 Embout seulavec tubes ralloge, Punta soll con tubo de extensión

27133-10



SCHWERT
SWORD - ESPADA
EPEE - SPADA

Biopsiezangen
Biopsy Punches
Pinces emporte-pièces à biopsie
Pinzas para biopsia

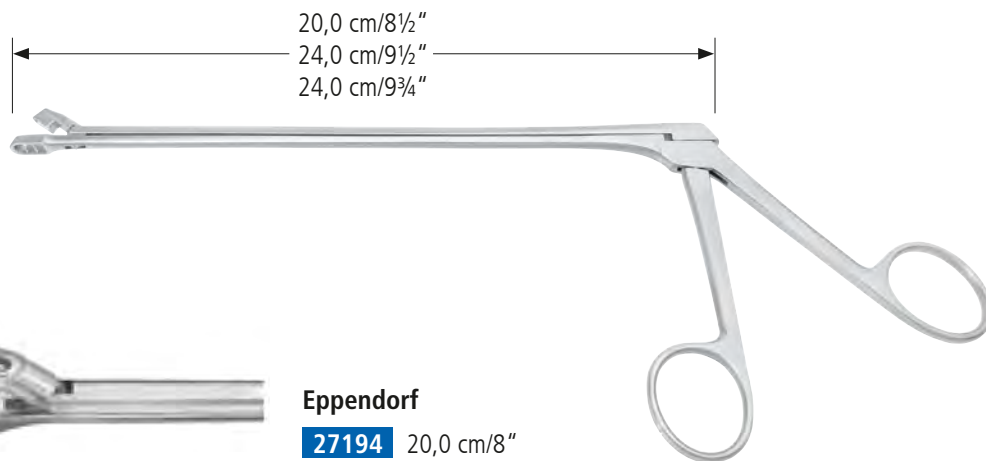

Eppendorf

27194 20,0 cm/8"
20,0 cm/8"

□ 4,5x8 mm



Wittner

27190-1 20,0 cm/8"
gebogen, curved
courbes, curvas

□ 4,5x8 mm

Wittner

27190-2 20,0 cm/8"
gerade, straight
droit, recta

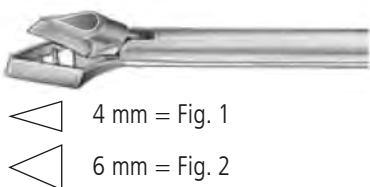

Schumacher

27182-1 24,0 cm/9 1/2"
Fig. 1

△ 4 mm = Fig. 1

△ 6 mm = Fig. 2

Schumacher

27182-2 24,0 cm/9 1/2"
Fig. 2

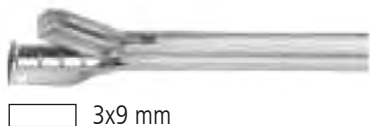

Kevorkian

27195 24,0 cm/9 3/4"

□ 3x9 mm

Biopsiezangen
Biopsy Punches
Pinces emporte-pièces à biopsie
Pinzas para biopsia



SCHWERT
SWORD · ESPADA
EPEE · SPADA



Schubert

27158-21 21,0 cm/8¼"
27158-29 29,0 cm/11½"

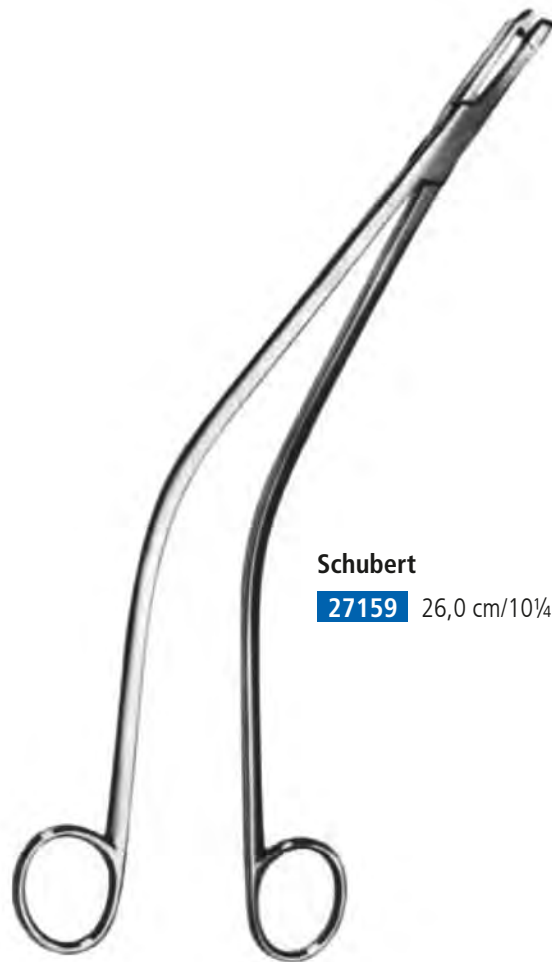

Schubert

27159 26,0 cm/10¼"



SCHWERT
SWORD · ESPADA
EPEE · SPADA

Biopsiezangen
Biopsy Punches
Pinces emporte-pièces à biopsie
Pinzas para biopsia



Tischler

27161

27,0 cm/10½"

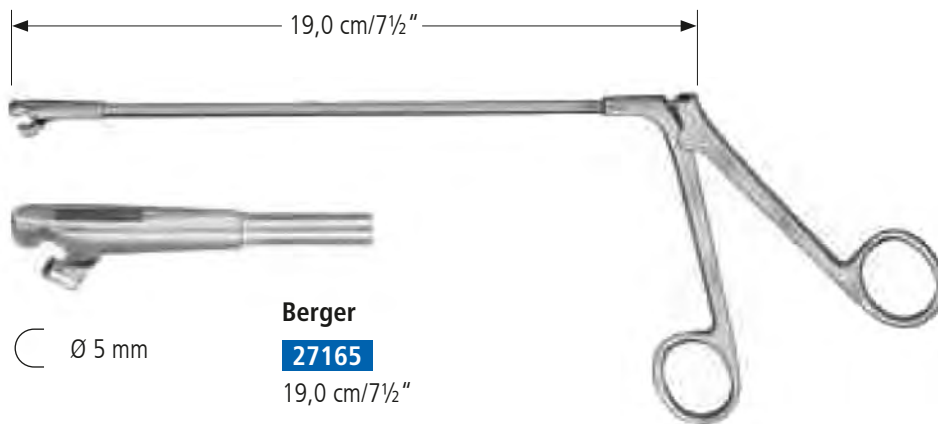

19,0 cm/7½"

∅ 5 mm

Berger

27165

19,0 cm/7½"

Biopsiezangen
Biopsy Punches
Pinces emporte-pièces à biopsie
Pinzas para biopsia



Alexander
27166
 28,0 cm / 11"



SCHWERT
 SWORD · ESPADA
 EPEE · SPADA

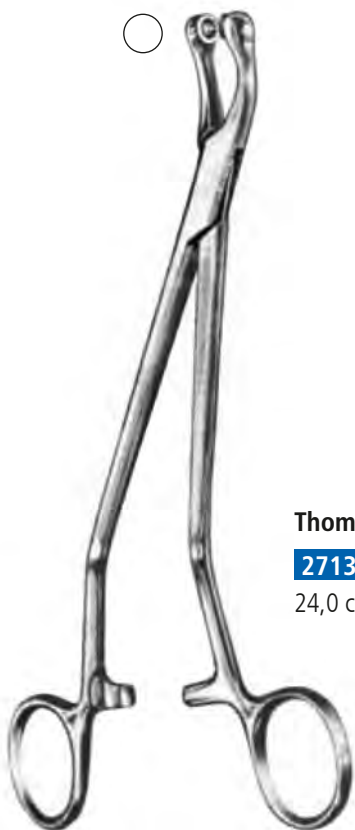

Thoms-Gaylor
27135-24
 24,0 cm / 9½"



27153-1

eckig
 angular
 angulaire
 angular

Van Doren
 24,0 cm / 9½"



27153

rund
 round
 ronde
 redonda



SCHWERT
SWORD · ESPADA
EPEE · SPADA

Biopsieküretten Biopsy Currettes Curettes pour biopsie Curetas para biopsia



Novak

23,0 cm/9" mm

Fig. 1	27116-1	1
Fig. 2	27116-2	2
Fig. 3	27116-3	3
Fig. 4	27116	4

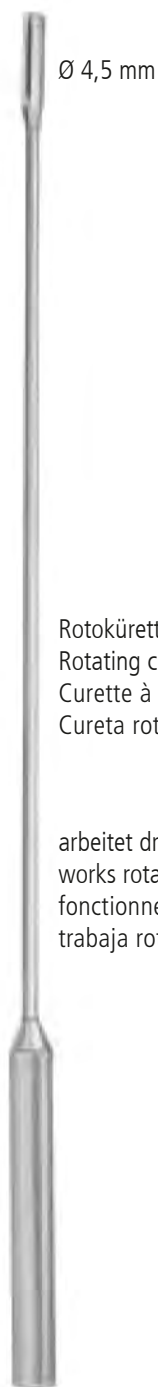

Ø 4,5 mm

Rotokürette
Rotating curette
Curette à rotation
Cureta rotatoria

arbeitet drehend
works rotating
fonctionne avec rotation
trabaja rotatoria

Rotokürette

27120
30,0 cm/11¾"



1 mm

schmal
narrow
étroite
estrecha

Kevorkian

27121
30,0 cm/11¾"

Biopsieküretten
Biopsy Currettes
Curettes pour biopsie
Curetas para biopsia



SCHWERT
SWORD · ESPADA
EPEE · SPADA



Kevorkian

27122-1 2,5 mm

ohne Korb, eckig
without basket, angular
sans panier, angulaire
sin cesta, angular

Kevorkian

27122-2 2,2 mm

mit Korb, rund
with basket, round
avec panier, ronde
con cesta, redonda

Kevorkian-Young

27122-3 2,5 mm

mit Korb, eckig
with basket, angular
avec panier, angulaire
con cesta, angular

Kevorkian
30,0 cm/11¾"



Novak-Schoeckaert

27123

24,0 cm/9½"

Luer-Lock



SCHWERT
SWORD · ESPADA
EPEE · SPADA

Uterusküretten
Uterine Curettes
Curettes utérines
Curetas uterinas



Fig. 1 7,5 mm **Fig. 2** 8,5 mm **Fig. 3** 10 mm **Fig. 4** 11,5 mm **Fig. 5** 13,5 mm **Fig. 6** 14,5 mm

Thomas stumpf, biegsam, glatt
28,0 cm/11" blunt, malleable, smooth
mousse, malléable, lisse
mm roma, maleable, lisa

Fig. 1	7,5	26924-1
Fig. 2	8,5	26924-2
Fig. 3	10	26924-3
Fig. 4	11,5	26924-4
Fig. 5	13,5	26924-5
Fig. 6	14,5	26924-6



Sims 25,0 cm/10" **Fig. 1** 7,5 mm **Fig. 2** 8,5 mm **Fig. 3** 10 mm **Fig. 4** 11,5 mm **Fig. 5** 13,5 mm **Fig. 6** 14,5 mm

		scharf, biegsam	scharf, fest	stumpf, biegsam	stumpf, fest
		sharp, malleable	sharp, rigid	blunt, malleable	blunt, rigid
		tranchante, malléable	tranchante, rigide	mousse, malléable	mousse, rigide
	mm	cortante, maleable	cortante, rigida	roma, maleable	roma, rigida

Fig. 1	7,5	26935-A1	26934-A1	26935-B1	26934-B1
Fig. 2	8,5	26935-A2	26934-A2	26935-B2	26934-B2
Fig. 3	10	26935-A3	26934-A3	26935-B3	26934-B3
Fig. 4	11,5	26935-A4	26934-A4	26935-B4	26934-B4
Fig. 5	13,5	26935-A5	26934-A5	26935-B5	26934-B5
Fig. 6	14,5	26935-A6	26934-A6	26935-B6	26934-B6

Uterusküretten
Uterine Curettes
Curettes utérines
Curetas uterinas



SCHWERT
 SWORD · ESPADA
 EPEE · SPADA



Recamier
 31,0 cm/12¼"

	mm	scharf, biegsam sharp, malleable tranchante, malléable cortante, maleable	scharf, fest sharp, rigid tranchante, rigide cortante, rigida	stumpf, biegsam blunt, malleable mousse, malléable roma, maleable	stumpf, fest blunt, rigid mousse, rigide roma, rigida
Fig. 00	5	26955-A00	26954-A00	26955-B00	26954-B00
Fig. 0	6	26955-A0	26954-A0	26955-B0	26954-B0
Fig. 1	7	26955-A1	26954-A1	26955-B1	26954-B1
Fig. 2	8	26955-A2	26954-A2	26955-B2	26954-B2
Fig. 3	8	26955-A3	26954-A3	26955-B3	26954-B3
Fig. 4	11	26955-A4	26954-A4	26955-B4	26954-B4
Fig. 5	12	26955-A5	26954-A5	26955-B5	26954-B5
Fig. 6	14	26955-A6	26954-A6	26955-B6	26954-B6
Fig. 7	15	26955-A7	26954-A7	26955-B7	26954-B7
Fig. 8	16	26955-A8	26954-A8	26955-B8	26954-B8
Fig. 9	19	26955-A9	26954-A9	26955-B9	26954-B9
Fig. 10	20	26955-A10	26954-A10	26955-B10	26954-B10
Fig. 11	21	26955-A11	26954-A11	26955-B11	26954-B11
Fig. 12	23	26955-A12	26954-A12	26955-B12	26954-B12
Fig. 13	25	26955-A13	26954-A13	26955-B13	26954-B13
Fig. 14	30	26955-A14	26954-A14	26955-B14	26954-B14
Fig. 15	35	26955-A15	26954-A15	26955-B15	26954-B15
Fig. 16	40	26955-A16	26954-A16	26955-B16	26954-B16



SCHWERT
SWORD · ESPADA
EPEE · SPADA

Uterusküretten
Uterine Curettes
Curettes utérines
Curetas uterinas



Fig. 0
16 mm

Fig. 1
18 mm

Fig. 2
19,5 mm

Fig. 3
21,5 mm

Fig. 4
13,5 mm

Fig. 5
26 mm

Fig. 6
28,5 mm



Bumm
28,0 cm/11"

		scharf, biegsam sharp, malleable tranchante, malléable mm cortante, maleable	stumpf, biegsam blunt, malleable mousse, malléable roma, maleable
Fig. 0	6	26961-A0	26961-B0
Fig. 1	7	26961-A1	26961-B1
Fig. 2	8	26961-A2	26961-B2
Fig. 3	9	26961-A3	26961-B3
Fig. 4	11	26961-A4	26961-B4
Fig. 5	12	26961-A5	26961-B5
Fig. 6	14	26961-A6	26961-B6

Uterusküretten
Uterine Curettes
Curettes utérines
Curetas uterinas



SCHWERT
SWORD · ESPADA
EPEE · SPADA



doppel, scharf-stumpf
double, sharp-blunt
double, tranchante-mousse
doble, cortante-roma

Blake

26970

27,0 cm/10½"



SCHWERT
SWORD · ESPADA
EPEE · SPADA

**Uteruslöffel
Uterine Curettes
Curettes utérines
Curetas uterinas**

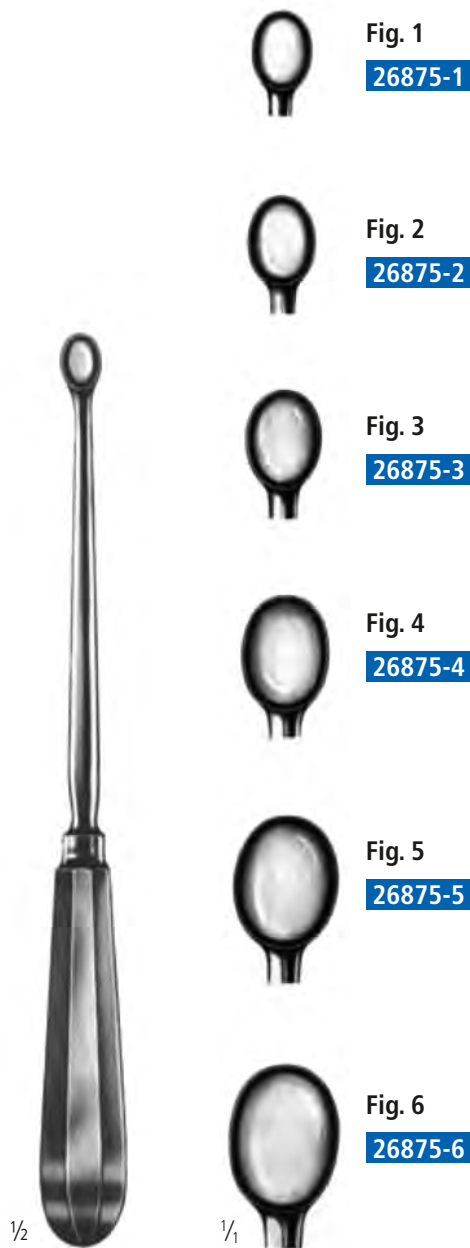

Simon
25,0 cm/10"
scharf, fest
sharp, rigid
tranchante, rigide
cortante, rigida

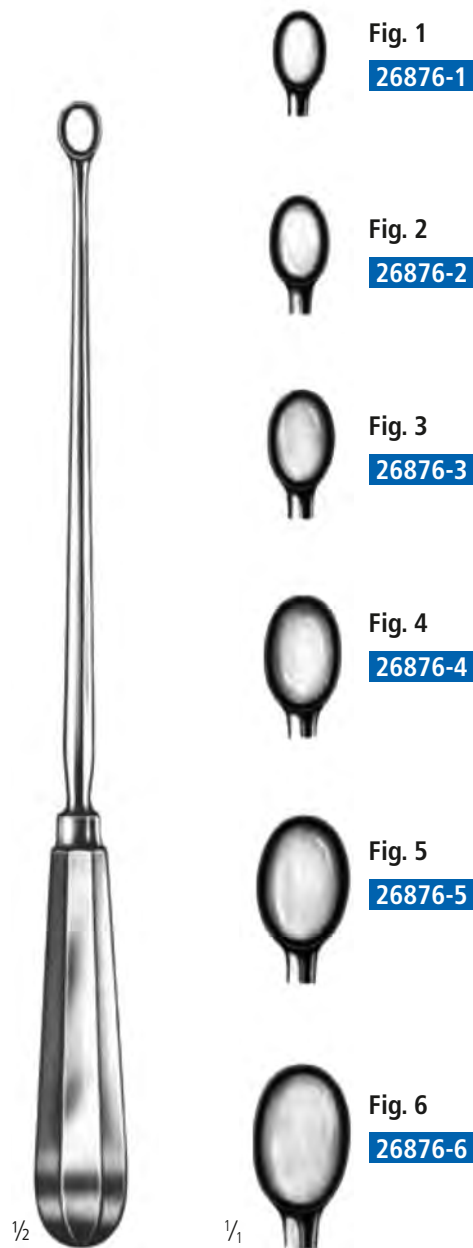

Schroeder
30,0 cm/12"
scharf, fest
sharp, rigid
tranchante, rigide
cortante, rigida

Beckenzirkel
Pelvimeters
Pelvimètres
Pelvimetros

Geburtszangen
Obstetrical Forceps
Forceps obstétriques
Forceps obstétricos



SCHWERT
 SWORD · ESPADA
 EPEE · SPADA



Nur zur Vergleichsmessung
 Only for comparison measurement
 Pour une mesure comparative uniquement
 Sólo a efectos comparativos

Collin

27520

35,0 cm/13¾"



Martin

27524

34,0 cm/13½"



Naegele

27610-36 36,0 cm/14"

27610-39 40,0 cm/16"



Simpson-Braun

27626-30 30,0 cm/12"

27626-33 33,0 cm/13"

27626-36 36,0 cm/14"



Simpson-Luikart

27635 36,0 cm/14"





SCHWERT
SWORD - ESPADA
EPEE - SPADA

Geburtszangen
Obstetrical Forceps
Forceps obstétriques
Forceps obstétricos



Piper

27641 44,0 cm/17¼"



Elliot

27642 38,0 cm/15"



Mc Lean-Tucker

27643 39,0 cm/15½"



Kielland

27644 41,0 cm/16"

Plazenta- und Abortuszangen
 Placenta and Ovum Forceps
 Pincés placentaires
 Pinzas para aborto y placenta



SCHWERT
 SWORD · ESPADA
 EPEE · SPADA

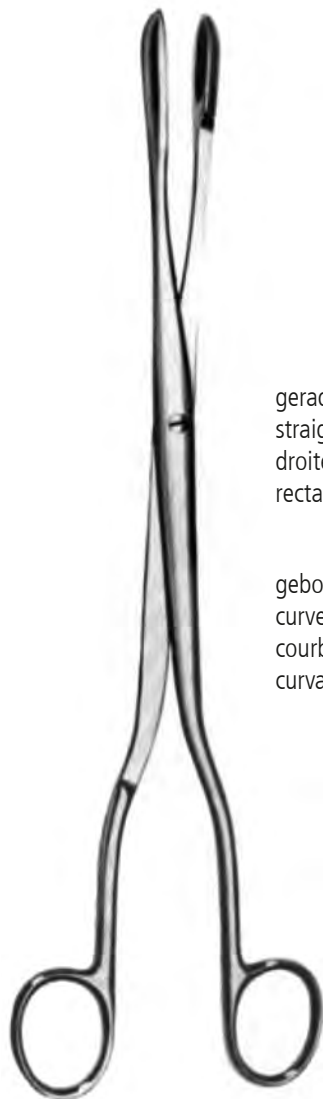

Winter
 28,0 cm/11"

gerade
 straight
 droite
 recta

gebogen
 curved
 courbe
 curva



27888-1



27888-2



27888-3

27889-1

27889-2

27889-3

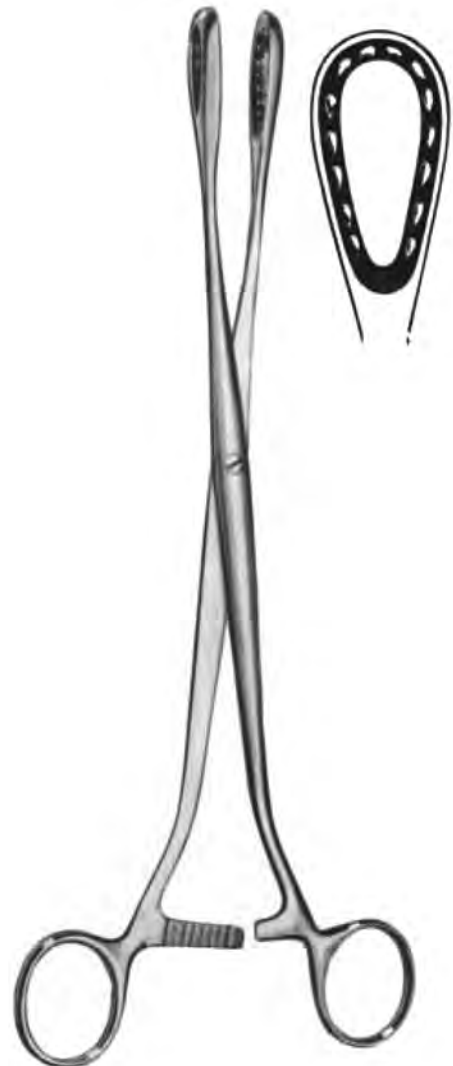

27880
 gerade
 straight
 droite
 recta

Saenger
 27,0 cm/7½"

27881
 gebogen
 curved
 courbe
 curva



Uterusklemmzange
Uterine Hemostasis Forceps
Pince-clamp utérine
Pinza-clamp uterina

SCHWERT
SWORD - ESPADA
EPEE - SPADA



Green-Armytage

26468

21,0 cm/8¼"



SCHWERT
SWORD · ESPADA
EPEE · SPADA

Verschiedene Nagelinstrumente Miscellaneous Nail Instruments Instruments divers pour les ongles Instrumentes diverses para las uñas





Haut- und Nagelinstrumente
Cuticle and Nail Instruments
Instruments à ongles et à envies
Instrumentos para uñas y cuticulares

SCHWERT
SWORD · ESPADA
EPEE · SPADA



29475 10,0 cm/4"
Hautzange
Cuticle Nippers
Pince à envies
Pinza para cuticulares



29476 10,5 cm/4¼"
Hautzange
Cuticle Nippers
Pince à envies
Pinza para cuticulares



29490 14,5 cm/5¾"
Pedicure-Zange
Nail Nippers
Pincés à ongles
Alicates corta-uñas



29491 14,5 cm/5¾"
Kopfschneider
Nail Nippers
Pincés à ongles
Alicates corta-uñas



29492 14,5 cm/5¾"
Nagelzange
Nail Nippers
Pincés à ongles
Alicates corta-uñas

Nagelinstrumente
Nail Instruments
Instrumentos à ongles
Instrumentos para uñas



SCHWERT
 SWORD · ESPADA
 EPEE · SPADA



29493 12,0 cm/4¾"

Nagelzange
 Nail Nippers
 Pincès à ongles
 Alicates corta-uñas



29495 12,0 cm/4¾"

29497 13,5 cm/5¼"

Nagelzange
 Nail Nippers
 Pincès à ongles
 Alicates corta-uñas



29498 13,0 cm/5"

Nagelzange
 Nail Nippers
 Pincès à ongles
 Alicates corta-uñas



Nagelschere
 Nail Scissors
 Ciseaux à ongles
 Tijeras para uñas

29487-9 9,0 cm/3½"

29487-10 10,5 cm/4½"

gebogen
 curved
 courbes
 curvas



Nagelschere
 Nail Scissors
 Ciseaux à ongles
 Tijeras para uñas

29488-9 9,0 cm/3½"

gebogen
 curved
 courbes
 curvas



SCHWERT
SWORD · ESPADA
EPEE · SPADA

Nagelinstrumente
Nail Instruments
Instruments à ongles
Instrumentos para uñas

Fingerringsägen
Finger Ring Saws
Scies pour bagues
Sierras para abrir anillos



15864 17,0 cm/6¾"

Fingerring-Säge
Finger Ring Saw
Scie pour bagues
Sierra para abrir anillos

15864-1

Sägeblatt
Saw blade
Lame de scie
Hoja de sierra



15865 16,0 cm/6¼"

Fingerring-Säge
Finger Ring Saw
Scie pour bagues
Sierra para abrir anillos

15865-1

Sägeblatt
Saw blade
Lame de scie
Hoja de sierra



15880 14,0 cm/5½"

Nagelausreibzange
Forceps for tearing out toe and finger nails
Pincés pour l'extraction des ongles
Pinzas para arrancar uñas



SCHWERT
SWORD · ESPADA
EPEE · SPADA

Stichwortverzeichnis

A	
Abortuszangen	477
Adenotome	365
Adlerkreutz , Chirurgische Pinzetten	30
Adson , Anatomische Pinzetten	26
Anatomische Pinzetten mit HM-Einsätzen	97
Arterienklemmen	129
Bohrer-, Führungs- und Dura-Schutzzangen	150
Chirurgische Pinzetten	30
Chirurgische Pinzetten mit HM-Einsätzen	97
Gefäßhaken	293
Hauthaken	293
Hohlmeisselzangen	203
Nadelhalter	77
Raspatorien	175
Wundspreizer	245, 246
Adson-Baby , Wundspreizer	244
Adson Brown , Chirurgische Pinzetten	31
Adson-Tönnis , Präparierscheren	55
Akku-Gipssägen	68, 69
Alan Parks , Analspreizer	431
Alexander , Biopsiezangen	467
Flachmeissel	156
Hohlmeissel	156
Raspatorien	172
Allis , Darm- und Gewebefasszangen	406, 407
Gewebefasszangen mit HM-Einsätzen	108
Allis-Adair , Darm- und Gewebefasszangen	406
Allis-Baby , Darm- und Gewebefasszangen	406
Allison , Lungenspatel	274
Alm , Sperrelevatoren	320
Amputations -Retraktoren, -sägen	148, 149
Analspreizer	430, 431
Anastomosenklemmen	409
Anatomie-Scheren	58
Anatomische Pinzetten	25 – 28
Anatomische Pinzetten, fein	36
Anatomische Pinzetten mit HM-Einsätzen	96, 97
Anderson-Adson , Wundsperrerr	249
Andrew , Zungenspatel	371
Anlege- und Abnehmezange für Kopfhautklammern	381
Anuskope	427
Arruga , Augennadelhalter	79
Augennadelhalter mit HM-Einsätzen	100
Kapselpinzetten	308
Arterienklemmen	122 – 132, 134 – 136
Arthur , Splitterzangen	22
Asch , Septumzangen	343
Atrauma-Pinzetten	35
Atraumatische Bulldogklemmen	122
Aufricht , Nasenflügelhaken	360
Nasenraspeln	359
Augen -häkchen	315
-messer	314
-nadelhalter	78 – 79
-nadelhalter mit HM-Einsätzen	100
-scheren	49
Augen -sonden	313
Auvard , Scheidenspekula	447
Ayer , Chalazionspinzetten	311
B	
Babcock , Darmfasszangen	407
Gewebefasszangen mit HM-Einsätzen	108
Babinsky , Perkussionshämmer	11
Baby-Adson , Arterienklemmen	129
Baby-Collin , Bauchdeckenhalter	251
Baby-Crile , Arterienklemmen	128
Baby-Kern , Knochenhaltezangen	193
Baby-Lexer , Präparierscheren	45
Baby-Olsen-Hegar , Nadelhalter	75
Nadelhalter mit HM-Einsätzen	107
Baby-Roux , Wundhaken	240
Baby-Satinsky , Gefäßklemmen	277
Baby-Senn-Miller , Wundhaken	238
Baby-Tischler , Biopsiezangen	460
Backhaus , Tuchklemmen	139
Baggish , Biopsiezangen	461
Bailey , Rippenkonraktoren	274
Bailey-Baby , Rippenkonraktoren	274
Bailey-Gibbon , Rippenkonraktoren	274
Bainbridge , Arterienklemmen	126
Bakes , Gallengangdilatoren	417
Balfour , Bauchdeckenhalter	253, 254
Balfour-Baby , Bauchdeckenhalter	253
Ballenger , Schwingmesser	362
Ballenger-Hajek , Septum-Elevatoren	353
Bane (Hartmann) , Hohlmeisselzangen	202
Bandscheiben-Rongeure	294, 296 – 299
Bandscheibenstanzen	300, 301
Barnhill , Ringmesser	364
Barr , Mastdarm-Spekula	429
Barraquer , Augennadelhalter	79
Augennadelhalter mit HM-Einsätzen	100
Cilienpinzetten	312
Fixierpinzetten	309
Barth , Ohrküretten	378
Bauchdeckenhalter	250 – 258
Bauchdecken-Scheren	45
Bauchspatel	259, 260
Baumgartner , Nadelhalter mit HM-Einsätzen	103
Beaupré , Cilienpinzetten	312
Beckenzirkel	475
Beckmann , Ringmesser	364
Wundspreizer	245
Beckmann-Adson , Wundsperrerr	249
Beckmann-Eaton , Wundsperrerr	249
Beer , Cilienpinzetten	40
Bellucci , Ohrzängchen	382
Bengolea , Arterienklemmen	132
Bennett , Knochenhebel	184
Benson , Pylorusspreizer	408
Berger , Biopsiezangen	466
Bergmann , Hämmer	188



SCHWERT
SWORD · ESPADA
EPEE · SPADA

Stichwortverzeichnis

Bergmann , Verbandscheren	64
Berliner , Perkussionshämmer	11
Bernhard , Tuchklemmen	140
Beschneidungsinstrumente	422
Bethune , Rippenscheren	263
Beyer , Hohlmeisselzangen	198, 202
Billeau , Ohrschlingen	378
Biopsieküretten	468 - 469
Biopsiezangen	460 - 467
Bircher , Meniskotome	180
Bircher-Ganske , Knorpelfasszangen	191
Bishop-Harmon , Irispinzetten	307
Blake , Gallensteinzangen	416
Uterusküretten	473
Blasenspatel	420
Blasenwundspreizer	421
Blohmke , Tonsillenzangen	373
Blount , Knochenhebel	185
Meniskushaken	185
Blumenthal , Hohlmeisselzangen	201
Böhler , Hohlmeisselzangen	203
Knochensplitterzangen	207
Böttcher , Tonsillenscheren	56
Bohrer-, Führungs- und Dura-Schutzzangen	150
Bolzenschneider	154
Bonaccolto , Strabismuspinzetten	310
Bonney , Chirurgische Pinzetten	33
Bose , Tracheal-Häkchen	397
Bowman , Augensonden	313
Sperrelevatoren	320
Bozemann , Nadelhalter mit HM-Einsätzen	107
Tupferzangen	144
Boys-Allis , Darm- und Gewebefasszangen	406
Brand , Sehnenfasszangen	177
Braun , Hakenzangen	454
Uterus-Depressoren	453
Braun-Stadler , Dammscheren	51
Breisky , Scheidenspekula	444
Bronchialscheren	55
Brophy , Anatomische Pinzetten	28
Chirurgische Pinzetten	32
Brown , Nadelhalter	73
Bruenings , Tonsillenschnürer	374
Zungenspatel	371
Brunner , Führungshohlsonden	90
Rippenscheren	263
Brunner , Wundhaken	234, 235
Bruns , Scharfe Löffel	164, 165
Verbandscheren	64
Buchwald , Zungenspatel	371
Buck , Fremdkörperhebel	384
Ohrküretten	377
Perkussionshämmer	12
Buie , Rektal-Absaugrohre	436
Bulldogklemmen	122
Bumm , Uterusküretten	472
Bunge , Exenterationslöffel	318
Bunnell , Sehnenführer	177

Bunnell , Sehnen Schäler	177
Bunt , Sterilisierklammern	141
Burford , Rippensperrerr	266
Burke , Biopsiezangen	461
Busch , Nabelschnurscheren	52

C

Caplan , Septumscheren	342
Caroll , Sehnenfasszangen	177
Carpenter , Tonsillenenukleatoren	375
Tonsillennmesser	375
Caspar , Laminektomie-Zangen	295
Castañeda , Rippensperrerr	268
Castroviejo , Augennadelhalter	78
Augennadelhalter mit HM-Einsätzen	100
Hornhautscheren	323, 325
Markierungszirkel	321
Nahtpinzetten	309 - 311
Sperrelevatoren	320
Chalazionslöffel	318
Chalazionspinzetten	311
Charrière , Amputations- und Resektionssägen	148
Chelsea Eaton , Proktoskope	428
Cheron , Tupferzangen	145
Chirurgische Pinzetten	29 - 33
Chirurgische Pinzetten, fein	36
Chirurgische Pinzetten mit HM-Einsätzen	97
Chirurgische Scheren	42, 43, 47, 50
Chirurgische Scheren, fein	50, 52
Choanenhaken	360
Cilienpinzetten	40, 312
Cinelli , Nasen-Osteotome	356
Cleveland , Hohlmeisselzangen	200
Knochensplitterzangen	207
Cloward , Bandscheiben-Rongeurs	294
Laminektomiespreizer	304
Wirbelkörperspreizer	281
Colclough (Richter) , Bandscheibenstanzen	300, 301
Collier , Nadelhalter	73
Collin , Bauchdeckenhalter	251
Beckenzirkel	475
Hämmer	186
Collin , Scheidenspekula	442
Tupferzangen	145
Wundhaken	239
Wundklammer-Zangen	82
Zungenzangen	372
Collin-Loktite , Bauchdeckenhalter	250, 251
Cone , Wundspreizer	244
Converse , Nasenflügelhaken	360
Cooley , Rippensperrerr	267, 271
Cooper , Unterbindungsnadeln	89
Coppelson , Biopsiezangen	460
Coryllos , Wundhaken	232
Cottle , Choanenhaken	360
Hämmer	187
Nasenflügelhaken	360 - 362





SCHWERT
SWORD · ESPADA
EPEE · SPADA

Stichwortverzeichnis

Cottle , Nasen-Osteotome	355	De Martel-Wolfson , Klemmenhalter	410
Nasenplastik-Messer	363	Klemmenschließzangen	410
Nasenraspeln	359	Denhart , Mundsperrer	366
Nasenspekula	345	Denis-Browne , Bauchdeckenhalter	256
Nasen- und Ohrpinzetten	349	Derf , Nadelhalter	73
Septum- und Periost-Elevatorien	354	Nadelhalter mit HM-Einsätzen	101
Cottle-Neivert , Nasenflügelhaken	361	Dermatome	402
Crafoord , Arterienklemmen	131	Deschamps , Unterbindungsnadeln	83 – 87
Lungenlappenscheren	53	Desjardins , Gallenkanalklemmen	136
Crile , Arterienklemmen	127	Gallensteinlöffel	419
Nadelhalter	77	Gallensteinsonden	417
Gewebehaken	292	Gallensteinzangen	416
Wundhaken	214	Desmarres , Chalazionspinzetten	311
Crile-Rankin , Arterienklemmen	127	Lidhalter	321
Crile-Wood , Nadelhalter	73, 75	De Vilbiss , Schädelzangen	279
Nadelhalter mit HM-Einsätzen	103	Dieffenbach , Bulldogklemmen	122
Crutchfield , Schädelhalter	280	Dingmann , Knorpelfasszangen	190
Cusco , Scheidenspekula	441	Diszisionsmesser	314
Cushing , Anatomische Pinzetten	28	Dix , Nadeln und Flachmeißel	315
Bandscheiben-Rongeure	297	Nadeln und Hohlmeißel	315
Chirurgische Pinzetten	32	Douglas , Cilienpinzetten	40
Dekompressionshaken	215	Doyen , Bauchdecken-Scheren	45
Gefäßhaken	293	Darmklemmen	408, 411
Gewebehaken	292	Hämmer	186
Hauthaken	293	Myomheber	458
Pinzetten mit HM-Einsätzen	97	Ovarien-Fasszangen	457
Wundhaken	213	Raspatorien	172
Czerny , Hakenzangen	455	Scheidenspekula	444, 445
Mastdarm-Spekula	432	Sonden	17
		Tuchklemmen	139
		Wundhaken	226
		Zungenspatel	371
		Doyen-Stille , Wundhaken	224
D		Draht -kneifzangen mit HM-Einlagen	112 – 114
Dahlgren , Schädelzangen	279	-sägen	279
Dammscheren	51	-scheren	57
Dandy , Gewebehaken	292	-schneidezangen mit extraharten Einsätzen	114
Präparierscheren	55	-spannzangen mit HM-Einlagen	113
Dandy Crile , Arterienklemmen	128	-zangen	153, 154
Darm -fasszangen	406, 407	-ziehzangen	113
-klemmen	408, 409, 411 - 413	Dubois , Kephilotomie-Scheren	51
-quetschklemmen	410	Duplay , Hakenzangen	454
-scheren	58	Korn- (Polypen-) zangen	144
-spatel	259 - 260	Dissektoren	287 - 289
Dartigues , Uterus-Fasszangen	458	Duval , Gewebefasszangen mit HM-Einsätzen	108
Dastoor , Kapselsauger	308	Lungenfasszangen	275
Daubenspeck , Scharfe Löffel	167		
Davidson , Wundhaken	233	E	
Davis , Dissektoren	289	Echlin , Hohlmeißelzangen	204
Sterilisierpinzetten	146	Eder , Watte- und Tupferträger	437
Davis-Boyle , Mundsperrer	367, 369	Einführungsinstrumente für Drahtsägen	279
Dean , Tonsillenscheren	56	Elevatorien	176
Deaver , Chirurgische Scheren	43	Elliot , Geburtszangen	476
Wundhaken	229, 230	Elschnig , Fixierpinzetten	306
De Bakey , Atrauma-Pinzetten	35	Endospekula	448, 449
Nadelhalter mit HM-Einsätzen	103	Engel , Gipssägen	66
Wundspreizer	248	Engl. Mod. , Anatomische Pinzetten	26
Déjerine , Perkussionshämmer	12		
Dekompressionshaken	215		
De Martel-Wolfson , Anastomosenklemmen	409		





SCHWERT
SWORD · ESPADA
EPEE · SPADA

Stichwortverzeichnis

Entropiumpinzetten	312
Eppendorf , Biopsiezangen	464
Esmarch , Gipsmesser	65
Verbandscheren	63
Eves , Tonsillenschnürer	374
Exenterationslöffel	318

F

Faden -führer	283
-pinzetten	308
Farabeuf , Knochenhaltezzangen	192
Raspatorien	170
Wundhaken	239
Farabeuf-Lambotte , Knochenhaltezzangen	192
Farrell (Lathbury) , Watteträger	19
Fasszangen	459
Faulkner , Küretten	353
Faure , Peritoneumklemmen	138
Feilchenfeld , Splitterpinzetten	38
Fergusson , Knochenhaltezzangen	192
Ferris-Smith-Kerrison , Bandscheiben-Rongeure	299
Fingerring-Sägen	482
Finocchietto , Nadelhalter	76
Nadelhalter mit HM-Einsätzen	103
Rippensperrerr	265, 269
Finocchietto-Baby , Rippensperrerr	269
Finocchietto-Baby-Haight , Rippensperrerr	265
Finocchietto-Burford , Rippensperrerr	270
Finocchietto-Infant , Rippensperrerr	265
Finsen , Wundspreizer	241
Fisch , Mikro-Häkchen	284
Fischer , Irispinzetten	306
Fistelsonden	18
Fixierpinzetten	306, 309
Flachmeißel	158, 162, 356, 357
Flachzangen	152, 153
Flexible IUD Fasszangen	459
Foerster , Schwammzangen	145
Fomon , Nasenflügelhaken	361
Nasen-Osteotome	356
Nasenplastik-Messer	363
Nasenraspeln	359
Nasenscheren	56
Foregger , Laryngoskope	389, 394
Laryngoskope, Kaltlicht	394
Fox , Lupusküretten	403
Frakturschienen	372
Frankenfeld , Rektal-Schnürer	437
Franz , Bauchdeckenhalter	255
Frazier , Bauchdeckenhalter	258
Dissektoren	289
Gefäßhaken	293
Hauthaken	293
Freer , Flachmeißel	357
Nasenflügelhaken	361
Septum-Elevatorien	353
Septum-Hohlmeißel	357

Fremdkörper	
-hebel	384
-Hohlmeißel	315
-instrumente	316
-nadeln	315
-zangen	422
French , Nadelhalter mit HM-Einsätzen	101
French-Mathieu , Nadelhalter mit HM-Einsätzen	105
Fritsch , Wundhaken	225
Führungshohlsonden	90 – 92

G

Galeahaken	286
Gallaher , Knochenfeilen	178
Gallen -gangdilatoren	417
-kanalklemmen	135, 136
-steinlöffel	418, 419
-steinsonden	417
-steinzangen	416
Geburtszangen	475, 476
Gefäß -dilatoren	277
-häkchen	283
-haken	293
-klemmen	276, 277
-scheren	53 – 55
Gelpi-Loktite , Wundspreizer	248
Gemini , Präparier- und Ligaturklemmen	133
Gerald , Anatomische Pinzetten	27
Anatomische Pinzetten mit HM-Einlagen	97
Chirurgische Pinzetten	31
Chirurgische Pinzetten mit HM-Einlagen	97
Gewebe -haken	291, 292
-fasszangen	406, 407
-fasszangen mit HM-Einsätzen	108
-scheren	55
-spatel	282
Giertz-Stille , Rippenscheren	263
Gigli , Drahtsägen	299
Sägegriffe	299
Gill , Irispinzetten	306
Gill-Arruga , Kapselpinzetten	308
Gill-Hess , Irispinzetten	306
Gillies , Chirurgische Pinzetten	31
Häkchen	403
Nadelhalter	74
Nadelhalter mit HM-Einsätzen	107
Gillies-Baby , Nadelhalter mit HM-Einsätzen	107
Gips -abreißzangen	66
-messer	65
-sägen	66 – 71
-scheren	65
-spreizer	66
Glover , Atraumatische Bulldogklemmen	122
Gluck , Rippenscheren	262
Goldmann-Fox , Chirurgische Scheren	43
Goldstein , Sperrelevatorien	319
Good , Tonsillenscheren	56



SCHWERT
SWORD · ESPADA
EPEE · SPADA

Stichwortverzeichnis

Gosset , Bauchdeckenhalter	252
Gradle , Cilienpinzetten	312
Graefe , Augenhäkchen	316
Fixierpinzetten	309
Irispinzetten	306
Irisscheren	49
Nadeln und Hohlmeißel	316
Schielhaken	317
Starmesser	314
Graham , Gefäßhaken	293
Hauthaken	293
Graig , Nasen-Septumzangen	350
Grave , Scheidenspekula	441
Grazil , Chirurgische Scheren	42
Green , Fixierpinzetten	309
Schlauchklemmen	141
Green-Armytage , Uterusklemmzangen	478
Gross , Korn- (Polypen-) zangen	143
Grünwald-Jansen , Nasen- und Ohrpinzetten	349
Guthrie , Augenhäkchen	316
Guyon , Katheter-Einführungsinstrumente	419
Gynäkologische Scheren	47, 50

H

Haberer , Bauch- und Darmspatel	259
Haglund-Stille , Gipsspreizer	66
Haight , Rippensperrer	270
Hajek , Keilbeinstanzen	352
Hämmer	187
Hakenzangen	454 – 456
Häkchen	403
Häkchen, fein	284
Halle , Duramesser	293
Scharfe Löffel	168
Halsey , Nadelhalter	73
Nadelhalter mit HM-Einsätzen	104
Halsted-Mosquito , Arterienklemmen	125
Hämmer	186 – 189
Hämorrhoidal-Fasszangen	426
Hank , Uterusdilatoren	452
Harken , Gefäßklemmen	277
Rippensperrer	273
Harrington , Wundhaken	230
Hartmann , Arterienklemmen	122
Nasenspekula	344
Ohrspekula	12
Ohrzängchen	381 - 383
Polypenzangen	348
Stimmgabeln	13
Hartmann-Halle , Nasenspekula	344
Hartmann-Noyes , Ohrzängchen	381
Hartmann-Weingärtner , Ohrzängchen	381
Haut -haken	293
-instrumente	480
-stanzen	401
-zangen	480
Heaney , Hysterektomieklappen	137

Heaney , Nadelhalter	76
Nadelhalter mit HM-Einsätzen	104
Heaney-Ballentine , Hysterektomieklappen	137
Heath , Drahtscheren	57
Hegar , Nadelhalter mit HM-Einsätzen	102
Uterusdilatoren	450 – 452
Hegar-Baumgartner , Nadelhalter	74
Hegenbarth , Wundklammer-Pinzetten	82
Heifetz , Hirnspatel	282
Heifetz , Tumorphinzetten	39
Heiss , Arterienklemmen	130
Heister , Mundsperrer	366
Helferich-Bier , Amputations- und Resektionssägen	149
Henke , Tonsillendissektoren	375
Tonsillenseparatoren	375
Henning , Gipsspreizer	66
Hess , Irispinzetten	307
Heymann , Nasenscheren	56
Heymann-Knight , Polypenzangen	348
Hibbs , Flachmeißel	162
Hohlmeißel	163
Osteotome	162, 163
Hirschmann , Anuskope	427
Hoer , Separatoren	289
Hösel , Wundhaken	227
Hohmann , Knochenheber	182, 183
Hohlmeißel	155 – 161, 163, 357
Hohlmeißelzangen	198 – 205
Hoke , Osteotome	162
Holsher , Gewebehaken	291
Holtzheimer , Wundspreizer	241
Holzbach , Bauchdeckenhalter	250
Hopkins , Gipsmesser	65
Hornhautscheren	323, 325
Horsley , Separatoren	290
Howarth , Rasporien	171
Hüftgelenkhaken	220
Hunter , Splitterpinzetten	38
Hurd , Tonsillendissektoren	375
Tonsillenretraktoren	375
Hylin , Rasporien	173
Hysterektomieklappen	137

I

Inge , Wirbelkörperspreizer	281
Inge-Lamina , Wirbelkörperspreizer	281
Instrumente zur Schädelöffnung	279
Inzisionsscheren	43
Iridektomiescheren	324
Iris -messer	314
-pinzetten	306, 307
-scheren	48, 49
-scheren „Ribbon type“	328
Irisschere, Scheren mit HM-Schneiden	111
Supercut-Scheren	61
Israel , Wundhaken	219
Itrson , Tracheal-Häkchen	397





SCHWERT
SWORD · ESPADA
EPEE · SPADA

Stichwortverzeichnis

Ives-Fansler, Anuskoipe 427

J

Jackson, Tracheal-Häkchen 398
Jaeger, Augenhäkchen 316
Jakobs, Hakenzangen 456
Jansen, Hohlmeisselzangen 201
Jansen, Nasen- und Ohrpinzetten 349
Ohrküretten 378
Raspatorien 173
Wundspreizer 241
Jennings, Mundsperrer 366
Jobson-Horne, Watteträger 19
John Hopkins, Bulldogklemmen 122
Jones, Tuchklemmen 139
Joseph, Feine Chirurgische Scheren 52
Knochenfeilen 178
Nasenflügelhaken 360, 361
Nasenplastik-Messer 363
Nasensägen 358
Raspatorien 176
Septum- und Periost-Elevatorien 354
Joseph-Masing, Septum-Elevatorien 353
Judd-Allis, Darm- und Gewebefasszangen 406
Judd-Masson, Blasenwundspreizer 421

K

Kader, Bauch- und Darmspatel 260
Kallmorgen, Scheidenspekula 443
Kalt, Augennadelhalter 79
Augennadelhalter mit HM-Einsätzen 100
Kantrowitz, Arterienklemmen 135
Kapsel -fasszangen 424
-pinzetten 308
-sauger 308
Kathetereinführungsinstrumente 419
Katzin, Hornhautscheren 323
Kehlkopfspiegel 10
Keilbeinstanzen 352
Kelly, Arterienklemmen 127
Sphinkteroskope 429
Proktoskope 428
Feine chirurgische Scheren 50
Uterus-Polypenzangen 457
Wundhaken 222, 238
Kelly-Rankin, Arterienklemmen 127
Kephalotomie-Scheren 51
Kern, Knochenhalte-zangen 194
Kerrison, Kieferhöhlenstanzen 352
Kevorkian, Biopsieküretten 468, 469
Biopsiezangen 460, 464
Kevorkian-Young, Biopsieküretten 469
Key, Raspatorien 172
Keyes, Hautstanzen 401
Keyes Set, Hautstanzen 401
Kieferhöhlenstanzen 352

Kielland, Geburtszangen 476
Killian, Nasenspekula 346
Nasenzangen 350
Periost- und Septum-Elevatorien 353, 354
Septum-Hohlmeißel 357
Septumscheren 342
Killian-Claus, Septum-Hohlmeißel 357
Kilner, Häkchen 403
Nadelhalter mit HM-Einsätzen 107
Nasenflügelhaken 360
Präparierscheren 52
Kilner-Doughty (Russel-Davis), Mundsperrer 370
Kirschner, Bauchdeckenhalter 256
Klapp, Sehenscheidenhaken 214
Kleinert-Kutz, Hohlmeisselzangen 198
Klemmen
Anastomosen- 409
Arterien- 122 – 132, 134 – 136
Bulldog- 122
Darm- 409, 411 – 413
Darmquetsch- 410
Gallenkanal- 135, 136
Gefäß- 276, 277
Hysterektomie- 137
Ligatur- 130, 133
Magenquetsch- 410
Nierenstiel- 136
Penis- 422
Peritoneum- 138
Präparier- 130, 131, 133
Schlauch- 141, 142
Sinus- 143
Tuch- 139 – 141
Klemmenhalter 410
Klemmenschießzangen 410
Klemmzangen 137, 138
Knapp, Diszisionsmesser 314
Knapp-Clark, Sperrelevatorien 319
Knight, Septumzangen 350
Knochen-feilen 178, 179
-halteklammern 209
-halte-zangen 190 – 197
-hebel 181 – 185
-raspeln 179
-scheren 262, 264
-splitterzangen 206 – 208
Knorpelfasszangen 190, 191
Knorpelscheren 54
Knowles, Verbandscheren 63
Knüpfpinzetten 39, 312
Kocher, Arterienklemmen 125
Blasenspatel 420
Darmklemmen 409, 413
Führungshohlsonden 92
Wundhaken 217, 220, 223, 226
Kocher-Langenbeck, Wundhaken 220
Kocher-Wagner, Wundhaken 237
König, Führungshohlsonden 91



SCHWERT
SWORD · ESPADA
EPEE · SPADA

Stichwortverzeichnis

Koerte , Wundhaken	218
Kogan , Endoskopula	448, 449
Komedoneninstrumente	404
Kopfschneider	480
Korn- (Polypen-) zangen	143, 144
Krampfaderbestecke	20
Krause , Polypenschnürer	347
Krayenbühl , Gefäßhäkchen	283
Kristeller , Scheidenspekula	439, 440
Kronecker , Unterbindungsnadeln	88
Kropffasszangen	399
Kuemmel , Bauch- und Darmspatel	260
Küretten	353, 377 – 379, 468
Kuhnt , Starmesser	314

L

Laborde , Tracheal-Dilatatoren	397
La Force , Adenotome	365
Lahey , Gallenkanalklemmen	135
Kropffasszangen	399
Wundhaken	222
Lambert , Chalazionspinzetten	311
Lambotte , Knochenhalte zangen	195
Osteotome	157
Raspatorien	171
Laminektomiespreizer	302 – 304
Laminektomie-Zangen	295, 296
Lancaster , Sperreivatoren	320
20Lane , Chirurgische Pinzetten	33
Knochenhalte zangen	194
Knochenhebel	184
Schraubendreher	151
Tuchklemmen	140
Lange-Hohmann , Knochenhebel	184
Lange-Hohmann modif. , Knochenhebel	184
Langenbeck , Amputationssägen	148
Elevatoren	176
Hüftgelenkhaken	220
Knochenhalte zangen	192
Ohrküretten	378
Raspatorien	170
Resektionssägen	148
Langenbeck , Wundhaken	220, 221
Lanzenmesser	314
Larry , Rektal-Sonden	436
Laryngoskope	386 – 390
Laryngoskope, Kaltlicht	391 – 395
Laryngoskop-Griffe	390
Laryngoskop-Griffe, Kaltlicht	395
Lateral Retraktor	446
Lateral Vaginal-Retraktoren	446
Laufe , Hämorrhoidal-Fasszangen	427
Lebsche , Sternummeißel	264
Sternumscheren	264
Le Grange , Augenscheren	49
Legue , Blasenspatel	420
Legueu , Blasenwundspreizer	421
Leksell-Stille , Hohlmeisselzangen	199
Hohlmeisselzangen	198
Scharfe Löffel	168
Leriche , Arterienklemmen	129
Lewin , Knochenhalte zangen	190
Lexer , Hohlmeissel	160, 161
Osteotome	161
Lidhalter	321
Ligaturschneider mit extraharten Einsätzen	114
Ligaturklemmen	130, 133
Ligaturscheren	57
Lister , Scheren mit HM-Schneiden	109
Sinusklemmen	143
Supercut-Scheren	61
Verbandscheren	63, 64
Lister-Burch , Sperreivatoren	320
Lister-Excentric , Verbandscheren	64
Liston , Knochensplitterzangen	206
Liston-Key , Knochensplitterzangen	206
Liston-Mini , Knochensplitterzangen	206
Littauer , Cilienpinzetten	40
Ligaturscheren	57
Polypenzangen	348
Littler , Präparierscheren	52
Lockhart-Mummery , Sonden	18
Lockwood-Allis , Darm- und Gewebefasszangen	407
Löffel, scharfe	164 – 169
Lorenz , Verbandscheren	63
Lorna , Tuchklemmen	140
Love , Nervwurzelhaken	290
Love-Gruenwald , Bandscheiben-Rongeure	297
Lovelace , Arterienklemmen	128
Lungenfasszangen	275
Lower , Gallenkanalklemmen	136
Lowman , Knochenhalteklammern	209
Lowman-Baby , Knochenhalteklammern	209
Lowman-Hoglund , Knochenhalteklammern	209
Luc , Siebbeinzangen	350
Lucae , Hämmer	186
Nasen- und Ohrpinzetten	349
Ohrhäkchen	379
Stimmgabeln	14
Lucae (Royce) , Parazentesenadeln	380
Lucas , Flachmeissel	157
Hohlmeissel	157
Luer , Hohlmeisselzangen	198, 200
Tracheal-Häkchen	398
Luer-Friedmann , Hohlmeisselzangen	200
Luer-Koerte , Gallensteinlöffel	418
Lukens , Tracheal-Häkchen	398
Lungen -fasszangen	275
-lappenscheren	53
-spatel	274
Lupusküretten	403
Lupuslöffel	403
Lupusschaber	403





SCHWERT
SWORD · ESPADA
EPEE · SPADA

Stichwortverzeichnis

M

Magenquetschklemmen	410
Maier , Korn- (Polypen-) zangen	144
Maltz , Nasenraspeln	359
Markham-Meyerding , Wundspreizer	247
Markierungszirkel	321
Marquardt , Hohlmeisselzangen	205
Martel , Einführungsinstrumente für Drahtsägen	279
Martin , Beckenzirkel	475
Uterussonden	453
Wundhaken	231
Martini , Scharfe Löffel	166
Masing , Septum- und Periost-Elevatorien	354
Masson , Nadelhalter	76
Nadelhalter mit HM-Einsätzen	106
Mastdarm-Spekula	429, 432, 433
Mastdarm-Biopsiezangen	434, 435
Mathieu , Fremdkörperzangen	422
Nadelhalter	77
Nadelhalter mit HM-Einsätzen	104, 105
Scheidenspekula	445
Wundhaken	239
Matson , Raspatorien	172
Maxi-Fasszangen	459
Mayfield , Hohlmeisselzangen	205
Mayo , Gallensteinlöffel	419
Gallensteinsonden	417
Präparierscheren	44
Scheren mit HM-Schneiden	110
Supercut-Scheren	59
Mayo-Blake , Gallensteinzangen	416
Mayo-Guyon , Nierenstielklemmen	136
Mayo-Harrington , Präparierscheren	44
Mayo-Hegar , Nadelhalter	74
Nadelhalter mit HM-Einsätzen	101
Mayo-Lexer , Präparierscheren	45
Scheren mit HM-Schneiden	110
Supercut-Scheren	59
Mayo-Noble, Präparierscheren	44
Mayo-Robson , Darmklemmen	408, 412
Mayo-Stille , Präparierscheren	44
Scheren mit HM-Schneiden	110
Supercut-Scheren	59
Mc Clure , Mikro-Scheren	322
Mc Donald , Elevatorien	176
Mc Givney , Hämorrhoidal-Fasszangen	426
Mc Guire , Hornhautscheren	323
Mc Indoe , Anatomische Pinzetten	26
Knochensplitterzangen	207
Knorpelscheren	54
Mc Intosh , Laryngoskope	386, 387, 391
Laryngoskope, Kaltlicht	391
Mc Ivor , Mundsperrer	368
Mc Kenty , Septum- und Periost-Elevatorien	354
Mc Lean-Tucker , Geburtszangen	476
Mc Pherson , Fadenpinzetten	308
Mead , Hämmer	187
Mead , Hohlmeisselzangen	202
Meissel	155 – 163, 356, 357
Mellinger , Sperrelevatorien	319
Mellinger-Axenfeld , Sperrelevatorien	319
Mellinger-Beard , Sperrelevatorien	319
Meniskotome	180
Meniskushaken	185
Messer	314
Diszisions-	314
Gips-	65
Iris-	314
Lanzen-	314
Mikro-	293
Nasenplastik-	363
Ring-	364
Schwing-	362
Star-	314
Tonsillen-	375
Trommelfell-	380
Metzenbaum , Präparierscheren	46
Scheren mit HM-Schneiden	111
Supercut-Scheren	60
Metzenbaum, Fino , Präparierscheren	47
Scheren mit HM-Schneiden	111
Supercut-Scheren	61
Metzenbaum-Lahey , Präparierscheren	47
Metzenbaum (Strabismus) , Präparierscheren	47
Scheren mit HM-Schneiden	110
Supercut-Scheren	61
Meyer , Fremdkörper-Hohlmeißel	315
Meyerding , Wundhaken	212, 236
Wundspreizer	246
Meyerding-Scoville , Laminektomiespreizer	303
Meyhoefer , Chalazionslöffel	318
M.G.H. , Nadelhalter	74
Michel , Wundklammer-Pinzetten	82
Wundklammer-Zangen	82
Micro-Friedmann , Hohlmeisselzangen	200
Middeldorpf , Wundhaken	224, 225
Middleton-Jansen , Septumzangen	351
Mikro	284
-Häkchen	284
-Hornhautscheren	322
-Knüpfpinzetten	39
-Messer	293
-Nadelhalter	80, 81
-Ohrzängchen	383
-Raspatorien	285
-Scheren	322, 326, 327
Mikulicz , Peritoneumklemmen	138
Wundhaken	234
Miller , Laryngoskope	388, 392, 393
Laryngoskope, Kaltlicht	392, 393
Milligan , Wundspreizer	243
Millin , Blasenwundspreizer	421
Kapsel Fasszangen	424
Mini-Friedmann , Hohlmeisselzangen	200
Mini-Gemini , Präparier- und Ligaturklemmen	133
Mini-Hohmann , Knochenhebel	181



SCHWERT
SWORD · ESPADA
EPEE · SPADA

Stichwortverzeichnis

Mini-Lambotte , Osteotome	156
Mini-Langenbeck , Wundhaken	214
Mini-Lexer , Hohlmeissel	161
Osteotome	161
Mini-Roux , Wundhaken	240
Mini-Tischler , Biopsiezangen	460
Mixer , Arterienklemmen	134, 135
Chirurgische Scheren	43
Gallensteinzangen	416
Mixer-Baby , Arterienklemmen	134
Mixer-O'Shaughnessy , Arterienklemmen	134
Mod. Bonn , Irispinzetten	307
Mod. Mayo-Russ , Thorax-Pinzetten	34
Mod. Russ , Thorax-Pinzetten	34
Mod. Tübingen , Wundhaken	231
Mod. USA , Nabelschnurscheren	52
Mollison , Wundspreizer	244
Molt , Mundsperrerr	366
Moore , Gallensteinlöffel	419
Morse , Rippensperrerr	268, 272
Morse-Favaloro , Rippensperrerr	272
Moynihan , Klemmzangen	137
Mueller , Sperrelewatoren	319
Mundsperrerr	366 – 370
Murdock , Sperrelewatoren	319
Murphy-Lane , Knochenheber	184
Museux , Hakenzangen	456
Myomheber	458

N

Nabatoff , Krampfaderbesteck	20
Nabelschnurscheren	52
Nachstarscheren	322
Nadelhalter	73 – 77
Augen-	78, 79
Augen- mit Hartmetall-Einsätzen	100
Mikro	80, 81
mit Hartmetall-Einsätzen	101 – 107
Nadeln Fremdkörper-	315
Parazentesen-	380
Reverdin-	93, 94
Star-	315
Unterbindungs-	83 – 89
Naegele , Geburtszangen	475
Nagel -ausreißzangen	482
-instrumente	479 – 482
-scheren	481
-spaltscheren	57
-zangen	481
Nahtpinzetten	309 – 311
Nasen -flügelhaken	360 – 362
-Osteotome	355 – 357
-pinzetten	349
-plastik-Messer	363
-raspeln	359
-sägen	358
-scheren	56, 341

Nasen -Septumzangen	350
-spekula	344 – 346
-zangen	366 – 340, 350
-zangen, scharfe	336, 337, 340
Neff , Meniskotome	180
Negus , Arterienklemmen	134
Mundsperrerr	369
Neivert , Nasenflügelhaken	362
Nélaton , Sonden	17
Nelson , Thorax-Pinzetten	34
News , Tracheal-Häkchen	398
Nierensteinzangen	415
Nierenstielklemmen	136
Noto , Uterus-Polypenzangen	457
Novak , Biopsieküretten	468
Novak-Schoeckaert , Biopsieküretten	469
Noyes, Iridektomiescheren	324

O

Obwegeser , Raspatorien	175
Ochsner-Kocher , Arterienklemmen	125
Ohr -häkchen	379
-instrumente, diverse	379
-küretten	377, 378
-pinzetten	349
-schlingen	378
-spekula	12
-zängchen	381 - 383
Oldberg , Bandscheiben-Rongeurs	296
Olivecrona , Dissektoren	288
Drahtsägen	279
Gewebspatel	282
Hohlmeisselzangen	202
Ollier , Wundhaken	218
Olsen-Hegar , Nadelhalter	75
Nadelhalter mit HM-Einsätzen	102, 106
Ombredanne , Hämmer	188
Ombredanne , Tuchklemmen	140
Osteotome	155 – 163
O'Sullivan-O'Connor , Bauchdeckenhalter	257
Oszillo-Einhandsägen	67 – 69
Oszillo-Sägen	67 – 69
Ovarien-Fasszangen	457
Overholt-Geissendoerfer , Präparier- u. Ligaturklemmen	130

P

Parametrium , Scheren mit HM-Schneiden	109
Parazentesenadeln	380
Parker , Wundhaken	240
Parker-Langenbeck , Wundhaken	239
Park-Guyton , Sperrelewatoren	319
Partsch , Flachmeissel	155
Hohlmeissel	155
Hämmer	187
Payr , Darm- und Magenquetschklemmen	410
Führungshohlsonden	92





SCHWERT
SWORD · ESPADA
EPEE · SPADA

Stichwortverzeichnis

Pean , Arterienklemmen	124
Pederson , Scheidenspekula	442
Pedicure-Zangen	480
Peers , Tuchklemmen	139
Peet , Splitterzangen	22
Penfield , Dissektoren	287
Penisklemmen	422
Pennington , Arterienklemmen	129
Septum- und Periost-Elevatorien	354
Percy , Amputations-Retraktoren	149
Periost-Elevatorien	354
Peritoneumklemmen	138
Perkussionshämmer	11, 12
Pflasterspatel	19
Phaneuf , Arterienklemmen	136
Pierce , Septum- und Periost-Elevatorien	354
Pinzetten	
Anatomische	25 – 28
Anatomische, fein	46
Anatomische, mit Hartmetall-Einsätzen	96, 97
Atrauma	35
Chalazions	311
Chirurgische	29 – 33
Chirurgische, mit Hartmetall-Einsätzen	97
Cilien-	40, 312
Entropium-	312
Faden-	308
Fixier-	306, 309
Iris-	306, 307
Kapsel-	308
Knüpf-	39, 312
mit Hartmetall-Einsätzen	96, 97
Naht-	309 – 311
Nasen-	349
Ohr-	349
Pinzetten	
Schweizer, extra fein	24
Splitter-	37, 38
Sterilisier-	146
Strabismus-	310, 311
Thorax-	34
Trachom-	311
Tumor-	39
Wundklammer-	82
Piper , Geburtszangen	476
Plazentazangen	477
Plester , Wundspreizer	243
Politzer , Parazentesenadeln	380
Polypenschnürer	347
Polypenzangen	143, 144, 348
Potts-Smith , Anatomische Pinzetten	27
Chirurgische Pinzetten	33
Gefäßscheren	53, 54
Pinzetten mit Hartmetall-Einsätzen	97
Präparierklemmen	130, 131, 133
Präparierscheren	44 – 47, 52, 54, 55
Presbyterian , Schlauchklemmen	141
Prince , Tonsillenscheren	56

Prince , Trachompinzetten	311
Proktoskope	428
Prostatahaken	423
Providence Hospital , Arterienklemmen	128
Putti , Knochenfeilen und -raspeln	179
Pylorusspreizer	408

Q

Quervain , Elevatorien	176
Quire , Fremdkörperhebel	384

R

Rabiner , Perkussionshämmer	12
Ragnell-Davis , Wundhaken	238
Ralk , Splitterzangen	22
Rampley , Schwammzangen	146
Randall , Nierensteinzangen	415
Raney , Anlege- und Abnehmezangen	281
Raspatorien	170 – 176, 379
Recamier , Uterusküretten	471
Reill , Mikro-Scheren	326
Reiner , Gipsmesser	65
Rektal -Absaugrohre	436
-Schnürer	437
-Sonden	436
Repositionszangen	192, 193
Resektionssägen	148, 149
Reverdin , Bauch- und Darmspatel	259
Reverdin-Nadeln	93, 94
Reynolds , Präparierscheren	54
Ricard , Bauchdeckenhalter	250
Richardson , Wundhaken	222
Richardson-Eastman , Wundhaken	223
Richter , Chirurgische Scheren	43
Rigby , Wundspreizer	247
Ringmesser	364
Rippen -kontraktoren	274
-scheren	262 – 264
-sperrer	265 – 273
Roberts , Arterienklemmen	131
Rochester-Carmalt , Arterienklemmen	126
Rochester-Pean , Arterienklemmen	124
Roeder , Tuchklemmen	139
Röttgen-Ruskin , Hohlmeisselzangen	199
Rose , Tracheal-Häkchen	398
Rosen , Elevatorien	379
Häkchen	379
Küretten	379
Raspatorien	379
Roser-König , Mundsperrer	366
Rotokürette , Biopsieküretten	468
Roux , Wundhaken	240
Rubin , Nasen-Osteotome	356
Septumzangen	343
Septumzangen mit Hartmetall-Einsätzen	343
Rumel , Präparierklemmen	131



SCHWERT
SWORD · ESPADA
EPEE · SPADA

Stichwortverzeichnis

Ruskin , Hohlmeisselzangen	198
Knochensplitterzangen	208
Ruskin-Liston , Knochensplitterzangen	208
Rust , Amputations- und Resektionssägen	149

S

Saalfeld , Komedoneninstrumente	404
Sachs , Dura-Dissektoren	289
Durahaken	293
Nervhaken	293
Sägen	66 – 71, 148, 149, 279, 358, 482
Sägegriffe	279
Saenger , Plazenta- und Abortuszangen	477
Salenius , Meniskotome	180
Sarot , Arterienklemmen	131
Nadelhalter	74
Nadelhalter mit Hartmetall-Einsätzen	106
Satinsky , Gefäßklemmen	276
Gefäßscheren	54
Satterlee , Amputations- und Resektionssägen	148
Sauerbruch , Hohlmeisselzangen	205
Rippenscheren	264
Wundhaken	221, 233
Sauerbruch-Frey , Rippenscheren	264
Saugrohre	436
Scalp Contour , Wundspreizer	242
Schädel , Tuchklemmen	139
Schädelhalter	280
Schädelzangen	279
Schamberg , Komedoneninstrumente	404
Scharfe Löffel	164 – 169
Schede , Scharfe Löffel	164
Scheidenspekula	439 – 445, 447
Scherbak , Scheidenspekula	447
Scheren Anatomie-	58
Augen-	49
Bauchdecken-	45
Bronchial-	55
Chirurgische	42, 43, 47, 50
Chirurgische, fein	50, 52
Damm-	51
Darm-	58
Draht-	57
für Geburtshilfe	51, 52
Gefäß-	53 – 55
Gips-	65
Gynäkologische	47, 50
Hornhaut-	323, 325
Inzisions-	43
Iridektomie-	324
Iris-	48, 49
Iris-, Ribbontype	328
Kephalotomie-	51
Knochen-	262, 264
Knorpel-	54
Ligatur-	57
Lungenlappen-	53
Scheren Mikro-	322, 326, 327
Mikro-Hornhaut-	322
mit HM-Schneiden	109 – 111
Nabelschnur-	52
Nachstar-	322
Nagel-	481
Nagelspalt-	57
Nasen-	56, 341
Präparier-	44 – 47, 52, 54, 55
Rippen-	262 – 264
Sehnen-	49, 323
Septum-	342
Sternum-	264
Supercut-	59 – 61
Tonsillen-	56
Uterus-	50
Verband-	63, 64
Schielhaken	317
Schilddrüsenhaken	398
Schink , Dermatomome	402
Schlauchklemmen	141, 142
Schlesinger , Bandscheiben-Rongeurs	294
Schmieden , Führungshohlsonden	91
Gefäßscheren	55
Unterbindungsnadeln	89
Schmieden-Dick , Unterbindungsnadeln	89
Schmieden-Payr , Führungshohlsonden	91
Schmidt , Tonsillenzangen	373
Schoenborn , Schilddrüsenhaken	398
Schraubendreher	151
Schröder , Hakenzangen	455
Schroeder, Uteruslöffel	474
Schröder-Braun , Hakenzangen	454
Schubert , Biopsiezangen	465
Schuhmacher , Biopsiezangen	462, 463
Schumacher , Biopsiezangen	464
Nabelschnurscheren	52
Schwammzangen	145, 146
Schwedisches Modell , Anatomische Pinzetten	25
Schweiger , Kapselpinzetten	308
Schweizer Pinzetten , extra fein	24
Schwingmesser	362
Scoville , Laminektomiespreizer	303
Gewebehaken	291
Scoville-Haverfield , Laminektomiespreizer	302
Sedillot , Raspatorien	170
Sehnen -fazzzangen	177
-führer	177
-schäler	177
-scheidenhaken	214
-scheren	49, 323
Seiler , Nasenscheren	56
Seitenschneider	154
Semb , Hohlmeisselzangen	203
Knochenhalte-zangen	191
Knochensplitterzangen	208
Raspatorien	173
Semken , Anatomische Pinzetten	26





SCHWERT
SWORD · ESPADA
EPEE · SPADA

Stichwortverzeichnis

Semken , Chirurgische Pinzetten	30	Spencer-Wells , Arterienklemmen	128
Semm , Scheidenspekula	443	Sperrelevatoren	319, 320
Senn-Green , Wundhaken	238	Sphinkteroskope	429
Senn-Miller , Wundhaken	238	Spinal , Scharfe Löffel	169
Separatoren	289, 290	Spinalhaken	185
Septum -Elevatoren	353, 354	Splitterpinzetten	37, 38
-Hohlmeißel	357	Splitterzangen	22
-Scheren	342	Spratt , Scharfe Löffel	164, 169
-Zangen	343, 350, 351	Spurling , Bandscheiben-Rongeurs	297
Sequesterzangen	190	Standard , Anatomische Pinzetten	25
Setter , Knochenhalte-zangen	191	Chirurgische Scheren	42
Seutin , Gips-scheren	65	Scheren mit HM-Schneiden	109
Sexton , Trommelfellmesser	380	Skalpelli-Griffe	116 – 118
Seyffert , Scheidenspekula	442	Skalpelli-klingen	119, 120
Shapleigh , Ohrküretten	378	Starmesser	314
Sieb-beinzangen	350	Starnadeln	315
Siebold , Uterus-scheren	50	Stau-de-Moore , Haken-zangen	455
Silver , Dermato-me	402	St. Clair-Thomson , Ring-messer	364
Nasen-Osteo-tome	357	St. Martin , Naht-pinzetten	310
Simon , Scharfe Löffel	167	Stellbrink , Hohlmeissel-zangen	201
Uterus-löffel	474	Sterilisierklammern	141
Wundhaken	231	Sterilisierpinzetten	146
Simpson-Braun , Geburts-zangen	475	Sterilisierzangen	146
Simpson-Luikart , Geburts-zangen	475	Sternmeißel	264
Sims , Chirurgische Scheren	50	Sternumscheren	264
Mast-darm-Spekula	432, 433	Stevens , Iris-pinzetten	307
Scheidenspekula	443	Sehnenscheren	49
Uterus-küretten	470	Supercut-Scheren	61
Uterus-sonden	453	Stevenson , Sperrelevatoren	320
Sims (Bodenhammer) , Mast-darmspekula	432	Stieglitz , Splitter-zangen	22
Singley-Tuttle , Thorax-Pinzetten	34	Stille , Flachmeißel	158
Sinus-klemmen	143	Gips-scheren	65
Sistrunk , Nagel-spalt-Scheren	57	Hohlmeißel	158, 159
Skalpelli-Griffe	116 – 118	Hohlmeissel-zangen	199
Skalpelli-klingen	119, 120	Osteo-tome	158, 159
Skene , Haken-zangen	454	Stille-Liston , Knochen-splitter-zangen	206
Sluder-Ballenger , Tonsil-lotome	376	Stille-Luer , Hohlmeissel-zangen	199
Smillie , Meniskotome	180	Stille-Ruskin , Hohlmeissel-zangen	203
Smith , Verbandscheren	63	Stimmgabeln	13 – 15
Smith-Buie , Analspreizer	430	Stockmann , Penis-klemmen	422
Smith-Petersen , Hohlmeißel	160	Strabismus (Metzenbaum) , Scheren mit HM-Schneiden	110
Hohlmeissel-zangen	204	Strabismus-pinzetten	310, 311
Osteo-tome	159	Strandell-Stille , Wundhaken	215
Smithwick , Gewebe-haken	292	Stratte , Nadelhalter	76
Snellen , Entropium-pinzetten	312	Nadelhalter mit HM-Einsätzen	104
Sonden	17 – 18	Strauss , Penis-klemmen	422
Augen-	313	Struempel , Ohrzängchen	381
Führungshohl-	90 – 92	Strully , Gefäß-scheren	55
Fistel-	18	Struycken , Scharfe Nasenzangen	340
Gallenstein-	417	Supercut-Scheren	59 – 61
Rektal-	436		
Uterus-	453		
Spekula Endo-	448, 449		
Mast-darm-	429, 432, 433		
Nasen-	344 – 346		
Ohr-	12		
Scheiden-	439 – 445, 447		
Spencer , Ligatur-scheren	57		

T

Takahashi , Scharfe Nasenzangen	337
Taylor , Chirurgische Pinzetten	32, 33
Taylor , Anatomische Pinzetten	27
Laminektomiespreizer	303
Perkussions-hämmer	11





SCHWERT
SWORD · ESPADA
EPEE · SPADA

Stichwortverzeichnis

Taylor , Spinalhaken	185
TC-Rubin , Septumzangen	343
Teale , Hakenzangen	456
Temple-Fay , Bauchdeckenhalter	258
Thomas , Tuchklemmen	141
Uterusküretten	470
Thoms-Allis , Darm- und Gewebefasszangen	406
Thoms-Gaylor , Biopsiezangen	467
Thorax-Pinzetten	34
Thudichum (Goldsmith) , Nasenspekula	346
Tieck-Halle , Nasenspekula	344
Tischler , Biopsiezangen	460, 466
Tischler-Kevorkian , Biopsiezangen	460
Tobold , Zungenspatel	371
Tönnis , Präparierscheren	54
Toennis , Dissektoren	288
Gefäßhaken	293
Hauthaken	293
Mikromesser	293
Tönnis-Adson , Scheren mit HM-Schneiden	111
Tonsillen-dissektoren	375
-enukleatoren	375
-messer	375
-retraktoren	375
-scheren	56
-schnürer	374
-zangen	373
Tonsillotome	376
Tracheal-Dilatatoren	397
-Häkchen	397, 398
Trachompinzetten	311
Tränenkanal-Dilatatoren	317
Traube , Perkussionshämmer	11
Troeltsch (Wilde) , Nasen- und Ohrpinzetten	349
Troemner , Perkussionshämmer	11
Trommelfellmesser	380
Trousseau , Tracheal-Dilatatoren	397
Troutman , Mikro-Hornhautscheren	322
Tuchklemmen	139 – 141
Tübinger Modell , Wundspreizer	244
Tuffier , Bauch- und Darmspatel	259
Rippensperrerr	270
Tumorpinzetten	39
Tupferträger	437
Tupferzangen	143 – 145
Tyding , Tonsillenschnürer	374

U

Watteträger	19
Ulrich , Knochenhalte-zangen	197
Tupferzangen	143
Uni-Burke , Biopsiezangen	462, 463
Uni-Kevorkian , Biopsiezangen	462, 463
Uni-Oval , Biopsiezangen	462, 463
Uni-Tischler , Biopsiezangen	462, 463
Uni-Townsend , Biopsiezangen	462, 463
Universal , Drahtkneifzangen mit HM-Einlagen	112

Universal , Drahtscheren	57
Unna , Komedoneninstrumente	404
Unna-Vidal , Komedoneninstrumente	404
Unterbindungsnadeln	83 – 89
USA-Modell , Anatomische Pinzetten	26
Chirurgische Pinzetten	29, 30
Gippspreizer	66
Nabelschnurscheren	52
USA-Mod. Standard , Anatomische Pinzetten	26
Uterus -Depressoren	453
-dilatatoren	450 – 452
-Fasszangen	457, 458
-klemmzangen	478
-küretten	470 – 473
-löffel	474
-Polypenzangen	457
-scheren	50
-sonden	453

V

Vannas , Mikro-Scheren	326
Nachstarscheren	322
Van Buren , Knochenhalte-zangen	192
Van Doren , Biopsiezangen	467
Verbandscheren	63, 64
Verbrugge , Knochenhalte-zangen	196, 197
Verbrugge-Baby , Knochenhalte-zangen	196
Vidal , Lupusschaber	403
Vogel , Ringmesser	364
Volkmann , Scharfe Löffel	164, 165, 168
Wundhaken	215 – 217

W

Wachenfeldt , Wundklammer-Pinzetten	82
Wagener , Ohrhäkchen	379
Wagner , Laminektomie-zangen	296
Raspatorien	171
Waldmann , Dammscheren	51
Walter , Nasen-Osteotome	356
Walter-Carmalt , Splitterpinzetten	38
Wangensteen , Nadelhalter	76
Nadelhalter mit HM-Einsätzen	103
Pinzetten mit HM-Einsätzen	97
Wassmund , Wundhaken	218
Watson-Cheyne , Sonden	18
Watteträger	437
Wagh , Anatomische Pinzetten	28
Chirurgische Pinzetten	32
Webster , Nadelhalter	73
Nadelhalter mit HM-Einsätzen	104
Weil-Blakesley , Scharfe Nasenzangen	336
Weitlaner-Baby , Wundspreizer	242
Weitlaner-Loktite , Wundspreizer	242
Weitlaner-Wullstein , Wundspreizer	242
Wertheim , Chirurgische und Gynäkologische Scheren	47
Klemmzangen	137, 138





SCHWERT
SWORD · ESPADA
EPEE · SPADA

Stichwortverzeichnis

Wertheim-Cullen , Klemmzangen	137
Wessely-Grieshaber , Lanzenmesser	314
Westcott , Sehnenscheren	323
Westmacott , Nasenzangen	350
White , Tonsillenzangen	373
Whitehead , Mundsperrer	366
Wieder , Zungenspatel	371
Wien , Nasenspekula	346
Wiener , Augenhäkchen	316
Nasenspäpeln	359
Wilde , Scharfe Nasenzangen	340
Wilder , Tränenkanal-Dilatatoren	317
Williams , Darmfasszangen	407
Sperrhelevatoren	319
Williger , Elevatorien	176
Hämmer	186
Raspatorien	171
Scharfe Löffel	165, 166
Winter , Plazenta- und Abortuszangen	477
Wirbelkörperspreizer	281
Wittner , Biopsiezangen	464
Wolff , Gipsabreißzangen	66
Lupuslöffel	403
Wund	
-haken	211 – 240
-klammer-Pinzetten	82
-klammer-Zangen	82
-sperrer	249
-spreizer	241 – 248
Wurzelhaken	290

Y

Yasargil , Fadenführer	283
Galeahaken	286
Mikro-Raspatorien	285
Scharfe Hypophysenzangen	296
Tumorzangen	39
Yeoman , Mastdarm-Biopsiezangen	434
Yeoman (Turrell) , Mastdarm-Biopsiezangen	435
Young , Prostatahaken	423
Zungenzangen	372

Z

Zangen	
Abortus-	477
Anlege- und Abnehme-, für Kopfhautklammern	281
Biopsie-	460 – 467
Bohrer-, Führungs- und Dura-Schutz	150
Darm- und Gewebefass-	406, 407
Draht-	153, 154
Fass-	459
Flach-	152, 153
Fremdkörper-	422
Gallenstein-	416
Geburts-	475, 476
Gewebefass-	406, 407
Gewebefass-, mit HM-Einsätzen	108
Gipsabreiß-	66

Zangen	
Haken-	454 – 456
Haut-	480
Hämorrhoidal-Fass	426
Hohlmeissel-	198 – 205
Hypophysen-	296
Kapselfass-	424
Klammer-Anlege	281
Klemmschließ-	410
Klemm-	137, 138
Knochenhalte-	190 – 197
Knochensplitter-	206 – 208
Knorpelfass-	190, 191
Korn- (Polypen-)	143, 144
Kropffass-	399
Laminektomie-	295, 296
Lungenfass-	275
Mastdarm-Biopsie-	434, 435
Nagel-	481
Nagelausreiß-	482
Nasen-	336 – 340, 350
Nasen-Septum-	350
Nierenstein-	415
Ohr-	381 – 383
Ovarien-Fass	457
Pedicure-	480
Plazenta-	477
Polypen-	143, 144, 348
Repositions-	192, 193
Schädel-	279
Schwamm-	145, 146
Sehnenfass-	177
Septum-	343, 350, 351
Sequester-	190
Siebbein-	350
Splitter-	22
Sterilisier-	146
Tonsilen-	373
Tupfer-	143 – 145
Uterus-Fass	457, 458
Uterusklemm-	478
Uterus-Polypen-	457
Wundklammer-	82
Zungen-	372
Zaufal , Hohlmeisselzangen	201
Zaufal-Jansen , Hohlmeisselzangen	203
Zenker , Präparier- und Ligaturklemmen	133
Wundhaken	228
Ziegler , Irismesser	314
Zungenspatel	371
Zungenzangen	372



SCHWERT
SWORD · ESPADA
EPEE · SPADA

Alphabetical Index

A

Abdominal	
Retractors	247, 248, 250 – 258
Scissors	45
Spatula	259, 260
Adenoid Curettes	364
Adenotomes	365
Adlerkreutz , Tissue Forceps	30
Adson , Bone Rongeur Forceps	203
Dressing Forceps	26
Dressing Forceps with T/C jaws	97
Drill Forceps	150
Drill Guide Forceps	150
Hemostatic Forceps	129
Needle Holders	77
Periosteal Raspatories	175
Retractors	245, 246
Skin Hooks	293
Tissue Forceps	30
Tissue Forceps with T/C jaws	97
Vascular protecting forceps	150
Vessel Hooks	293
Adson-Baby , Retractors	244
Adson Brown , Tissue Forceps	31
Tissue Forceps with T/C jaws	97
Adson-Tönnis , Dissecting Scissors	55
Akku Plaster Saws	68, 69
Alan Parks , Anal Retractors	431
Alexander , Biopsy Punches	467
Bone Chisels	156
Gouges	156
Periosteal Raspatories	172
Allis , Intestinal and Tissue Grasping Forceps	407
Tissue Seizing Forceps with T/C jaws	108
Allis-Adair , Intestinal and Tissue Grasping Forceps	406
Allis-Baby , Intestinal and Tissue Grasping Forceps	406
Allison , Lung Spatula	274
Alm , Eye Specula	320
Amputating	
Retractors	149
Saws	148, 149
Anal Retractors	430, 431
Anastomosis Clamp Forceps	409
Anderson-Adson , Retractors	249
Andrew , Tongue Depressors	371
Antrum Punch Forceps	352
Anusopes	427
Arruga , Capsular Forceps	308
Eye Needle Holders	78 - 79
Eye Needle Holders with T/C jaws	100
Arthur , Splinter Forceps	22
Asch , Septum Forceps	343
Atrauma Forceps	35
Atraumatic Bulldog Clamps	122
Aufricht , Hooks for posterior nares	360
Nasal Rasps	359
Auvard , Vaginal Specula	447

Ayer , Chalazion Forceps	311
---------------------------------	-----

B

Babcock , Intestinal Grasping Forceps	407
Tissue Seizing Forceps with T/C jaws	108
Babinsky , Percussion Hammers	11
Baby-Adson , Hemostatic Forceps	129
Baby-Collin , Abdominal Retractors	251
Baby-Crile , Hemostatic Forceps	128
Baby-Kern , Bone Holding Forceps	193
Baby-Lexer , Dissecting Scissors	45
Baby-Olsen-Hegar , Needle Holders	75
Needle Holders with T/C jaws	107
Baby-Roux , Retractors	240
Baby-Satinsky , Blood Vessel Clamps	277
Baby-Senn-Miller , Retractors	238
Baby-Tischler , Biopsy Punches	460
Backhaus , Towel Forceps	139
Baggish , Biopsy Punches	461
Bailey , Rib Contractors	274
Bailey-Baby , Rib Contractors	274
Bailey-Gibbon , Rib Contractors	274
Bainbridge , Hemostatic Forceps	126
Bakes , Bile Duct Dilators	417
Balfour , Abdominal Retractors	253, 254
Balfour-Baby , Abdominal Retractors	253
Ballenger , Swivel Knives	362
Ballenger-Hajek , Septum Elevators	353
Bandage Scissors	63, 64
Bane (Hartmann) , Bone Rongeur Forceps	202
Barnhill , Adenoid Curettes	364
Barr , Rectal Specula	429
Barraquer , Cilia Forceps	312
Eye Needle Holders	79
Eye Needle Holders with T/C jaws	100
Fixation Forceps	309
Barth , Ear Curettes	378
Baumgartner , Needle Holders with T/C jaws	103
Beaupré , Cilia Forceps	312
Beckmann , Adenoid Curettes	364
Retractors	245
Beckmann-Adson , Retractors	249
Beckmann-Eaton , Retractors	249
Beer , Cilia Forceps	40
Bellucci , Ear Polypus Forceps	382
Bengolea , Hemostatic Forceps	132
Bennett , Bone Levers	184
Benson , Pylorus Spreaders	408
Berger , Biopsy Punches	466
Bergmann , Bandage Scissors	64
Mallets	188
Berliner , Percussion Hammers	11
Bernhard , Towel Forceps	140
Bethune , Rib Shears	263
Beyer , Bone Rongeur Forceps	198, 202
Bile Duct Dilators	417
Billeau , Ear Loops	378





SCHWERT
SWORD · ESPADA
EPEE · SPADA

Alphabetical Index

Biopsy Curettes	468, 469	Bumm , Uterine Curettes	472
Biopsy Punches	460 – 467	Bunge , Exenteration Scoops	318
Bircher , Meniscotomy Knives	180	Bunnell , Tendon Passing Instruments	177
Bircher-Ganske , Cartilage Seizing Forceps	191	Tendon Strippers	177
Bishop-Harmon , Iris Forceps	307	Bunt , Sterilizing Holders	141
Bladder Retractors	420, 421	Burford , Rib Spreaders	266
Blake , Gall Stone Forceps	416	Burke , Biopsy Punches	461
Uterine Curettes	473	Busch , Umbilical Scissors	52
Blohmke , Tonsil Seizing Forceps	373		
Blood Vessel Clamps	276, 277	C	
Blount , Bone Levers	185		
Meniscus Retractors	185	Caplan , Septum Scissors	342
Blumenthal , Bone Rongeur Forceps	201	Capsular Forceps	308
Böhler , Bone Cutting Forceps	207	Capsule Forceps	424
Bone Rongeur Forceps	203	Caroll , Tendon Instruments	177
Böttcher , Tonsil Scissors	56	Carpenter , Tonsil Enucleators	375
Bonaccolto , Strabismus Forceps	310	Tonsil Knives	375
Bone		Cartilage Scissors	54
Chisels	155 – 163	Cartilage Seizing Forceps	190, 191
Curettes	164 – 169	Caspar , Laminectomy Rongeurs	295
Cutting Forceps	206 – 208	Castañeda , Rib Spreaders	268
Files	178, 179	Castroviejo , Corneal Scissors	323, 325
Gouges	155 – 163	Eye Needle Holders	78
Holding Clamps	209	Eye Needle Holders with T/C jaws	100
Holding Forceps	190 – 197	Eye Specula	320
Levers	181 – 185	Markers graduated	321
Osteotomes	155 – 163	Suture Forceps	309 – 311
Rasps	179	Cataract Knives	314
Rongeur Forceps	198 – 205	Cataract Needles	315
Shears	262, 264	Catheter Introducing Instruments	419
Bonney , Tissue Forceps	33	Cephalotomy Scissors	51
Bose , Trachea Retractors	397	Cervical Traction Tongs	280
Bowman , Eye Specula	320	Chalazion Curettes	318
Lachrymal Probes	313	Chalazion Forceps	311
Bozemann , Cotton Swab Forceps	144	Charrière , Amputating- and Resection Saws	148
Needle Holders with T/C jaws	107	Chelsea Eaton , Proctoscopes	428
Boys-Allis , Intestinal and Tissue Grasping Forceps	406	Cheron , Cotton Swab Forceps	145
Brand , Tendon Instruments	177	Cilia Forceps	40, 312
Braun , Tenaculum Forceps	454	Chisels	155 – 158, 162, 356, 357
Uterine Depressors	453	Cinelli , Nasal Osteotomes	356
Braun-Stadler , Perineum Scissors	51	Circumcision Instruments	422
Breisky , Vaginal Specula	444	Clamp Closing Forceps	410
Bronchial Scissors	55	Clamp Forceps	137, 138
Brophy , Dressing Forceps	28	Clamp Holders	410
Tissue Forceps	32	Clamps Blood Vessel	276, 277
Brown , Needle Holders	73	Bone Holding	209
Bruenings , Tongue Depressors	371	Bulldog	122
Tonsil Snare	374	Gall Duct	135, 136
Brunner , Ligature Conductors	90	Intestinal	410
Retractors	234, 235	Kidney Pedicle	136
Rib Shears	263	Stomach	410
Bruns , Bandage Scissors	64	Tubing	141, 142
Bone Curettes	164, 165	Cleveland , Bone Cutting Forceps	207
Buchwald , Tongue Depressors	371	Bone Rongeur Forceps	200
Buck , Ear Curettes	377	Clip Applying Forceps	82, 281
Foreign Body Levers	384	Cloward , Intervertebral Disc Rongeurs	294
Percussion Hammers	12	Lamina Spreaders	281
Buie , Rectal Aspiration Cannulas	436	Laminectomy Spreaders	304
Bulldog Clamps	122		





SCHWERT
SWORD · ESPADA
EPEE · SPADA

Alphabetical Index

- Colclough(Richter)**, Intervertebral Disc Rongeurs 300, 301
Collier, Needle Holders 73
Collin, Abdominal Retractors 251
Clip Applying Forceps 82
Cotton Swab Forceps 145
Mallets 186
Pelvimeters 475
Retractors 239
Tongue Holding Forceps 372
Vaginal Specula 442
Collin-Loktite, Abdominal Retractors 250, 251
Comedo Extractors 404
Conductor for wire saws 279
Cone, Retractors 244
Converse, Hooks for posterior nares 360
Cooley, Rib Spreaders 267, 271
Cooper, Ligature Needles 89
Coppelson, Biopsy Punches 460
Corneal Scissors 323, 325
Coryllos, Retractors 232
Cottle, Hooks for posterior nares 360 – 362
Mallets 187
Nasal and Ear Dressing Forceps 349
Nasal Osteotomes 355
Nasal Rasps 359
Nasal Specula 345
Rhinoplastic and Nasal Knives 363
Septum and Periosteal Elevators 354
Cottle-Neivert, Hooks for posterior nares 361
Cotton Applicators 437
Cotton Swab Forceps 143 – 145
Crafoord, Hemostatic Forceps 131
Lobectomy Scissors 53
Crile, Hemostatic Forceps 127
Needle Holders 77
Nerve Hooks 292
Retractors 214
Crile-Rankin, Hemostatic Forceps 127
Crile-Wood, Needle Holders 73, 75
Needle Holders with T/C jaws 103
Crutchfield, Cervical Traction Tongs 280
Curettes 353, 379
Adenoid 364
Biopsy 468, 469
Bone 164 – 169
Chalazion 381
Ear 377, 378
Lupus 403
Uterine 470 – 474
Cusco, Vaginal Specula 441
Cushing, Decompression Hooks 215
Dressing Forceps 28
Forceps with T/C jaws 97
Intervertebral Disc Rongeurs 297
Retractors 213
Skin Hooks 293
Tissue Forceps 32
Tissue Hooks 292
Cushing, Tissue Spatula 282
Vessel Hooks 293
Cuticle Instruments 480
Cuticle Nippers 480
Czerny, Rectal Specula 432
Tenaculum Forceps 455
- ## D
- Dahlgren**, Scull-Cutting Forceps 279
Dandy, Dissecting Scissors 55
Tissue Hooks 292
Dandy Crile, Hemostatic Forceps 128
Dartigues, Uterine Elevating Forceps 458
Dastoor, Erisophakes 308
Daubenspeck, Bone Curettes 167
Davidson, Retractors 233
Davis, Dissectors 289
Sterilizing Forceps 146
Davis-Boyle, Mouth Gags 367, 369
Dean, Tonsil Scissors 56
Deaver, Operating Scissors 43
Retractors 229, 230
De Bakey, Atrauma Forceps 35
Needle Holders with T/C jaws 103
Retractors 248
Decompression Hooks 215
Déjerine, Percussion Hammers 12
De Martel-Wolfson, Anastomosis Clamp Forceps 409
Clamp Closing Forceps 410
Clamp Holders 410
Denhart, Mouth Gags 366
Denis-Browne, Abdominal Retractors 256
Derf, Needle Holders 73
Derf, Needle Holders with T/C jaws 101
Dermal Punches 401
Dermatomes 402
Deschamps, Ligature Needles 83 – 87
Desjardins, Gall Duct Clamps 136
Gall Stone Forceps 416
Gall Stone Probes 417
Gall Stone Scoops 419
Desmarres, Chalazion Forceps 311
Lid Retractors 321
De Vilbiss, Scull-Cutting Forceps 279
Dieffenbach, Bulldog Clamps 122
Dingmann, Cartilage Seizing Forceps 190
Directors 436
Dissection Knives 314
Dissecting Forceps 130, 131, 133
Dissecting Scissors 44 – 47, 52, 54, 55
Dissectors 287 – 289
Dix, Needles and Chisels 315
Needles and Gouges 315
Douglas, Cilia Forceps 40
Doyen, Abdominal Scissors 45
Intestinal Clamp Forceps 408, 411
Mallets 186





SCHWERT
SWORD · ESPADA
EPEE · SPADA

Alphabetical Index

Doyen , Myoma Screws	458
Ovarian Elevating Forceps	457
Periosteal Raspatories	172
Probes and Directors	17
Retractors	226
Tongue Depressors	371
Towel Forceps	139
Vaginal Specula	444, 445
Doyen-Stille , Retractors	224
Dressing Forceps	25 – 28
Dressing Forceps, delicate	36
Dressing Forceps with T/C jaws	96, 97
Drill Guide and Dura Protecting Forceps	150
Dubois , Cephalotomy Scissors	51
Duplay , Polypus and Dressing Forceps	144
Tenaculum Forceps	454
Duval , Lung Grasping Forceps	275
Tissue Seizing Forceps with T/C jaws	108

E

Ear	Curettes	377, 378
	Dressing Forceps	349
	Hooks	379
	Instruments, miscellaneous	379
	Loops	378
	Polypus Forceps	381, 383
	Specula	12
Echlin , Bone Rongeur Forceps	204	
Eder , Cotton Applicators	437	
Elliot , Obstetrical Forceps	476	
Elschnig , Fixation Forceps	306	
Endospecula	448, 449	
Engel , Plaster Saws	66	
Engl. Mod. , Dressing Forceps	26	
Enterotomy Scissors	58	
Entropium Forceps	312	
Eppendorf , Biopsy Punches	464	
Erisophakes	308	
Esmarch , Bandage Scissors	63	
Plaster-of-Paris Knives	65	
Ethmoid Forceps	350	
Eves , Tonsil Snares	374	
Eye	Hooks	316
	Knives	314
	Needle Holders	78, 79
	Needle Holders with T/C jaws	100
	Scissors	49
	Specula	319, 320
Exenteration Scoops	318	

F

Farabeuf , Bone Holding Forceps	192
Periosteal Raspatories	170
Retractors	239
Farabeuf-Lambotte , Bone Holding Forceps	192
Farrell (Lathbury) , Cotton Applicators	19

Faulkner , Curettes	353
Faure , Peritoneal Clamp Forceps	138
Feilchenfeld , Splinter Forceps	38
Fergusson , Bone Holding Forceps	192
Ferris-Smith-Kerrison , Intervertebral Disc Rongeurs	299
Fine Swiss Tweezers	24
Finger Ring Saws	482
Finocchietto , Needle Holders	76
Needle Holders with T/C jaws	103
Rib Spreaders	265, 269
Finocchietto-Baby , Rib Spreaders	269
Finocchietto-Baby-Haight , Rib Spreaders	265
Finocchietto-Burford , Rib Spreaders	270
Finocchietto-Infant , Rib Spreaders	265
Finsen , Retractors	241
Fisch , Micro Hooks	284
Fischer , Iris Forceps	306
Fistula Probes	18
Flat Nose Pliers	152, 153
Foerster , Sponge Holding Forceps	145
Fomon , Hooks for posterior nares	361
Fomon , Nasal Osteotomes	356
Nasal Rasps	359
Nasal Scissors	56
Rhinoplastic and Nasal Knives	363
Forceps Applying and Removing, for Scalp Hemostasis Clips	381
Anastomosis Clamp	409
Antrum Punch	352
Atrauma	35
Bone Cutting	206 – 208
Bone Holding	190 – 197
Bone Rongeur	198 – 205
Capsular	308
Capsule Forceps	424
Cartilage Seizing	190, 191
Chalazion	311
Cilia	40
Clamp	137, 138
Clamp Closing	410
Clip Applying	82, 281
Cotton Swab	143 – 145
Dissecting	130, 131, 133
Dressing	25 – 28
Dressing, delicate	36
Dressing, with T/C jaws	96, 97
Drill Guide and Dura Protecting	150
Ear Dressing	349
Ear Polypus	381 – 383
Entropium	312
Ethmoid	350
Fixation	306, 309
for tearing out toe and finger nails	482
Foreign Body	422
Gall Stone	416
Goitre Grasping	399
Grasping	459
Haemorrhoidal	426
Hemostatic	122 – 132, 134 – 136



SCHWERT
SWORD · ESPADA
EPEE · SPADA

Alphabetical Index

Forceps Hysterectomy	137	Franz , Abdominal Retractors	255
Intestinal Clamp	408, 409, 411 – 413	Frazier , Abdominal Retractors	258
Intestinal	406 – 407	Separators	289
Iris	306, 307	Skin Hooks	293
Kidney Stone	415	Vessel Hooks	293
Ligature	130, 133	Freer , Chisels	357
Lung Grasping	34, 275	Hooks for posterior nares	361
Micro Ear Polypus	383	Septum Elevators	353
Nasal	336 – 340, 348 – 350	Septum Gouges	357
Nasal Cutting	336, 337, 340	French , Needle Holders with T/C jaws	101
Nasal Septum	350	French-Mathieu , Needle Holders with T/C jaws	105
Nasal Polypus	348	Fritsch , Retractors	225
Obstetrical	475, 476		
Ovarian Elevating	457	G	
Ovum	477		
Penis Seizing	422	Galea Hooks	386
Peritoneal Clamp	138	Gallaher, Bone Files	178
Placenta	477	Gall Duct Clamps	135, 136
Polypus and Dressing	143, 144	Stone Forceps	416
Punch	339	Stone Probes	417
Rectal Biopsy Specimen Forceps	434, 435	Stone Scoops	4, 419
Reposition	192, 193	Gelpi-Loktite , Retractors	248
Scull Cutting	279	Gemini , Dissecting and Ligature Forceps	133
Septum	343, 350, 351	Gerald , Dressing Forceps	27
Sequestum	190	Dressing Forceps with T/C jaws	97
Sinus	143	Tissue Forceps	31
Splinter	22, 37, 38	Tissue Forceps with T/C jaws	97
Sponge Holding	145, 146	Giertz-Stille , Rib Shears	263
Sterilizing	146	Gigli , Wire Saws	279
Strabismus	310, 311	Saw Handles	279
Suture	308 – 311	Gill , Iris Forceps	306
Suture Tying	312	Gill-Arruga , Capsular Forceps	308
Swiss Tweezers, fine	24	Gill-Hess , Iris Forceps	306
Tenaculum	454 – 456	Gillies , Hooklets	403
Tissue Grasping	406 – 407	Needle Holders	74
Tissue	29 – 33	Needle Holders with T/C jaws	107
Tissue, with T/C jaws	97	Tissue Forceps	31
Tissue Seizing, with T/C jaws	108	Gillies-Baby , Needle Holders with T/C jaws	107
Tongue Holding	372	Glover , Atraumatic Bulldog Clamps	122
Tonsil Seizing	373	Gluck , Rib Shears	262
Towel	139 – 141	Goitre Grasping Forceps	399
Trachoma	311	Goldmann-Fox , Operating Scissors	43
Tumor	39	Goldstein , Eye Specula	319
Uterine Elevating	457, 458	Good , Tonsil Scissors	56
Uterine Hemostasis	478	Gosset , Abdominal Retractors	252
Uterine Polypus	457	Gouges	155 – 161, 163, 357
Wire Seizing	113	Gouges for foreign bodies	315
with T/C jaws	96, 97	Gradle , Cilia Forceps	312
Foregger , Laryngoscopes	389, 394	Graefe , Cataract Knives	314
Laryngoscopes, cold light	394	Eye Hooks	316
Foreign Body		Iris Forceps	306
Forceps	422	Iris Scissors	49
Instruments	315, 316	Needles and Gouges	316
Levers	384	Strabismus Hooks	317
Needles	315	Graham , Skin Hooks	293
Fox , Lupus Curettes	403	Vessel Hooks	293
Fracture Fixation Splints	372	Graig , Nasal Septum Forceps	350
Frankenfeld , Rectal Snares	437	Grasping Forceps	459



SCHWERT
SWORD · ESPADA
EPEE · SPADA

Alphabetical Index

Grave , Vaginal Specula	441
Grazil , Operating Scissors	42
Green , Fixation Forceps	309
Tubing Clamps	141
Green-Armytage , Uterine Hemostasis Forceps	478
Gross , Polypus and Dressing Forceps	143
Grünwald-Jansen , Nasal and Ear Dressing Forceps	349
Guthrie , Eye Hooks	316
Guyon , Catheter Introducing Instruments	419
Gynecological Scissors	47, 50

H

Haberer , Abdominal and Intestinal Spatula	259
Haemorrhoidal Forceps	426
Haglund-Stille, Plaster Cast Instruments	66
Haight , Rib Spreaders	270
Hajek , Mallets	187
Sphenoid Punches	352
Halle , Bone Curettes	168
Dura Knives	293
Halsey , Needle Holders	87
Needle Holders with T/C jaws	104
Halsted-Mosquito , Hemostatic Forceps	125
Handles for laryngeal mirrors	10
Hank , Uterine Dilators	452
Harken , Blood Vessel Clamps	277
Rib Spreaders	273
Harrington , Retractors	230
Hartmann , Ear Polypus Forceps	381, 382
Ear Specula	12
Hemostatic Forceps	122
Nasal Polypus Forceps	348
Nasal Specula	344
Tuning Forks	13
Hartmann-Halle , Nasal Specula	344
Hartmann-Noyes , Ear Polypus Forceps	381
Hartmann-Weingärtner , Ear Polypus Forceps	381
Heaney , Hysterectomy Forceps	137
Needle Holders	76
Needle Holders with T/C jaws	104
Heaney-Ballentine , Hysterectomy Forceps	137
Heath , Wire Cutting Scissors	57
Hegar , Needle Holders with T/C jaws	102
Uterine Dilators	450 – 452
Hegar-Baumgartner , Needle Holders	74
Hegenbarth , Clip Applying Forceps	82
Heifetz , Brain Spatula	282
Tumor Forceps	39
Heiss , Hemostatic Forceps	130
Heister , Mouth Gags	366
Helferich-Bier , Amputating- and Resection Saws	149
Hemostatic Forceps	122 – 132, 134– 136
Henke , Tonsil Dissectors	375
Henning , PlasterCast Instruments	66
Hess , Iris Forceps	307
Heymann , Nasal Scissors	56
Heymann-Knight , Nasal Polypus Forceps	348

Hibbs , Bone Chisels	162
Hibbs , Gouges	163
Osteotomes	162, 163
Hirschmann , Anusscopes	427
Hoel , Separators	289
Hösel , Retractors	227
Hohmann , Bone Levers	182, 183
Hoke , Osteotomes	162
Holsher , Nerve Root Retractors	291
Holtzheimer , Retractors	241
Holzbach , Abdominal Retractors	250
Hooks Decompression	215
Delicate	284
Ear	379
Eye	316
for posterior nares	360 – 362
Galea	286
Micro	284
Skin	293
Strabismus	283, 293
Vessel	303
Hooklets	379, 403
Hopkins , Plaster-of-Paris Knives	65
Horsley , Dura Dissectors	290
Howarth , Periosteal Raspatories	171
Hunter , Splinter Forceps	38
Hurd , Tonsil Dissectors	375
Tonsil Retractors	375
Hylin , Periosteal Raspatories	173
Hysterectomy Forceps	137

I

Incision Scissors	43
Inge , Lamina Spreaders	281
Inge-Lamina , Lamina Spreaders	281
Instruments for Cranial Opening	279
Intervertebral Disc Rongeurs	294, 296 – 299
Intestinal	
Clamps	410
Clamp Forceps	409, 411 – 413
Forceps	406, 407
Spatula	259, 260
Iridectomy Scissors	324
Iris	
Forceps	306, 307
Knives	314
Scissors	48, 49
Scissors "Ribbon type"	328
Scissors with tungsten carbide edges	111
Supercut Scissors	61
Israel , Retractors	219
Ibson , Trachea Retractors	397
Ives-Fansler , Anusscopes	427

J

Jackson , Trachea Retractors	398
Jaeger , Eye Hooks	316



SCHWERT
SWORD · ESPADA
EPEE · SPADA

Alphabetical Index

Jakobs , Tenaculum Forceps	456
Jansen , Bone Rongeur Forceps	201
Ear Curettes	378
Nasal and Ear Dressing Forceps	349
Periosteal Raspatories	173
Retractors	241
Jennings , Mouth Gags	366
Jobson-Horne , Cotton Applicators	19
John Hopkins , Bulldog Clamps	122
Jones , Towel Forceps	139
Joseph , Bone Files	178
Delicate Operating Scissors	52
Hooks for posterior nares	360, 361
Nasal Saws	358
Periosteal Raspatories	176
Rhinoplastic and Nasal Knives	363
Septum and Periosteal Elevators	354
Joseph-Masing , Septum Elevators	353
Judd-Allis , Intestinal and Tissue Grasping Forceps	406
Judd-Masson , Bladder Retractors	421

K

Kader , Abdominal and Intestinal Spatula	260
Kallmorgen , Vaginal Specula	443
Kalt , Eye Needle Holders	79
Eye Needle Holders with T/C jaws	100
Kantrowitz , Hemostatic Forceps	135
Katzin , Corneal Scissors	323
Kelly , Delicate Operating Scissors	50
Hemostatic Forceps	127
Proctoscopes	428
Retractors	222, 238
Sphincteroscopes	429
Uterine Polypus Forceps	457
Kelly-Rankin , Hemostatic Forceps	127
Keratomes	314
Kern , Bone Holding Forceps	194
Kerrison , Antrum Punch Forceps	352
Kevorkian , Biopsy Curettes	468, 469
Biopsy Punches	464
Kevorkian-Young , Biopsy Curettes	469
Key , Periosteal Raspatories	172
Keys , Dermal Punches	401
Keys Set , Dermal Punches	401
Kidney Pedicle Clamps	136
Kidney Stone Forceps	415
Kielland , Obstetrical Forceps	476
Killian , Nasal Forceps	350
Nasal Specula	346
Septum and Periosteal Elevators	353, 354
Septum Gouges	357
Septum Scissors	342
Killian-Claus , Septum Gouges	357
Kilner , Dissecting Scissors	52
Hooklets	403
Hooks for posterior nares	360
Kilner , Needle holders with T/C jaws	107

Kilner-Doughty (Russel-Davis) , Mouth Gags	370
Kirschner , Abdominal Retractors	256
Klapp , Tendon Sheath Retractors	214
Kleinert-Kutz , Bone rongeur forceps	198
Knapp , Discission Knives	314
Knapp-Clark , Eye Specula	319
Knight , Septum Forceps	350
Knives	
Cataract	314
Discission	314
Eye	314
Iris	314
Keratomes	314
Meniscotomy	180
Micro	293
Nasal	363
Plaster-of-Paris	65
Rhinoplastic	363
Swivel	362
Tonsil	375
Tympa-num	380
Knowles , Bandage Scissors	63
Kocher , Bladder Retractors	420
Hemostatic Forceps	125
Intestinal Clamp Forceps	409, 413
Ligature Conductors	92
Retractors	217, 220, 223, 226
Kocher-Langenbeck , Retractors	220
Kocher-Wagner , Retractors	237
König , Ligature Conductors	91
Koerte , Retractors	218
Kogan , Endospecula	448, 449
Krause , Nasal Polypus Snares	347
Krayenbühl , Vessel Hooks	283
Kristeller , Vaginal Specula	439, 440
Kronecker , Ligature Needles	88
Kuemmel , Abdominal and Intestinal Spatula	260
Kuhnt , Cataract Knives	314

L

Laborde , Trachea Dilators	397
Lachrymal Dilators	317
Lachrymal Probes	313
La Force , Adenotomes	365
Lahey , Gall Duct Clamps	135
Goitre Grasping Forceps	399
Retractors	222
Lambert , Chalazion Forceps	311
Lambotte , Bone Holding Forceps	195
Osteotomes	157
Periosteal Raspatories	171
Lamina Spreaders	281
Laminectomy Rongeurs	295, 296
Laminectomy Spreaders	302 – 304
Lancaster , Eye Specula	320
Lane , Bone Holding Forceps	194
Bone Levers	184
Screw Drivers	151





SCHWERT
SWORD · ESPADA
EPEE · SPADA

Alphabetical Index

Tissue Forceps	33	Love , Nerve Root Retractors	290
Towel Forceps	140	Love-Gruenwald , Intervertebral Disc Rongeurs	297
Lange-Hohmann , Bone Levers	184	Lovelace , Hemostatic Forceps	128
Lange-Hohmann modif. , Bone Levers	184	Lung Grasping Forceps	295
Langenbeck , Amputating Saws	148	Lower , Gall Duct Clamps	136
Bone Holding Forceps	192	Lowman , Bone Holding Clamps	209
Ear Curettes	378	Lowman-Baby , Bone Holding Clamps	209
Elevators	176	Lowman-Hoglund , Bone Holding Clamps	209
Periosteal Raspatories	170	Luc , Ethmoid Forceps	350
Resection Saws	148	Lucae , Ear Hooks	379
Retractors	220	Mallets	186
Larry , Rektal Directors	436	Nasal and Ear Dressing Forceps	349
Laryngeal Mirrors	10	Tuning Forks	14
Laryngoscopes	386 – 387	Lucae (Royce) , Paracentesis Needles	380
Laryngoscopes, cold light	391 – 395	Lucas , Bone Chisels	157
Laryngoscope Handles	390	Gouges	157
Laryngoscope Handles, cold light	395	Luer , Bone Rongeur Forceps	198, 200
Lateral Retraktor	446	Trachea Retractors	398
Lateral Vaginal Retractors	446	Luer-Friedmann , Bone Rongeur Forceps	200
Lateral Wire Cutters	154	Luer-Koerte , Gall Stone Scoops	418
Laufe , Haemorrhoidal Forceps	426	Lukens , Trachea Retractors	398
Lebsche , Sternum Chisels	264	Lung Grasping Forceps	34, 275
Sternum Scissors	264	Lung Spatula	274
Le Grange , Eye Scissors	49	Lupus Curettes	403
Legue , Bladder Retractors	420	Lupus Scrapers	403
Legueu , Bladder Retractors	421		
Leksell-Stille , Bone Rongeur Forceps	199	M	
Lempert , Bone Curettes	168		
Bone Rongeur Forceps	198	Maier , Polypus and Dressing Forceps	144
Leriche , Hemostatic Forceps	129	Mallets	186 – 189
Lewin , Bone Holding Forceps	190	Maltz , Nasal Rasps	359
Lexer , Gouges	160, 161	Markham-Meyerding , Retractors	247
Osteotomes	161	Markers graduated	321
Lid Retractors	321	Marquardt , Bone Rongeur Forceps	205
Ligature Conductors	90 – 92	Martel , Conductors for wire saws	279
Forceps	130, 133	Martin , Pelvimeters	475
Cutters with extra-hard inserts	114	Retractors	231
Guides	283	Uterine Sounds	453
Needles	83 – 89	Martini , Bone Curettes	166
Scissors	57	Masing , Septum and Periosteal Elevators	354
Lister , Bandage Scissors	63, 64	Masson , Needle Holders	76
Scissors with tungsten carbide edges	109	Needle Holders with T/C jaws	106
Sinus Forceps	143	Mathieu , Foreign Body Forceps	422
Supercut Scissors	61	Needle Holders	77
Lister-Burch , Eye Specula	320	Needle Holders with T/C jaws	104, 105
Lister-Excentric , Bandage Scissors	64	Mathieu , Retractors	239
Liston , Bone Cutting Forceps	206	Vaginal Specula	445
Liston-Key , Bone Cutting Forceps	206	Matson , Periosteal Raspatories	172
Liston-Mini , Bone Cutting Forceps	206	Maxi , Graspers	459
Littauer , Cilia Forceps	40	Mayfield , Bone Rongeur Forceps	205
Ligature Scissors	57	Mayo , Dissecting Scissors	44
Nasal Polypus Forceps	348	Gall Stone Probes	417
Littler , Dissecting Scissors	52	Gall Stone Scoops	419
Lobectomy Scissors	53	Scissors with tungsten carbide edges	110
Lockhart-Mummery , Probes and Directors	18	Supercut Scissors	59
Lockwood-Allis , Intestinal and Tissue Grasping Forceps	407	Mayo-Blake , Gall Stone Forceps	416
Lorenz , Bandage Scissors	63	Mayo-Guyon , Kidney Pedicle Clamps	136
Lorna , Towel Forceps	140	Mayo-Harrington , Dissecting Scissors	44



SCHWERT
SWORD · ESPADA
EPEE · SPADA

Alphabetical Index

Mayo-Hegar , Needle Holders	74
Needle Holders with T/C jaws	101
Mayo-Lexer , Dissecting Scissors	45
Scissors with tungsten carbide edges	110
Supercut Scissors	59
Mayo-Noble , Dissecting Scissors	44
Mayo-Robson , Intestinal Clamp Forceps	408, 412
Mayo-Stille , Dissecting Scissors	44
Scissors with tungsten carbide edges	110
Supercut Scissors	59
Mc Clure , Micro Scissors	322
Mc Donald , Elevators	176
Mc Givney , Haemorrhoidal Forceps	426
Mc Guire , Corneal Scissors	323
Mc Indoe , Bone Cutting Forceps	207
Cartilage Scissors	54
Dressing Forceps	26
Mc Intosh , Laryngoscopes	386, 387, 391
Laryngoscopes, cold light	392, 393
Mc Ivor , Mouth Gags	368
Mc Kenty , Septum and Periosteal Elevators	354
Mc Lean-Tucker , Obstetrical Forceps	476
Mc Pherson , Suture Forceps	308
Mead , Bone Rongeur Forceps	202
Mallets	187
Mellinger , Eye Specula	319
Mellinger-Axenfeld , Eye Specula	319
Mellinger-Beard , Eye Specula	319
Meniscotomy Knives	180
Meniscus Retractors	185
Metzenbaum , Dissecting Scissors	46
Scissors with tungsten carbide edges	111
Metzenbaum , Supercut Scissors	60
Metzenbaum, Fino , Dissecting Scissors	47
Scissors with tungsten carbide edges	111
Supercut Scissors	61
Metzenbaum-Lahey , Dissecting Scissors	47
Metzenbaum (Strabismus) , Dissecting Scissors	47
Scissors with tungsten carbide edges	110
Supercut Scissors	61
Meyer , Gouges for foreign bodies	315
Meyering , Retractors	212, 236, 247
Meyering-Scoville , Laminectomy Spreaders	303
Meyhoefer , Chalazion Curettes	318
M.G.H. , Needle Holders	74
Michel , Clip Applying Forceps	82
Micro-Friedmann , Bone Rongeur Forceps	200
Micro Corneal Scissors	322
Ear Polypus Forceps	383
Hooks	284
Knives	293
Needle Holders	80, 81
Raspatories	285
Scissors	322, 326, 327
Suture Tying Forceps	39
Middeldorpf , Retractors	224, 225
Middleton-Jansen , Septum Forceps	351
Mikulicz , Peritoneal Clamp Forceps	138

Mikulicz , Retractors	234
Miller , Laryngoscopes	388, 392, 393
Laryngoscopes, cold light	392, 393
Milligan , Retractors	243
Millin , Bladder Retractors	421
Capsule Forceps	424
Mini-Friedmann , Bone Rongeur Forceps	200
Mini-Gemini , Dissecting and Ligature Forceps	133
Mini-Hohmann , Bone Levers	181
Mini-Lambotte , Osteotomes	156
Mini-Langenbeck , Retractors	214
Mini-Lexer , Gouges	161
Mini-Lexer , Osteotomes	161
Mini-Roux , Retractors	240
Mini-Tischler , Biopsy Punches	460
Mixter , Gall Stone Forceps	416
Hemostatic Forceps	134, 135
Operating Scissors	43
Mixter-Baby , Hemostatic Forceps	134
Mixter-O'Shaugnessy , Hemostatic Forceps	134
Mod. Bonn , Iris Forceps	307
Mod. Mayo-Russ , Lung Grasping Forceps	34
Mod. Russ. , Lung Grasping Forceps	34
Mod. Tübingen , Retractors	231
Mod. USA , Umbilical Scissors	52
Mollison , Retractors	244
Molt , Mouth Gags	366
Moore , Gall Stone Scoops	419
Morse , Rib Spreaders	268, 272
Morse-Favaloro , Rib Spreaders	272
Moynihan , Clamp Forceps	137
Mueller , Eye Specula	319
Mouth Gags	366 – 370
Murdock , Eye Specula	319
Murphy-Lane , Bone Levers	184
Museux , Tenaculum Forceps	456
Myoma Screws	458

N

Nabatoff , Varicose Vein Probe Sets	20
Naegele , Obstetrical Forceps	475
Nail Instruments	479 – 482
Nippers	481
Scissors	481
Splitting Scissors	57
Nasal Cutting Forceps	336, 337, 340
Forceps	336 - 340, 348 – 350
Knives	363
Osteotomes	355 – 357
Polypus Forceps	348
Polypus Snares	347
Rasps	359
Saws	358
Scissors	56, 341
Septum Forceps	350
Specula	344 – 346
Needles Cataract	315





SCHWERT
SWORD · ESPADA
EPEE · SPADA

Alphabetical Index

Needles Foreign Body	315
Ligature	83 – 89
Paracentesis	380
Reverdin	93, 94
Needle Holders	73 – 77
Eye	78, 79
Eye, with T/C jaws	100
Micro	80 – 81
with T/C jaws	101 – 107
Neff , Menisectomy Knives	180
Negus , Hemostatic Forceps	134
Mouth Gags	369
Neivert , Hooks for posterior nares	362
Nélaton , Probes and Directors	17
Nelson , Lung Grasping Forceps	34
Root Retractors	290
News , Trachea Retractors	398
Noto , Uterine Polypus Forceps	457
Novak , Biopsy Curettes	468
Novak-Schoeckaert , Biopsy Curettes	468
Noyes , Iridectomy Scissors	324

O

Obstetrical Forceps	475, 476
Obwegeser , Periosteal raspatories	175
Ochsner-Kocher , Hemostatic Forceps	125
Oldberg , Intervertebral Disc Rongeurs	296
Olivecrona , Bone Rongeur Forceps	202
Brain Spatula	282
Dura Dissectors	288
Wire Saws	279
Ollier , Retractors	218
Olsen-Hegar , Needle Holders	75
Olsen-Hegar , Needle Holders with T/C jaws	102, 106
Ombredanne , Mallets	188
Towel Forceps	140
Operating	
Scissors	42, 43, 47, 50
Scissors, delicate	50, 52
Oscillo One-handed Saws	67 – 69
Oscillo Plaster Saws	67 – 69
Osteotomes	155 – 163
O'Sullivan-O'Connor , Abdominal Retractors	257
Ovarian Elevating Forceps	457
Overholt-Geissendoerfer , Dissecting and Ligature Forceps	130
Ovum Forceps	477

P

Paracentesis Needles	380
Parametrium , Scissors with tungsten carbide edges	109
Parker , Retractors	240
Parker-Langenbeck , Retractors	239
Park-Guyton , Eye Specula	319
Partsch , Bone Chisels	155
Gouges	155
Mallets	187

Payr , Intestinal and Stomach Clamps	410
Ligature Conductors	92
Pean , Hemostatic Forceps	124
Pederson , Vaginal Specula	442
Peers , Towel Forceps	139
Peet , Splinter Forceps	22
Pelvimeters	475
Penfield , Dura Dissectors	287
Penis Seizing Forceps	422
Pennington , Hemostatic Forceps	129
Septum and Periosteal Elevators	354
Percussion Hammers	11, 12
Percy , Amputating Retractor	149
Perineum Scissors	51
Peritoneal Clamp Forceps	138
Periosteal Elevators	354
Periosteal Raspatories	170 – 176, 379
Phaneuf , Hemostatic Forceps	136
Pierce , Septum and Periosteal Elevators	354
Piper , Obstetrical Forceps	476
Pituitary Rongeurs, cutting	296
Placenta Forceps	477
Plaster Cast Instruments	66
Saws	66 – 71
Spatula	19
Plaster-of-Paris Knives	65
Plaster-of-Paris Shears	65
Plester , Retractors	243
Politzer , Paracentesis Needles	380
Polypus and Dressing Forceps	143, 144
Polypus Forceps	143, 144, 348
Potts-Smith , Dressing Forceps	27
Forceps with T/C jaws	97
Tissue Forceps	33
Vascular Scissors	53, 54
Presbyterian , Tubing Clamps	141
Prince , Tonsil Scissors	56
Trachoma Forceps	311
Probes and Directors	17, 18, 436
Fistula	18
Gall Stone	417
Lachrymal	313
Rectal	436
Proctoscopes	428
Prostatic Retractors	423
Providence Hospital , Hemostatic Forceps	128
Punch Forceps	339
Putti , Bone Files und Rasps	179
Pylorus Spreaders	408

Q

Quervain , Elevators	176
Quire , Foreign Body Levers	384

R

Rabiner , Percussion Hammers	12
---	----



SCHWERT
SWORD · ESPADA
EPEE · SPADA

Alphabetical Index

- Ragnell-Davis**, Retractors 238
Ralk, Splinter Forceps 22
Rampley, Sponge Holding Forceps 146
Randall, Kidney Stone Forceps 415
Raney, Applying and Removing Forceps 281
Recamier, Uterine Curettes 471
Rectal Aspiration Cannulas 436
 Biopsy Specimen Forceps 434, 435
 Directors 436
 Snare 437
 Specula 429, 432, 433
Reill, Micro Scissors 326
Reiner, Plaster-of-Paris Knives 65
Reposition Forceps 192, 193
Resection Saws 148, 149
Retractors 211 – 246, 249
Reverdin, Abdominal and Intestinal Spatula 259
 Needles 93, 94
Reynolds, Dissecting Scissors 54
Rhinoplastic Knives 363
Rib Contractors 274
 Shears 262 – 264
 Spreaders 265 – 273
Ricard, Abdominal Retractors 250
Richardson, Retractors 222
Richardson-Eastman, Retractors 223
Richter, Operating Scissors 43
Rigby, Retractors 247
Roberts, Hemostatic Forceps 131
Rochester-Carmalt, Hemostatic Forceps 126
Rochester-Pean, Hemostatic Forceps 124
Roeder, Towel Forceps 139
Röttgen-Ruskin, Bone Rongeur Forceps 199
Root Retractors 290
Rose, Trachea Retractors 398
Rosen, Curettes 379
 Elevators 379
 Hooklets 379
 Periosteal Raspatories 379
Roser-König, Mouth Gags 366
Rotokürette, Biopsy Curettes 468
Roux, Retractors 240
Rubin, Nasal Osteotomes 356
 Septum Forceps 343
 Septum Forceps with T/C jaws 343
Rumel, Dissecting Forceps 131
Ruskin, Bone Cutting Forceps 208
 Bone Rongeur Forceps 198
Ruskin-Liston, Bone Cutting Forceps 208
Rust, Amputating- and Resection Saws 149
- Salenius**, Menisectomy Knives 180
Sarot, Hemostatic Forceps 131
 Needle Holders 74
 Needle Holders with T/C jaws 106
Satinsky, Blood Vessel Clamps 276
 Vascular Scissors 54
Satterlee, Amputating- and Resection Saws 148
Sauerbruch, Bone Rongeur Forceps 205
 Retractors 221, 233
Sauerbruch, Rib Shears 264
Sauerbruch-Frey, Rib Shears 264
Saws 149, 279, 358, 482
Saw Handles 279
Scalp Contour, Retractors 242
Scalpel Blades 119, 120
Scalpel Handles 116 – 118
Schädel, Towel Forceps 139
Schamberg, Comedo Extractors 404
Schede, Bone Curettes 164
Scherbak, Vaginal Specula 447
Scissors Abdominal 45
 Bandage 63, 64
 Bronchial 55
 Cartilage 54
 Cephalotomy 51
 Corneal 323, 325
 Dissecting 44 – 47, 52, 54, 55, 58
 Enterotomy 58
 Eye 49
 for obstetrics 51, 52
 Gynecological 47, 50
 Incision 43
 Iridectomy 324
 Iris 48, 49
 Iris "Ribbon type" 328
 Ligature 57
 Lobectomy 53
 Micro 322, 326, 327
 Micro Corneal 322
 Nail 481
 Nail Splitting 57
 Nasal 56, 341
 Operating 42, 43, 47, 50
 Operating, delicate 50, 52
 Perineum 51
 Secondary Cataract 322
 Septum 342
 Sternum 264
 Supercut 59 – 61
 Tenotomy 49, 323
 Tonsil 56
 Umbilical 52
 Uterine 50
 Vascular 53 – 55
 Wire Cutting 57
 with T/C edges 109 – 111
Schink, Dermatomes 402
Schlesinger, Intervertebral Disc Rongeurs 294

S

- Saalfeld**, Comedo Extractors 404
Sachs, Dissectors 289
 Skin Hooks 293
 Vessel Hooks 293
Saenger, Placenta and Ovum Forceps 477





SCHWERT
SWORD · ESPADA
EPEE · SPADA

Alphabetical Index

Schmieden , Dura Scissors	55	Singley-Tuttle , Lung Grasping Forceps	34
Ligature Conductors	91	Sinus Forceps	143
Ligature Needles	89	Sistrunk , Nail Splitting Forceps	57
Schmieden-Dick , Ligature Needles	89	Skene , Tenaculum Forceps	454
Schmieden-Payr , Ligature Conductors	91	Skin Hooks	293
Schmidt , Tonsil Seizing Forceps	373	Sluder-Ballenger , Tonsillectomes	376
Schoenborn , Thyroid Gland Retractors	398	Smillie , Meniscotomy Knives	180
Schröder , Tenaculum Forceps	455	Smith , Bandage Scissors	63
Schroeder , Uterine Curettes	474	Smith-Buie , Anal Retractors	430
Schröder-Braun , Tenaculum Forceps	454	Smith-Petersen , Bone Rongeur Forceps	204
Schubert , Biopsy Punches	465	Gouges	160
Schuhmacher , Biopsy Punches	462, 463	Osteotomes	159
Schumacher , Biopsy Punches	464	Smithwick , Nerve Hooks	292
Umbilical Scissors	52	Snellen , Entropium Forceps	312
Schwedisches Modell , Dressing Forceps	25	Specula Ear	12
Schweiger , Capsular Forceps	308	Endo	448, 449
Scoville , Laminectomy Spreaders	303	Specula Eye	319, 320
Tissue Hooks	291	Nasal	344 – 346
Scoville-Haverfield , Laminectomy Spreaders	302	Rectal	429, 432, 433
Screw Drivers	151	Vaginal	439 – 445, 447
Scull Cutting Forceps	279	Spencer , Ligature Scissors	57
Secondary Cataract Scissors	322	Spencer-Wells , Hemostatic Forceps	128
Sedillot , Periosteal Raspatories	170	Sphenoid Punches	352
Seiler , Nasal Scissors	56	Sphincteroscopes	429
Semb , Bone Cutting Forceps	208	Spinal, Bone Curettes	169
Bone Holding Forceps	191	Spinal Retractors	185
Bone Rongeur Forceps	203	Splinter Forceps	22, 37, 38
Periosteal Raspatories	173	Sponge Holding Forceps	145, 146
Semken , Dressing Forceps	26	Spratt , Bone Curettes	164, 169
Tissue Forceps	30	Spurling , Intervertebral Disc Rongeurs	297
Semm , Vaginal Specula	443	Standard , Dressing Forceps	25
Senn-Green , Retractors	238	Operating Scissors	42
Senn-Miller , Retractors	238	Scalpel Blades	119, 120
Septum Elevators	353, 354	Scalpel Handles	116, 118
Forceps	343, 350, 351	Scissors with tungsten carbide edges	109
Gouges	357	Staude-Moore , Tenaculum Forceps	455
Scissors	342	St. Clair-Thomson , Adenoid Curettes	364
Sequestum Forceps	190	St. Martin , Suture Forceps	310
Serpentine Graspers flexible IUD	459	Stellbrink , Bone Rongeur Forceps	201
Setter , Bone Holding Forceps	191	Sterilizing Forceps	146
Seutin , Plaster-of-Paris Shears	65	Sterilizing Holders	141
Sexton , Tympanum Knives	380	Sternum Chisels	264
Seyffert , Vaginal Specula	442	Sternum Scissors	264
Shapleigh , Ear Curettes	378	Stevens , Iris Forceps	307
Siebold , Uterine Scissors	50	Supercut Scissors	61
Silver , Dermatomes	402	Tenotomy Scissors	49
Nasal Osteotomes	357	Stevenson , Eye Specula	320
Simon , Bone Curettes	167	Stieglitz , Splinter Forceps	22
Retractors	231	Stille , Bone Chisels	158
Uterine Curettes	474	Bone Rongeur Forceps	199
Simpson-Braun , Obstetrical Forceps	475	Gouges	158, 159
Simpson-Luikart , Obstetrical Forceps	475	Osteotomes	158, 159
Sims , Operating Scissors	50	Plaster-of-Paris Shears	65
Rectal Specula	432, 433	Stille-Liston , Bone Cutting Forceps	206
Uterine Curettes	470	Stille-Luer , Bone Rongeur Forceps	199
Uterine Sounds	453	Stille-Ruskin , Bone Rongeur Forceps	203
Vaginal Specula	443	Stockmann , Penis Seizing Forceps	422
Sims (Bodenhammer) , Rectal Specula	432	Stomach Clamps	410





SCHWERT
SWORD · ESPADA
EPEE · SPADA

Alphabetical Index

Strabismus (Metzenbaum), Scissors with T/C jaws	110
Strabismus Forceps	310, 311
Strabismus Hooks	317
Strandell-Stille, Retractors	215
Stratte, Needle Holders	76
Needle Holders with T/C jaws	104
Strauss, Penis Seizing Forceps	422
Struempel, Ear Polypus Forceps	381
Strully, Vascular Scissors	55
Struycken, Nasal Cutting Forceps	340
Suction Tubes	436
Supercut Scissors	59 – 61
Suture Forceps	308 – 311
Tying Forceps	39, 312
Swiss Tweezers	24
Swivel Knives	362

T

Takahashi, Nasal Cutting Forceps	337
Taylor, Tissue Forceps	32, 33
Taylor, Dressing Forceps	27
Laminectomy Spreaders	303
Percussion Hammers	11
Spinal Retractors	185
TC-Rubin, Septum Forceps	343
Teale, Tenaculum Forceps	456
Temple-Fay, Abdominal Retractors	258
Tenaculum Forceps	454 – 456
Tendon Passing Instruments	177
Seizing Forceps	177
Sheath Retractors	214
Strippers	177
Tenotomy Scissors	49, 323
Thomas, Towel Forceps	141
Uterine Curettes	470
Thoms-Allis, Intestinal and Tissue Grasping Forceps	406
Thoms-Gaylor, Biopsy Punches	467
Thudichum (Goldsmith), Nasal Specula	346
Thyroid Gland Retractors	398
Tieck-Halle, Nasal Specula	344
Tischler, Biopsy Punches	460, 466
Tischler-Kevorkian, Biopsy Punches	460
Tissue Grasping Forceps	406, 407
Forceps	29 – 33
Forceps, delicate	36
Forceps with T/C jaws	97
Seizing Forceps with T/C jaws	108
Spatulas	282
Tobold, Tongue Depressors	371
Tönnis, Dissecting Scissors	54
Toennis, Dissectors	288
Micro Knives	293
Skin Hooks	293
Vessel Hooks	293
Tönnis-Adson, Scissors with tungsten carbide edges	111
Tongue Depressors	371
Tongue Holding Forceps	372

Tonsil Dissectors	375
Enucleators	375
Knives	375
Retractors	375
Scissors	56
Seizing Forceps	373
Snares	374
Tonsillectomes	376
Towel Forceps	139 – 141
Trachea Dilators	397
Retractors	397, 398
Trachoma Forceps	311
Traube, Percussion Hammers	11
Troeltsch (Wilde), Nasal and Ear Dressing Forceps	349
Troemner, Percussion Hammers	11
Trousseau, Trachea Dilators	397
Troutman, Micro Corneal Scissors	322
Tubing Clamps	141, 142
Tübinger Modell, Retractors	244
Tuffier, Abdominal and Intestinal Spatula	259
Rib Spreaders	270
Tumor Forceps	39
Tuning Forks	13 – 15
Tyding, Tonsil Snares	374
Tympanum Knives	380

U

Uckermann, Cotton Applicators	19
Ulrich, Bone Holding Forceps	197
Cotton Swab Forceps	143
Umbilical Scissors	52
Uni-Burke, Biopsy Punches	462, 463
Uni-Kevorkian, Biopsy Punches	462, 463
Uni-Oval, Biopsy Punches	462, 463
Uni-Tischler, Biopsy Punches	462, 463
Uni-Townsend, Biopsy Punches	462, 463
Universal, Wire and Pin Cutters with T/C inserts	
Universal, Wire Cutting Scissors	57
Unna, Comedo Extractors	404
Unna-Vidal, Comedo Extractors	404
USA-Modell, Dressing Forceps	26
Tissue Forceps	29, 30
Plaster Cast Instruments	66
Umbilical Scissors	52
USA-Mod. Standard, Dressing Forceps	26
Uterine Curettes	470 – 496
Depressors	453
Dilators	450 – 452
Elevating Forceps	457, 458
Hemostasis Forceps	478
Polypus Forceps	457
Scissors	50
Sounds	453

V

Vaginal Specula	447
---------------------------	-----





SCHWERT
SWORD · ESPADA
EPEE · SPADA

Alphabetical Index

Vannas , Micro Scissors	326
Secondary Cataract Scissors	322
Van Buren , Bone Holding Forceps	192
Van Doren , Biopsy Punches	467
Varicose Vein Probe Sets	20
Vascular Dilators	277
Vascular Scissors	53 – 55
Verbrugge , Bone Holding Forceps	196, 197
Verbrugge-Baby , Bone Holding Forceps	196
Vessel Hooks	283
Vidal , Lupus Scrapers	403
Vogel , Adenoid Curettes	364
Volkmann , Bone Curettes	164, 165, 168
Retractors	215 – 217

W

Wachenfeldt , Clip Applying Forceps	82
Wagener , Ear Hooks	379
Wagner , Laminectomy Rongeurs	296
Periosteal Raspatories	171
Waldmann , Perineum Scissors	51
Walter , Nasal Osteotomes	356
Walter-Carmalt , Splinter Forceps	38
Wangensteen , Forceps with T/C jaws	97
Needle Holders	76
Needle Holders with T/C jaws	103
Wassmund , Retractors	218
Watson-Cheyne , Probes and Directors	18
Waugh , Dressing Forceps	28
Tissue Forceps	32
Webster , Needle Holders	73
Needle Holders with T/C jaws	104
Weil-Blakesley , Nasal Cutting Forceps	336
Weitlaner-Baby , Retractors	242
Weitlaner-Loktite , Retractors	242
Weitlaner-Wullstein , Retractors	242
Wertheim , Clamp Forceps	137, 138
Operating and Gynecological Scissors	47
Wertheim-Cullen , Clamp Forceps	137
Wessely-Griehaber , Keratomes	314
Westcott , Tenotomy Scissors	323
Westmacott , Nasal Forceps	350
White , Tonsil Seizing Forceps	373
Whitehead , Mouth Gags	366
Wieder , Tongue Depressors	371
Wien , Nasal Specula	346
Wiener , Eye Hooks	316
Nasal Rasps	359
Wilde , Nasal Cutting Forceps	340
Wilder , Lachrymal Dilators	317
Williams , Eye Specula	319
Intestinal Grasping Forceps	407
Williger , Bone Curettes	165, 166
Elevators	176
Mallets	186
Periosteal Raspatories	171
Winter , Placenta and Ovum Forceps	477

Wire and Pin Cutters with T/C inserts	112, 113
Cutting Pliers	153, 154
Cutting Pliers with extra-hard inserts	114
Cutting Scissors	57
Saws	279
Seizing Forceps	113
Twisting Forceps with T/C jaws	113
Wittner , Biopsy Punches	464
Wolff , Lupus Curettes	403
Plaster Cast Instruments	66

Y

Yasargil , Galea Hooks	286
Ligature Guides	383
Micro Raspatories	285
Pituitary Rongeurs, cutting	296
Tumor Forceps	39
Yeoman , Rectal Biopsy Specimen Forceps	434
Yeoman (Turrell) , Rectal Biopsy Specimen Forceps	435
Young , Prostatic Retractors	423
Tongue Holding Forceps	372

Z

Zaufal , Bone Rongeur Forceps	201
Zaufal-Jansen , Bone Rongeur Forceps	203
Zenker , Dissecting and Ligature Forceps	133
Retractors	228
Ziegler , Iris Knives	134
Zweifel , Uterine Curettes	473

Index

Cat. No.	Page	Cat. No.	Page	Cat. No.	Page	Cat. No.	Page	Cat. No.	Page
10150-11	58	11104-18	17	11253-8	37	11302-14	27	11350-13	29
10150-13	58	11104-20	17	11253-9	37	11305-10	25	11350-14	29
10150-14	58	11106-13	17	11253-10	37	11305-11	25	11350-16	29
10151-11	58	11106-14	17	11253-11	37	11305-13	25	11350-20	29
10151-13	58	11106-16	17	11253-12	37	11305-14	25	11359-14	97
10151-14	58	11110-14	17	11254-8	37	11305-16	25	11359-16	97
10156-13	43	11112-16	17	11254-9	37	11305-18	25	11359-18	97
10156-14	43	11115-13	18	11254-10	37	11305-20	25	11359-20	97
10160	58	11115-18	18	11254-11	37	11305-25	25	11359-25	97
10161	58	11120-1	18	11254-12	37	11305-30	25	11361-10	29
10854-15	12	11120-2	18	11255-8	37	11306-10	25	11361-11	29
10854-20	12	11120-3	18	11255-9	37	11306-10	27	11361-13	29
10854-30	12	11120-4	18	11255-10	37	11306-11	25	11361-14	29
10854-50	12	11160-13	19	11255-11	37	11306-11	27	11361-16	29
10856-15	12	11160-14	19	11255-12	37	11306-13	25	11361-18	29
10900	11	11185	20	11260-14	22	11306-13	27	11361-20	29
10908	11	11185-1	20	11261-14	22	11306-14	25	11361-25	29
10912	11	11185-2	20	11270	22	11306-14	27	11361-30	29
10921	11	11185-3	20	11270-5	22	11306-16	25	11362-11	29
10921-1	11	11185-6	20	11272	22	11306-16	27	11362-13	29
10926	12	11185-8	20	11272-5	22	11306-18	25	11362-14	29
10930	12	11185-9	20	11275	22	11306-18	27	11362-16	29
10931	12	11185-12	20	11300-11	25	11306-20	25	11362-18	29
10935	11	11185-15	20	11300-11	27	11306-20	27	11362-20	29
10937	12	11185-20	20	11300-13	25	11306-25	25	11362-25	29
11078-11	17	11240-8	38	11300-13	27	11306-25	27	11362-30	29
11078-13	17	11240-9	38	11300-14	25	11307-13	96	11363-13	29
11078-14	17	11240-11	38	11300-14	27	11307-14	96	11363-14	29
11078-16	17	11245-8	37	11300-16	25	11307-16	96	11363-16	29
11078-18	17	11245-9	37	11300-16	27	11307-18	96	11364-13	29
11078-20	17	11245-10	37	11300-18	25	11307-20	96	11364-14	29
11079-14	17	11245-11	37	11300-18	27	11307-25	96	11364-16	29
11079-16	17	11245-12	37	11300-20	25	11307-30	96	11375-12	29
11079-18	17	11246-8	37	11300-20	27	11312-13	25	11375-13	29
11079-20	17	11246-9	37	11300-25	25	11312-13	27	11375-14	29
11080-11	17	11246-10	37	11300-25	27	11312-15	25	11375-15	29
11080-13	17	11246-11	37	11300-30	25	11312-15	27	11375-18	29
11080-14	17	11246-12	37	11300-30	27	11312-17	25	11375-21	29
11080-16	17	11247	38	11301-11	25	11312-17	27	11375-25	29
11080-18	17	11247-5	38	11301-11	27	11320-13	26	11375-31	29
11080-20	17	11248	38	11301-13	25	11320-14	26	11376-12	29
11080-25	17	11249	38	11301-13	27	11320-15	26	11376-13	29
11085-11	17	11250-8	37	11301-14	25	11325-12	26	11376-14	29
11085-13	17	11250-9	37	11301-14	27	11325-13	26	11376-15	29
11085-14	17	11250-10	37	11301-16	25	11325-14	26	11376-18	29
11085-16	17	11250-11	37	11301-16	27	11325-15	26	11376-21	29
11085-18	17	11250-12	37	11301-18	25	11325-18	26	11376-25	29
11085-20	17	11251-8	37	11301-18	27	11325-21	26	11376-31	29
11085-25	17	11251-9	37	11301-20	25	11325-25	26	11377-13	30
11090-11	17	11251-10	37	11301-20	27	11325-31	26	11377-14	30
11090-13	17	11251-11	37	11301-25	25	11326-12	26	11377-15	30
11090-14	17	11251-12	37	11301-25	27	11326-13	26	11381	31
11090-16	17	11252-8	37	11301-30	25	11326-14	26	11390-13	30
11104-11	17	11252-9	37	11301-30	27	11326-15	26	11390-15	30
11104-13	17	11252-10	37	11302-13	25	11340-13	26	11399-12	97
11104-14	17	11252-11	37	11302-13	27	11340-15	26	11399-15	97
11104-16	17	11252-12	37	11302-14	25	11342	26	11400	26



SCHWERT
SWORD - ESPADA
EPEE - SPADA





Index

SCHWERT
SWORD - ESPADA
EPEE - SPADA

<u>Cat. No.</u>	<u>Page</u>	<u>Cat. No.</u>	<u>Page</u>	<u>Cat. No.</u>	<u>Page</u>	<u>Cat. No.</u>	<u>Page</u>	<u>Cat. No.</u>	<u>Page</u>
11401-12	97	11447-20	28	11550-C20	42	11559-17	44	11580-30	46
11401-15	97	11448	32	11551-A10	42	11559-23	44	11580-411	61
11402	30	11448-1	28	11551-A11	42	11559-123	44	11580-414	60
11402-15	30	11448-5	28	11551-A13	42	11559-414	59	11580-418	60
11403	30	11448-6	32	11551-A14	42	11559-415	59	11580-B14	46
11405-12	26	11449	28	11551-A15	42	11559-417	59	11580-B18	46
11406-12	30	11449-5	28	11551-A16	42	11560-15	44	11580-B20	46
11406-15	30	11449-15	32	11551-A18	42	11560-17	44	11580-B23	46
11407-30	331	11449-18	27	11551-A20	42	11560-21	44	11580-B25	46
11407-32	331	11449-20	32	11551-B10	42	11560-415	59	11580-B28	46
11407-34	331	11449-21	27	11551-B11	42	11560-417	59	11580-B30	46
11407-305	331	11449-25	27	11551-B13	42	11561-15	44	11580-C14	46
11407-345	331	11450-18	27	11551-B14	42	11561-17	44	11580-C18	46
11407-355	331	11450-18	27	11551-B15	42	11561-21	44	11580-C20	46
11408	31	11450-20	27	11551-B16	42	11561-415	59	11580-C23	46
11410-15	34	11450-20	27	11551-B18	42	11561-417	59	11580-C25	46
11410-20	34	11450-25	27	11551-B20	42	11562-10	45	11580-C28	46
11410-25	34	11450-25	27	11551-C10	42	11562-16	45	11580-C30	46
11411	24	11452-18	33	11551-C11	42	11562-416	59	11581-11	47
11412-11	24	11452-20	33	11551-C13	42	11563-10	45	11581-14	46
11412-12	24	11452-25	33	11551-C14	42	11563-16	45	11581-18	46
11413-2	24	11452-518	33	11551-C15	42	11563-416	59	11581-20	46
11413-3	24	11452-521	33	11551-C16	42	11564-15	110	11581-23	46
11413-5	24	11452-525	33	11551-C18	42	11564-17	110	11581-25	46
11413-6	24	11454	97	11551-C20	42	11565-15	110	11581-28	46
11414-23	34	11456	97	11552-A14	109	11565-17	110	11581-30	46
11416-23	34	11463	33	11552-B14	109	11566-16	110	11581-411	61
11417-23	34	11464	33	11552-C14	109	11567-16	110	11581-414	60
11421-14	33	11474	97	11553-A14	109	11568-17	44	11581-418	60
11421-18	33	11475	97	11553-B14	109	11569-17	44	11581-B14	46
11422-14	33	11480-15	97	11553-C14	109	11576-14	43	11581-B18	46
11422-18	33	11480-23	97	11554-13	42	11576-114	43	11581-B20	46
11430-17	33	11490-10	97	11554-14	42	11577-14	43	11581-B23	46
11431-18	33	11490-15	97	11554-A13	42	11577-114	43	11581-B25	46
11434-15	30	11550-A10	42	11554-A14	42	11578-14	47	11581-B28	46
11434-20	30	11550-A11	42	11554-C13	42	11578-15	47	11581-B30	46
11434-25	30	11550-A13	42	11554-C14	42	11578-18	47	11581-C14	46
11435-15	30	11550-A14	42	11555-13	42	11578-20	47	11581-C18	46
11435-20	30	11550-A15	42	11555-14	42	11578-23	47	11581-C20	46
11435-25	30	11550-A16	42	11555-A13	42	11578-114	47	11581-C23	46
11439	27	11550-A18	42	11555-A14	42	11578-414	61	11581-C25	46
11439-5	27	11550-A20	42	11555-C13	42	11578-415	61	11581-C28	46
11440	27	11550-B10	42	11555-C14	42	11579-14	47	11581-C30	46
11440-5	27	11550-B11	42	11556-14	110	11579-15	47	11582-11	110
11441-18	97	11550-B13	42	11556-17	110	11579-18	47	11582-14	111
11441-20	97	11550-B14	42	11557-14	110	11579-20	47	11582-18	111
11441-25	97	11550-B15	42	11557-17	110	11579-23	47	11582-20	111
11442	32	11550-B16	42	11558-14	44	11579-114	47	11582-23	111
11442-5	32	11550-B18	42	11558-15	44	11579-414	61	11583-11	110
11444	27	11550-B20	42	11558-17	44	11579-415	61	11583-14	111
11444-5	27	11550-C10	42	11558-23	44	11580-11	47	11583-18	111
11446	31	11550-C11	42	11558-123	44	11580-14	46	11583-20	111
11446-1	31	11550-C13	42	11558-414	59	11580-18	46	11583-23	111
11446-5	31	11550-C14	42	11558-415	59	11580-20	46	11584-14	111
11447	32	11550-C15	42	11558-417	59	11580-23	46	11584-18	111
11447-5	32	11550-C16	42	11559-14	44	11580-25	46	11584-20	111
11447-15	28	11550-C18	42	11559-15	44	11580-28	46	11584-23	111

Index

<u>Cat. No.</u>	<u>Page</u>	<u>Cat. No.</u>	<u>Page</u>	<u>Cat. No.</u>	<u>Page</u>	<u>Cat. No.</u>	<u>Page</u>	<u>Cat. No.</u>	<u>Page</u>
11585-14	111	11611-32	48	11675-18	63	12155-2	84	12435-20	75
11585-18	111	11611-33	48	11675-20	63	12157-1	84	12435-23	75
11585-20	111	11611-411	61	11675-414	61	12157-2	84	12436-15	103
11585-23	111	11612	111	11675-418	61	12160-1	85	12436-18	103
11587	111	11613	111	11675-420	61	12160-2	85	12436-20	103
11590-15	43	11615	57	11676-16	64	12162-1	85	12436-23	103
11590-115	43	11616	57	11677-18	109	12162-2	85	12436-26	103
11591-14	47	11616-11	57	11691-20	63	12164-1	86	12437-1	73
11591-15	43	11616-12	57	11691-22	63	12164-2	86	12437-2	73
11591-19	47	11623-1	52	11694	64	12165-1	86	12438	103
11591-22	47	11623-2	52	11695	64	12165-2	86	12439	104
11591-115	43	11624-1	50	11699-23	65	12166-1	87	12439-1	104
11592	47	11624-2	50	11720	64	12166-2	87	12439-5	104
11593	47	11624-5	50	11720-15	64	12167-1	87	12440	77
11595-12	52	11624-6	50	11722-23	64	12167-2	87	12446-18	74
11595-13	52	11625	74	11808	65	12180-1	88	12446-26	74
11595-15	52	11626-11	107	11809	65	12180-2	88	12447-17	74
11596-12	52	11626-16	107	11812	65	12350-14	100	12448-14	74
11596-16	54	11628-11	75	11837	66	12351-14	100	12450-14	74
11597-2	43	11628-14	75	11865-24	65	12352-14	100	12450-16	74
11598-1	49	11628-16	75	11866-23	65	12353-14	100	12450-18	74
11598-2	49	11628-18	75	11866-26	65	12356-14	100	12450-20	74
11598-21	49	11628-111	75	11866-37	65	12356-18	100	12450-24	74
11598-22	49	11628-114	75	11867-26	65	12356-21	100	12450-26	74
11598-401	61	11628-116	75	11867-37	65	12357-14	100	12450-116	74
11598-421	61	11629-14	102	11882	66	12357-18	100	12450-118	74
11599-1	49	11629-16	102	11884	66	12357-21	100	12450-120	74
11599-2	49	11629-17	102	11885	66	12358-14	100	12451-16	74
11599-21	49	11629-18	102	11895	66	12358-18	100	12451-18	74
11599-22	49	11630-14	106	11895-18	66	12358-21	100	12451-20	74
11602	57	11630-17	106	12041	82	12359-14	100	12451-24	74
11603	57	11631-11	107	12044	82	12359-18	100	12451-26	74
11604-10	49	11631-21	107	12047	82	12359-21	100	12452-14	101
11605-10	49	11640-1	43	12048	82	12360-10	332	12452-16	101
11608-9	48	11640-5	43	12050	82	12360-16	332	12452-18	101
11608-10	48	11641-30	53	12059	82	12360-60	332	12452-20	101
11608-11	48	11642-19	54	12100-1	93	12360-61	333	12452-23	101
11609-9	48	11644-19	54	12100-2	93	12360-66	332	12452-26	101
11609-10	48	11646-18	54	12100-3	93	12360-67	333	12452-30	101
11609-11	48	11647-18	54	12100-4	93	12360-70	333	12453-20	102
11609-21	48	11648-17	55	12104-1	93	12365-14	100	12453-24	102
11609-22	48	11649-17	55	12104-2	93	12370-16	100	12455-20	104
11609-23	48	11651-20	55	12104-3	93	12371-16	100	12455-26	104
11609-31	48	11652-11	55	12104-4	93	12374-13	100	12459	113
11609-32	48	11653-17	55	12105-1	94	12375-13	100	12460	76
11609-33	48	11654-14	55	12105-2	94	12400-15	77	12461-21	76
11610-9	48	11656-18	63	12105-3	94	12423	107	12461-26	76
11610-10	48	11656-20	63	12105-4	94	12424-13	73	12462-23	76
11610-11	48	11658-17	57	12140	89	12424-18	73	12464	76
11610-411	61	11658-23	63	12141	89	12427	73	12464-1	76
11611-9	48	11660-13	57	12142	89	12428	73	12465	103
11611-10	48	11660-14	63	12148	89	12430	73	12471-27	76
11611-11	48	11661-13	57	12150-1	83	12431	101	12472-20	103
11611-21	48	11662-15	57	12150-2	83	12432	73	12472-26	103
11611-22	48	11675-9	63	12152-1	83	12434	73	12473-23	104
11611-23	48	11675-11	63	12152-2	83	12435-15	75	12484-20	107
11611-31	48	11675-14	63	12155-1	84	12435-18	75	12484-23	107



SCHWERT
SWORD - ESPADA
EPEE - SPADA





Index

SCHWERT
SWORD - ESPADA
EPEE - SPADA

<u>Cat. No.</u>	<u>Page</u>	<u>Cat. No.</u>	<u>Page</u>	<u>Cat. No.</u>	<u>Page</u>	<u>Cat. No.</u>	<u>Page</u>	<u>Cat. No.</u>	<u>Page</u>
12484-26	107	13066-10	119	13390-20	124	13563	128	13703-16	130
12488-13	101	13066-11	119	13390-22	124	13563-16	128	13703-17	130
12488-15	101	13066-12	119	13390-24	124	13564	127	13703-21	130
12488-16	101	13066-13	119	13390-26	124	13565	127	13703-22	130
12488-18	101	13066-14	119	13390-30	124	13568	127	13703-23	130
12488-20	101	13066-15	119	13391-13	124	13569	127	13703-24	130
12488-23	101	13066-16	119	13391-14	124	13580	127	13703-25	130
12488-26	101	13066-17	119	13391-16	124	13581	127	13703-26	130
12494-18	103	13067-18	120	13391-18	124	13584	127	13703-27	130
12494-20	103	13067-19	120	13391-20	124	13585	127	13705-1	131
12494-23	103	13067-20	120	13391-22	124	13590-15	129	13705-2	131
12494-26	103	13067-21	120	13391-24	124	13591-15	129	13705-3	131
12506-14	77	13067-22	120	13391-26	124	13600	123	13705-4	131
12506-17	77	13067-23	120	13391-30	124	13600-14	123	13706	131
12506-20	77	13067-24	120	13392-14	124	13601	123	13706-5	131
12506-114	77	13067-25	120	13393-14	124	13601-14	123	13707-24	131
12506-117	77	13067-34	120	13430-13	125	13602	123	13707-42	133
12506-120	77	13070	330	13430-14	125	13602-14	123	13707-43	133
12506-217	77	13197	149	13430-16	125	13603	123	13709-18	135
12506-220	77	13214	148	13430-18	125	13603-14	123	13709-24	135
12506-A14	77	13218-27	148	13430-20	125	13606	123	13709-27	135
12506-A17	77	13218-30	148	13430-22	125	13607	123	13710-15	134
12507-17	77	13218-115	148	13430-24	125	13608	123	13710-19	134
12507-20	77	13218-120	148	13430-26	125	13609	123	13711	134
12507-117	77	13222	148	13430-30	125	13618	128	13714-20	132
12507-120	77	13222-1	148	13431-13	125	13619	128	13714-26	132
12508-14	104	13232	149	13431-14	125	13660-18	123	13714-520	132
12508-17	104	13232-6	149	13431-16	125	13660-20	123	13714-526	132
12508-20	104	13232-8	149	13431-18	125	13661-18	123	13715-15	134
12509-14	105	13232-15	149	13431-20	125	13661-20	123	13715-19	134
12509-17	105	13232-18	149	13431-22	125	13662-18	123	13715-20	132
12509-20	105	13238-12	148	13431-24	125	13662-20	123	13715-26	132
12510-17	105	13238-15	148	13431-26	125	13663-18	123	13715-520	132
12510-20	105	13238-18	148	13431-30	125	13663-20	123	13715-526	132
12511-17	105	13238-35	148	13432-14	125	13670	129	13717-18	133
12511-20	105	13242	149	13433-14	125	13671	129	13717-22	133
12511-27	106	13242-5	149	13440-16	126	13678-14	134	13717-25	133
12514-14	105	13242-6	149	13440-20	126	13678-18	134	13717-28	133
12514-17	105	13242-8	149	13441-16	126	13679-14	129	13718-13	133
12514-20	105	13260-30	279	13441-20	126	13679-18	129	13718-14	133
12520-18	106	13260-40	279	13511	128	13682	130	13718-16	133
12520-20	106	13260-50	279	13520-13	128	13683	130	13718-18	133
12520-26	106	13260-60	279	13520-14	128	13685	130	13718-20	133
13051	116	13260-70	279	13520-15	128	13688	128	13718-23	133
13051	330	13265-30	279	13520-18	128	13689	373	13718-25	133
13053	117	13265-40	279	13520-20	128	13690	373	13718-28	133
13053-L	117	13265-50	279	13520-24	128	13691	373	13724-22	135
13053-LA	117	13266-50	279	13521-13	128	13692	373	13724-25	135
13054	117	13271	279	13521-14	128	13697-1	134	13724-28	135
13054-L	117	13284	279	13521-15	128	13697-2	134	13727-19	135
13054-LA	117	13284-30	279	13521-18	128	13700	131	13727-23	135
13057	118	13352-14	124	13521-20	128	13701	131	13729	136
13057-K	118	13352-16	124	13521-24	128	13703-11	130	13735-13	406
13058	118	13390-13	124	13560	127	13703-12	130	13735-14	406
13059	118	13390-14	124	13561	127	13703-13	130	13736-15	406
13060	330	13390-16	124	13562	128	13703-14	130	13738-15	406
13061	330	13390-18	124	13562-16	128	13703-15	130	13738-19	406



Index

Cat. No.	Page	Cat. No.	Page	Cat. No.	Page	Cat. No.	Page	Cat. No.	Page
13738-23	406	13985	139	14640-B12	155	14662-20	158	14679-32	163
13738-25	406	13996	141	14640-B14	155	14662-25	158	14680-6	163
13739-15	407	13998	141	14640-B16	155	14662-30	158	14680-13	163
13739-20	407	14123-1	152	14641-3	155	14663-10	158	14680-19	163
13739-22	407	14123-2	152	14641-4	155	14663-15	158	14680-25	163
13739-25	407	14124	152	14641-5	155	14663-20	158	14680-32	163
13741-16	406	14125	152	14641-6	155	14663-25	158	14684-3	156
13743-15	406	14126-2	153	14641-8	155	14665-6	159	14684-4	156
13743-19	406	14126-5	153	14641-10	155	14665-8	159	14684-6	156
13744-15	406	14126-7	153	14641-12	155	14665-10	159	14684-8	156
13744-16	108	14127-2	113	14641-14	155	14665-12	159	14684-10	156
13744-19	108	14127-3	113	14641-16	155	14665-15	159	14684-12	156
13745-15	406	14127-6	113	14652-2	155	14665-20	159	14684-15	156
13746-20	406	14128	153	14652-3	155	14665-25	159	14685-3	156
13747-16	407	14130	152	14652-4	155	14665-30	159	14685-4	156
13747-20	407	14136-12	112	14652-5	155	14666-4	158	14685-6	156
13772	129	14138	114	14652-6	155	14666-6	158	14685-8	156
13772-20	129	14139	114	14652-7	155	14666-8	158	14685-10	156
13840	122	14140	114	14652-8	155	14666-10	158	14685-12	156
13840-5	122	14145	57	14653-2	155	14666-12	158	14685-15	156
13841	122	14146	112	14653-3	155	14666-15	158	14688-8	157
13841-5	122	14152	153	14653-4	155	14667-6	158	14688-10	157
13864	122	14157-16	112	14653-5	155	14667-8	158	14688-13	157
13865	122	14157-18	112	14653-6	155	14667-10	158	14688-15	157
13866-3	122	14157-22	112	14653-7	155	14667-12	158	14688-20	157
13866-5	122	14160-15	153	14653-8	155	14667-15	158	14688-25	157
13867-3	122	14161	113	14654-2	155	14668-4	156	14688-30	157
13867-5	122	14161-23	154	14654-3	155	14668-6	156	14688-38	157
13941	139	14162-21	154	14654-4	155	14668-8	156	14689-8	157
13941-5	139	14164-1	154	14654-5	155	14668-10	156	14689-10	157
13943	139	14164-45	154	14654-6	155	14668-12	156	14689-13	157
13957-9	139	14164-56	154	14654-7	155	14668-14	156	14689-15	157
13957-11	139	14165-16	113	14654-8	155	14669-4	156	14689-20	157
13957-13	139	14178	150	14655-2	155	14669-6	156	14689-25	157
13957-15	139	14325-25	151	14655-3	155	14669-8	156	14689-30	157
13961-13	139	14325-35	151	14655-4	155	14669-10	156	14689-38	157
13961-15	139	14331	151	14655-5	155	14669-12	156	14698-4	161
13962	140	14332	151	14655-6	155	14669-14	156	14698-6	161
13964-14	139	14360-12	209	14655-7	155	14676-6	162	14698-8	161
13965-10	140	14360-18	209	14655-8	155	14676-13	162	14698-10	161
13965-13	140	14360-20	209	14658-4	157	14676-19	162	14698-12	161
13966-13	140	14360-22	209	14658-6	157	14676-25	162	14699-4	161
13967-11	140	14365-13	209	14659-3	157	14676-32	162	14699-6	161
13967-13	140	14365-18	209	14659-5	157	14677-6	162	14699-8	161
13968-11	140	14640-A3	155	14660-6	159	14677-13	162	14699-10	161
13968-13	140	14640-A4	155	14660-8	159	14677-19	162	14699-12	161
13969-10	141	14640-A5	155	14660-10	159	14677-25	162	14700-5	161
13969-13	141	14640-A6	155	14660-12	159	14677-32	162	14700-7	161
13970-16	142	14640-A8	155	14660-15	159	14678-6	163	14700-10	161
13970-18	142	14640-A10	155	14660-20	159	14678-13	163	14700-15	161
13970-20	142	14640-A12	155	14660-25	159	14678-19	163	14700-20	161
13971-16	142	14640-A14	155	14660-30	159	14678-25	163	14700-25	161
13971-18	142	14640-A16	155	14662-6	158	14678-32	163	14700-30	161
13971-20	142	14640-B4	155	14662-8	158	14679-6	163	14701-5	161
13975-16	141	14640-B6	155	14662-10	158	14679-13	163	14701-7	161
13978-16	141	14640-B8	155	14662-12	158	14679-19	163	14701-10	161
13978-20	140	14640-B10	155	14662-15	158	14679-25	163	14701-15	161



SCHWERT
SWORD - ESPADA
EPEE - SPADA





Index

SCHWERT
SWORD - ESPADA
EPEE - SPADA

Cat. No.	Page	Cat. No.	Page	Cat. No.	Page	Cat. No.	Page	Cat. No.	Page
14701-20	161	14744-50	188	14775-1	167	14795-30	164	14877-5	173
14701-25	161	14745	189	14775-10	167	14795-40	164	14878	173
14701-30	161	14746-1	189	14775-20	167	14796-1	164	14879	173
14702-10	160	14746-2	189	14775-30	167	14796-2	164	14880-1	174
14703-10	160	14751-1	169	14776-1	167	14796-3	164	14880-2	174
14704-6	159	14751-2	169	14776-10	167	14796-4	164	14880-3	174
14704-9	159	14751-3	169	14776-20	167	14796-10	164	14881-1	174
14704-13	159	14751-4	169	14776-30	167	14796-20	164	14881-2	174
14704-16	159	14751-5	169	14778-13	165	14796-30	164	14881-3	174
14704-19	159	14751-6	169	14778-14	165	14798-10	168	14882	175
14704-25	159	14751-10	169	14778-17	165	14798-20	168	14883	175
14704-32	159	14751-20	169	14780-13	165	14798-30	168	14884	175
14705-6	159	14751-30	169	14780-16	165	14798-40	168	14920	176
14705-9	159	14752-1	169	14780-20	165	14798-50	168	14921	176
14705-13	159	14752-2	169	14785-0	168	14799-1	168	14922	176
14705-16	159	14752-3	169	14785-1	168	14799-2	168	14923	176
14705-19	159	14752-4	169	14785-2	168	14799-3	168	14924	176
14705-25	159	14752-5	169	14785-3	168	14800	171	14925	176
14705-32	159	14752-6	169	14785-4	168	14801	171	14935-1	178
14706-6	160	14752-10	169	14786-1	165	14802-1	175	14935-2	178
14706-9	160	14752-20	169	14786-2	165	14802-2	175	14935-3	178
14706-13	160	14752-30	169	14786-10	165	14802-3	175	14936-1	178
14706-16	160	14753-1	169	14786-20	165	14802-4	175	14936-2	178
14706-19	160	14753-2	169	14791-1	165	14804-1	175	14936-3	178
14706-25	160	14753-3	169	14791-2	165	14804-2	175	14937	179
14706-32	160	14753-4	169	14791-3	165	14804-3	175	14938	179
14707-6	160	14753-5	169	14791-4	165	14804-4	175	14939	179
14707-9	160	14753-6	169	14791-5	165	14808	353	14944	178
14707-13	160	14753-10	169	14791-6	165	14820-1	172	14945	178
14707-16	160	14753-20	169	14791-10	165	14820-2	172	14955-3	181
14707-19	160	14753-30	169	14791-20	165	14821-1	172	14955-5	181
14707-25	160	14754-1	169	14791-30	165	14821-2	172	14955-7	181
14707-32	160	14754-2	169	14793-1	164	14832	170	14960-8	182
14710-3	162	14754-3	169	14793-2	164	14833	170	14960-10	182
14710-5	162	14754-4	169	14793-3	164	14840	170	14960-17	182
14710-6	162	14754-5	169	14793-4	164	14843	170	14960-18	182
14710-8	162	14754-6	169	14793-5	164	14854	170	14960-22	183
14710-9	162	14754-10	169	14793-10	164	14856-1	170	14960-24	183
14720	186	14754-20	169	14793-20	164	14856-2	170	14960-34	183
14721	186	14754-30	169	14793-30	164	14865-10	171	14960-42	182
14722	186	14760-1	166	14794-1	164	14865-15	171	14960-43	183
14723	186	14760-10	166	14794-2	164	14865-20	171	14960-65	183
14728	187	14760-20	166	14794-3	164	14865-25	171	14961-6	181
14728-1	187	14762-1	166	14794-4	164	14867-6	171	14961-8	181
14730	186	14762-10	166	14794-5	164	14867-8	171	14962	181
14732-25	186	14762-20	166	14794-6	164	14869-8	171	14962-22	184
14732-30	186	14767	166	14794-10	164	14869-17	171	14963	182
14732-35	186	14770-1	167	14794-20	164	14873	172	14963-30	184
14733	187	14770-2	167	14794-30	164	14874	172	14963-33	184
14736	187	14770-3	167	14795-1	164	14875-6	172	14964-45	184
14736-5	187	14770-4	167	14795-2	164	14875-12	172	14964-65	184
14737	187	14770-5	167	14795-3	164	14875-19	172	14966	184
14737-5	187	14770-6	167	14795-4	164	14875-25	172	14967	184
14740	187	14774-1	167	14795-5	164	14877-1	173	14975	185
14741	188	14774-2	167	14795-6	164	14877-2	173	14976	185
14742	188	14774-10	167	14795-10	164	14877-3	173	14977	185
14743	188	14774-20	167	14795-20	164	14877-4	173	14978-7	185

Index

Cat. No.	Page	Cat. No.	Page	Cat. No.	Page	Cat. No.	Page	Cat. No.	Page
14978-10	185	15063	214	15124-A	217	15325-3	224	15460-5	236
14985-1	177	15063	214	15124-B	217	15331-1	223	15460-7	236
14985-2	177	15065-4	238	15126-A	217	15331-2	223	15460-9	236
14985-3	177	15066-A	238	15126-B	217	15331-3	223	15462-1	237
14985-4	177	15066-B	238	15131-30	218	15331-10	223	15462-2	237
14985-5	177	15068	238	15131-60	218	15331-11	223	15462-3	237
14986	177	15069	238	15132	218	15367-1	222	15462-4	237
14987-15	177	15075-10	214	15180	218	15367-2	222	15620-1	225
14987-19	177	15075-10	214	15181	218	15367-3	222	15620-1A	225
14987-24	177	15075-17	214	15204	219	15367-4	222	15620-2	225
14988	177	15075-17	214	15205	219	15367-15	222	15620-3	225
15031	211	15075-20	214	15206	219	15371-1	223	15622-1	225
15031-B	211	15075-20	214	15206-70	219	15371-2	223	15622-2	225
15032	211	15075-22	214	15270	239	15371-S	223	15622-3	225
15032-B	211	15075-22	214	15275-A	239	15387-1	221	15629	226
15033	211	15076-1	238	15275-B	239	15387-2	221	15629	226
15033-B	211	15076-2	238	15277	240	15387-3	221	15630	226
15034	211	15079-2A	215	15277-1	240	15389	222	15630	226
15034-B	211	15079-2B	215	15277-2	240	15396-1	232	15632	226
15038-1A	211	15079-3A	215	15277-3	240	15396-2	232	15632	226
15038-1B	211	15079-3B	215	15278	240	15396-2	232	15633-1	226
15038-2A	211	15079-4A	215	15279	240	15396-2	232	15633-1	226
15038-2B	211	15079-4B	215	15284	239	15396-3	232	15633-2	226
15038-3A	211	15079-6A	215	15291	239	15396-3	232	15633-2	226
15038-3B	211	15079-6B	215	15292-1	240	15397	233	15633-3	226
15038-4A	211	15081-A	216	15292-2	240	15399-1	233	15633-3	226
15038-4B	211	15081-B	216	15300-55	220	15399-2	233	15635-1	227
15040-1A	212	15082-A	216	15300-60	220	15401	231	15635-2	227
15040-1B	212	15082-B	216	15300-63	220	15401-1	234	15635-3	227
15040-2A	212	15083-A	216	15310-1	221	15401-2	234	15635-4	227
15040-2B	212	15083-B	216	15310-2	221	15401-3	234	15635-5	227
15040-3A	212	15084-A	216	15310-3	221	15402	231	15635-6	227
15040-3B	212	15084-B	216	15310-4	221	15403-8	234	15636-1	228
15040-4A	212	15086-A	216	15314-1	220	15403-10	234	15636-2	228
15040-4B	212	15086-B	216	15314-2	220	15403-12	234	15636-3	228
15042-1	212	15091-A	216	15314-3	220	15403-13	234	15636-4	228
15042-2	212	15091-B	216	15314-4	220	15403-14	234	15672-1	238
15042-3	212	15092-A	216	15314-5	220	15403-16	234	15672-2	238
15042-4	212	15092-B	216	15315-1	220	15403-18	234	15704-50	241
15042-5	212	15093-A	216	15315-2	220	15404-8	235	15704-70	241
15042-6	212	15093-B	216	15315-3	220	15404-10	235	15704-A50	241
15045-8	213	15094-A	216	15315-4	220	15404-12	235	15704-A70	241
15045-10	213	15094-B	216	15315-5	220	15404-14	235	15705-7	320
15045-12	213	15096-A	216	15317-0	220	15404-16	235	15705-10	320
15045-14	213	15096-B	216	15317-1	220	15404-18	235	15706-7	320
15045-16	213	15101-A	217	15317-2	220	15415-1	229	15706-10	320
15045-18	213	15101-B	217	15317-3	220	15415-2	229	15707-A	241
15046-8	213	15102-A	217	15317-4	220	15416	229	15707-B	241
15046-10	213	15120	215	15317-5	220	15418-1	230	15709-15	244
15046-12	213	15121	215	15317-20	220	15418-2	230	15710-16	244
15046-14	213	15121-A	217	15317-30	220	15418-3	230	15711-A16	244
15046-16	213	15121-B	217	15317-50	220	15419-1	229	15711-B16	244
15046-18	213	15122	215	15323-1	224	15419-2	229	15712-10	242
15048	214	15122-A	217	15323-2	224	15419-3	229	15712-13	242
15048	214	15122-B	217	15323-3	224	15441-1	230	15712-16	242
15062	214	15123-A	217	15325-1	224	15441-2	230	15712-20	242
15062	214	15123-B	217	15325-2	224	15445	274	15712-A10	242



SCHWERT
SWORD - ESPADA
EPEE - SPADA





Index

SCHWERT
SWORD - ESPADA
EPEE - SPADA

<u>Cat. No.</u>	<u>Page</u>	<u>Cat. No.</u>	<u>Page</u>	<u>Cat. No.</u>	<u>Page</u>	<u>Cat. No.</u>	<u>Page</u>	<u>Cat. No.</u>	<u>Page</u>
15712-A13	242	15741-A26	246	15823-2	256	16085-17	194	16230-23	199
15712-A16	242	15741-B26	246	15823-3	256	16085-21	194	16235-2	204
15712-A20	242	15745-28	250	15823-4	256	16088-33	194	16235-3	204
15714	242	15745-30	250	15823-10	256	16088-45	194	16235-4	204
15714-A	242	15746	250	15864	482	16089-33	194	16236-4	199
15715-A20	249	15747-8	251	15864-1	482	16089-45	194	16236-8	199
15716	242	15747-16	250	15865	482	16090-17	196	16239	199
15717-A	242	15752	251	15865-1	482	16090-25	196	16242	199
15717-B	242	15753	251	15880	482	16090-26	196	16243	199
15718	248	15753-2	251	15915-1	180	16090-27	196	16246	199
15718-9	248	15755-18	251	15915-2	180	16091-15	197	16247	199
15718-11	248	15755-27	251	15915-3	180	16091-19	197	16250	203
15718-13	248	15755-38	251	15917-1	180	16091-24	197	16251	203
15719-B	243	15755-38	255	15917-2	180	16091-26	197	16255-1	204
15720-A	243	15755-40	251	15918	180	16091-28	197	16255-2	204
15720-B	243	15755-45	255	15919-1	180	16092-23	197	16255-3	204
15721-1	243	15760	248	15919-2	180	16092-25	197	16256-1	204
15721-2	243	15761-10	248	15920-1	180	16092-28	197	16256-2	204
15722-13	244	15761-14	248	15920-2	180	16093-28	197	16256-3	204
15722-16	244	15765-1	252	16024	190	16097	190	16258	205
15722-20	244	15770-1	252	16025	190	16098-13	192	16259	205
15722-26	244	15770-3	252	16027	190	16098-20	193	16263	205
15722-A13	244	15771	252	16031	192	16099-21	193	16264	205
15722-A16	244	15773	258	16040	192	16106	200	16326-14	206
15722-A20	244	15774	258	16048	192	16107	200	16326-17	206
15722-A26	244	15779	253	16049	190	16108	200	16326-19	206
15725-31	245	15779	253	16054	191	16110-1	198	16326-22	206
15725-B31	245	15781	253	16055	191	16110-2	198	16329-14	206
15726	245	15781	253	16056-16	191	16110-3	198	16329-17	206
15726-A	245	15781-11	254	16056-24	191	16115	202	16329-19	206
15727-1A	249	15782	254	16060	191	16116	202	16329-22	206
15727-1B	249	15783	253	16061	191	16118-14	200	16334	206
15727-4A	249	15783	253	16063	193	16118-17	200	16335	206
15727-4B	249	15783-11	254	16064-17	190	16132-30	201	16337-15	207
15728-1	247	15785	254	16068-23	192	16132-45	201	16337-17	207
15728-2	247	15785-11	254	16068-26	192	16132-90	201	16360	207
15728-11	247	15800	256	16069	192	16139	202	16361	207
15728-12	247	15800-1	256	16077-22	195	16140	198	16362	207
15728-13	247	15800-2	255	16077-22	195	16141	198	16364	208
15728-14	247	15800-2	256	16077-27	195	16154	201	16365	208
15729-32	249	15800-3	255	16077-27	195	16155	201	16366	208
15730-25	304	15800-3	256	16077-30	195	16162	200	16367	208
15730-75	304	15800-4	256	16077-30	195	16163	200	16369	207
15730-A40	304	15800-5	256	16080-22	195	16182	203	16375	208
15730-A45	304	15800-6	256	16080-22	195	16183	202	16378	206
15730-A50	304	15800-7	256	16080-26	195	16185-1	201	16379	206
15730-A55	304	15800-10	256	16080-26	195	16185-2	201	16380	206
15730-A60	304	15805	255	16080-33	195	16186	201	16382	206
15730-B40	304	15805-8	255	16080-33	195	16187	202	16430	262
15730-B45	304	15805-R	255	16081-23	195	16220	203	16430	262
15730-B50	304	15815	257	16081-23	195	16221	203	16432-23	262
15730-B55	304	15815-1	257	16081-26	195	16222	203	16432-23	262
15730-B60	304	15815-2	257	16081-26	195	16223	198	16434-22	262
15740-A20	245	15815-10	257	16084-15	193	16226	203	16434-22	262
15740-A26	246	15818	247	16084-17	194	16229	198	16457-26	264
15740-B20	245	15823	256	16084-21	194	16229-23	199	16470-1	263
15740-B26	246	15823-1	256	16085-15	193	16230	198	16479-1	263



Index

Cat. No.	Page	Cat. No.	Page	Cat. No.	Page	Cat. No.	Page	Cat. No.	Page
16480	264	17104-25	277	18142-5	303	18197-25	301	18225-22	297
16484-25	263	17104-30	277	18142-7	303	18197-102	301	18225-23	297
16490	264	17104-35	277	18142-8	303	18197-103	301	18225-24	297
16498	264	17104-40	277	18142-15	303	18197-104	301	18225-102	295
16549	274	17104-45	277	18142-17	303	18197-105	301	18225-103	295
16550	274	17104-50	277	18142-18	303	18197-106	301	18225-104	295
16553	274	17104-70	277	18143-1	303	18201-1	294	18225-112	295
16560	265	17104-90	277	18143-2	303	18201-2	294	18225-113	295
16561	265	17228-15	35	18143-3	303	18201-3	294	18225-114	295
16562-1	265	17228-20	35	18143-4	303	18202-2	294	18225-122	295
16562-2	265	17228-24	35	18144-1	303	18202-3	294	18225-123	295
16562-3	265	17228-30	35	18144-2	303	18202-4	294	18225-124	295
16563	266	17246-15	35	18144-3	303	18204	296	18225-202	295
16564-1	266	17246-20	35	18144-4	303	18205	296	18225-203	295
16564-2	266	17246-24	35	18147-1	303	18206	296	18225-204	295
16564-3	266	17246-30	35	18147-2	303	18210-1	299	18225-212	295
16565-1	267	17248-15	35	18147-3	303	18210-2	299	18225-213	295
16565-2	267	17248-20	35	18173	279	18210-3	299	18225-214	295
16565-3	267	17248-24	35	18178	279	18210-4	299	18225-222	295
16565-4	267	17248-30	35	18195-2	300	18210-5	299	18226-2	297
16566-1	268	17249-15	35	18195-3	300	18210-6	299	18226-3	297
16566-2	268	17249-20	35	18195-4	300	18210-11	299	18226-4	297
16566-3	268	17249-24	35	18195-5	300	18210-12	299	18226-12	297
16567	268	17249-30	35	18195-6	300	18210-13	299	18226-13	297
16574-16	270	17250-15	35	18195-6	300	18210-14	299	18226-14	297
16576-1	271	17250-20	35	18196-2	300	18210-15	299	18226-22	297
16576-2	271	17250-24	35	18196-3	300	18210-16	299	18226-23	297
16577-1	272	17250-30	35	18196-4	300	18210-21	299	18226-24	297
16577-2	272	17277	53	18196-5	300	18210-22	299	18226-26	300
16578	272	17278	53	18196-22	301	18210-23	299	18227-2	297
16579	273	17279	53	18196-23	301	18210-24	299	18227-3	297
16584	269	17279-1	53	18196-24	301	18210-25	299	18227-4	297
16586	270	17283-24	54	18196-25	301	18210-26	299	18227-12	297
16590-1	269	17447-1	276	18196-26	301	18210-201	299	18227-13	297
16590-2	269	17447-2	276	18196-26	301	18210-202	299	18227-14	297
16590-3	269	17449-1	276	18196-52	300	18210-203	299	18227-22	297
16594-25	270	17449-2	276	18196-53	300	18210-204	299	18227-23	297
16825	275	17450-15	277	18196-54	300	18210-205	299	18227-24	297
16826	275	17463-1	277	18196-55	300	18210-206	299	18231-16	281
16829-3	275	17463-2	277	18196-102	301	18210-211	299	18232-16	281
16830-1	275	17463-3	277	18196-103	301	18210-212	299	18232-25	281
16830-3	275	17517-2	122	18196-104	301	18210-213	299	18350-1	287
16831-20	108	17517-4	122	18196-105	301	18210-214	299	18350-2	287
16837-3	275	17517-6	122	18196-106	301	18210-215	299	18350-3	287
16844-16	407	17526-6	122	18196-202	301	18210-216	299	18350-4	287
16844-18	407	17526-7	122	18196-202	301	18210-221	299	18350-5	287
16844-20	407	17526-9	122	18196-203	301	18210-222	299	18351-1	288
16844-23	407	17526-10	122	18196-203	301	18210-223	299	18351-2	288
16845-16	108	17527-5	122	18196-204	301	18210-224	299	18352-18	288
16845-20	108	17527-6	122	18196-204	301	18210-225	299	18352-24	288
16846-16	407	17527-8	122	18196-205	301	18210-226	299	18353-18	288
16846-21	407	17527-10	122	18196-205	301	18225-2	297	18353-24	288
16848-20	407	18114	280	18196-206	301	18225-3	297	18354-1	289
17104-05	277	18116	280	18196-206	301	18225-4	297	18354-2	289
17104-10	277	18117	280	18197-22	301	18225-12	297	18356	289
17104-15	277	18140-1	302	18197-23	301	18225-13	297	18357-45	289
17104-20	277	18141-1	302	18197-24	301	18225-14	297	18357-90	289



SCHWERT
SWORD · ESPADA
EPEE · SPADA





Index

SCHWERT
SWORD - ESPADA
EPEE - SPADA

<u>Cat. No.</u>	<u>Page</u>	<u>Cat. No.</u>	<u>Page</u>	<u>Cat. No.</u>	<u>Page</u>	<u>Cat. No.</u>	<u>Page</u>	<u>Cat. No.</u>	<u>Page</u>
18366	290	18625-5	39	19073-2	321	19491-5	318	19680	309
18367	290	18626-3	39	19073-3	321	19491-6	318	19682	309
18368	290	18626-5	39	19073-4	321	19491-7	318	19692-5	309
18373-1	291	18674-12	327	19119	319	19491-8	318	19692-10	309
18373-2	291	18674-15	327	19120	319	19493-1	318	19693-5	309
18374	291	18674-18	327	19121	319	19493-2	318	19693-10	309
18380-7	282	18675-12	327	19122	319	19493-3	318	19694	309
18380-11	282	18675-15	327	19125-1	319	19502-1	317	19695	309
18380-15	282	18675-17	334	19125-2	319	19502-2	317	19701	310
18380-18	282	18675-18	327	19126	319	19502-3	317	19703-5	310
18384-8	282	18675-117	334	19127	319	19600	36	19703-10	310
18384-11	282	18675-217	334	19128	319	19602	36	19704-5	310
18384-14	282	18712-13	80	19136	320	19603	36	19704-10	310
18384-17	282	18712-14	80	19139	319	19604	36	19705-5	310
18384-20	282	18712-18	80	19140	319	19605	36	19705-9	310
18386-7	282	18713-13	80	19141	319	19606	36	19710	310
18386-11	282	18713-14	80	19142	319	19610	306	19711	310
18386-15	282	18713-18	80	19143	320	19612	306	19712	310
18386-18	282	18714-13	81	19145	320	19613	306	19728	306
18387-7	282	18714-14	81	19146	320	19614	306	19740	312
18387-11	282	18714-18	81	19150	320	19615	306	19742	40
18387-15	282	18715-13	81	19220-0	314	19616	306	19742-9	40
18387-18	282	18715-14	81	19220-1	314	19618-1	307	19744	40
18392	290	18715-18	81	19220-2	314	19618-2	307	19745	312
18404	289	18834-1	283	19220-3	314	19618-3	307	19746-1	40
18430-1	293	18834-2	283	19222-1	314	19619-1	307	19746-2	40
18430-2	293	18834-3	283	19222-2	314	19619-2	307	19747	312
18432	293	18834-4	283	19222-3	314	19619-3	307	19750	312
18435	293	18835-1	283	19224-1	314	19620-1	307	19763-1	312
18436	293	18835-2	283	19224-2	314	19620-2	307	19763-2	312
18440-13	293	18835-3	283	19260-1	314	19620-3	307	19774-20	311
18440-18	293	18835-4	283	19260-2	314	19621-1	307	19774-25	311
18442	403	18837	284	19260-3	314	19621-2	307	19774-30	311
18444-1	403	18838	284	19312-1	314	19621-3	307	19776	311
18444-2	403	18852-1	285	19312-2	314	19623	306	19777	311
18448	293	18852-2	285	19312-3	314	19626	307	19786	311
18451-1	292	18852-3	285	19336	315	19627	307	19790-1	311
18456-1	292	18852-4	285	19337	315	19630	306	19791	311
18456-2	292	18852-5	285	19360	315	19631	306	19792	311
18457-1	292	18852-11	285	19361	315	19632	306	19820-1	323
18457-2	292	19045-1	313	19365	315	19640	307	19820-2	323
18459	292	19045-2	313	19390	316	19641	307	19821-1	323
18460-17	292	19045-3	313	19391	316	19642	307	19821-2	323
18460-21	292	19045-4	313	19394	316	19643	307	19822	323
18485	293	19045-5	313	19395	316	19644	307	19823	324
18486-13	293	19045-6	313	19396-1	316	19645	307	19824	323
18486-19	293	19045-7	313	19396-2	316	19664	308	19825	49
18558	281	19045-10	313	19397-1	316	19665	308	19826	49
18566-31	286	19045-20	313	19397-2	316	19666	308	19827-1	324
18566-41	286	19045-30	313	19420-1	317	19670	308	19827-2	324
18608-15	39	19054-1	315	19420-2	317	19672-1	308	19827-3	324
18608-18	39	19054-2	315	19420-3	317	19672-2	308	19830-1	325
18609-15	39	19056-3	316	19491-0	318	19673-1	308	19830-2	325
18609-18	39	19065-15	321	19491-1	318	19673-2	308	19831	322
18624-3	39	19065-20	321	19491-2	318	19674-1	308	19832	322
18624-5	39	19072	321	19491-3	318	19674-2	308	19833	322
18625-3	39	19073-1	321	19491-4	318	19678	309	19834-10	322

Index

Cat. No.	Page	Cat. No.	Page	Cat. No.	Page	Cat. No.	Page	Cat. No.	Page
19834-11	322	20154-C4	13	20380-3	381	20529	378	21168-4	352
19835-1	322	20154-C5	13	20380-4	381	20681-1	352	21198-D	340
19835-2	322	20155-C1	13	20380-6	381	20681-2	352	21198-D1,5	340
19836-1	322	20158-C1	13	20380-7	381	20681-3	352	21198-L1	337
19836-2	322	20158-C64	13	20380-20	381	20748-1	346	21198-L2	337
19838-1	325	20158-C128	13	20380-22	381	20748-2	346	21198-L11	337
19838-2	325	20160-C	14	20380-25	381	20748-3	346	21198-L12	337
19842	325	20160-C1	14	20380-30	381	20748-4	346	21198-V1	336
19852-1	324	20160-C2	14	20380-35	381	20748-5	346	21198-V2	336
19852-2	324	20160-C3	14	20381-1	382	20748-6	346	21198-V3	336
19852-3	324	20160-C4	14	20381-2	382	20748-7	346	21198-V4	336
19853	324	20160-C5	14	20381-3	382	20769-1	344	21198-V5	336
19860-1	326	20161-C	14	20381-4	382	20769-2	344	21198-V11	336
19860-2	326	20175-1	15	20382-1	383	20769-3	344	21198-V12	336
19860-3	326	20178	15	20382-2	383	20779-1	344	21198-V13	336
19861-1	326	20202-12	19	20382-3	383	20779-2	344	21198-V14	336
19861-2	326	20202-14	19	20382-4	383	20779-3	344	21198-V15	336
19862-1	326	20203-14	19	20382-5	383	20782-1	344	21198-V21	336
19862-2	326	20204-14	19	20382-6	383	20785-1	346	21198-V22	336
19883	323	20204-16	19	20382-7	383	20785-2	346	21198-V23	336
19883-1	323	20204-18	19	20382-8	383	20785-3	346	21198-V24	336
19890-9	328	20208-18	19	20440	241	20790-1	346	21199-L1	337
19890-10	328	20209-18	19	20441	241	20790-2	346	21199-L2	337
19891-9	328	20210-16	19	20505	378	20790-3	346	21199-L11	337
19891-10	328	20220-18	19	20506-1	378	20790-4	346	21199-L12	337
19892-9	328	20230-1	379	20506-2	378	20791-1	345	21199-V1	336
19893-9	328	20230-2	379	20506-3	378	20791-2	345	21199-V2	336
19914	79	20230-3	379	20506-4	378	20791-3	345	21199-V11	336
19920-1	79	20234-2	379	20508-0	377	20791-4	345	21199-V12	336
19920-2	79	20234-3	379	20508-1	377	20791-11	345	21201-3	340
19950-14	78	20234-4	379	20508-2	377	20791-12	345	21201-4	340
19950-18	78	20234-5	379	20508-3	377	20930	347	21201-13	340
19950-21	78	20234-6	379	20508-4	377	20937	374	21201-14	340
19950-114	78	20234-7	379	20508-20	377	20937-90	374	21202-3	340
19951-14	78	20236-1	379	20508-30	377	20950	349	21202-4	340
19951-18	78	20236-2	379	20509-0	377	20950-18	349	21202-13	340
19951-21	78	20236-3	379	20509-1	377	20952	349	21202-14	340
19951-114	78	20236-4	379	20509-2	377	20955	349	21205-1	338
19952-14	78	20236-5	379	20509-3	377	20957	349	21205-11	338
19953-14	78	20252-1	378	20509-4	377	21026-20	143	21205-21	338
19960-13	79	20252-2	378	20509-20	377	21027-20	143	21206-1	339
19960-18	79	20252-3	378	20509-30	377	21039-13	348	21206-11	339
19961-13	79	20286	380	20510-0	377	21039-16	348	21206-21	339
19961-18	79	20286-5	380	20510-1	377	21039-20	348	21236-18	56
20123-3	12	20290	380	20510-2	377	21040	348	21238-17	56
20123-11	12	20290-5	380	20510-3	377	21041	348	21244	56
20123-12	12	20296-1	380	20510-4	377	21052	350	21255-20	342
20123-13	12	20296-2	380	20510-20	377	21086	350	21256-20	342
20123-14	12	20296-3	380	20510-30	377	21090	350	21258-1	341
20124	12	20326	349	20511-0	377	21100	350	21258-2	341
20124	12	20327	349	20511-1	377	21115-3	350	21258-3	341
20124	12	20328	349	20511-2	377	21115-4	350	21264	343
20124-3	12	20331	349	20511-3	377	21143	351	21264-TC	343
20154-C	13	20331-11	349	20511-4	377	21144	351	21268	343
20154-C1	13	20375	384	20511-20	377	21168-1	352	21292-1	363
20154-C2	13	20377	384	20511-30	377	21168-2	352	21292-3	363
20154-C3	13	20380-2	381	20521	378	21168-3	352	21301	363



SCHWERT
SWORD - ESPADA
EPEE - SPADA





Index

SCHWERT
SWORD - ESPADA
EPEE - SPADA

<u>Cat. No.</u>	<u>Page</u>	<u>Cat. No.</u>	<u>Page</u>	<u>Cat. No.</u>	<u>Page</u>	<u>Cat. No.</u>	<u>Page</u>	<u>Cat. No.</u>	<u>Page</u>
21302	363	21427	171	21570-1	365	21894-19	372	23211-L1	387
21303	363	21429	354	21570-2	365	21897	372	23211-L1	388
21304	363	21430	354	21570-3	365	21897-5	372	23211-L1	389
21317-0	362	21435	353	21571-1	365	21911	372	23211-L2	387
21317-1	362	21436-19	353	21571-2	365	22020	374	23211-L2	388
21317-2	362	21436-22	353	21571-3	365	22024	374	23211-L2	389
21319-0	362	21437	354	21644	366	22025	374	23212	386
21319-1	362	21465	353	21655	366	22031	374	23218-0	389
21319-2	362	21487-10	358	21656	366	22061	376	23218-1	389
21340-2	357	21487-11	358	21666	366	22062	376	23218-2	389
21344	357	21487-12	358	21670	366	22063	376	23218-3	389
21345	357	21493	359	21685-11	366	22120	375	23218-4	389
21358-4	357	21494-1	359	21685-13	366	22126	375	23225	388
21362-4	357	21494-2	359	21694-9	366	22127	375	23225-0	388
21370-4	355	21496	359	21694-11	366	22128	375	23225-1	388
21370-7	355	21499	359	21694-13	366	22129	375	23225-2	388
21370-9	355	21501-1	359	21694-15	366	22203	56	23225-3	388
21370-12	355	21501-2	359	21716-GL	367	22204	56	23225-4	388
21371-6	355	21515-1	360	21716-GL	369	22213	56	23225-15	392
21372-4	355	21515-2	360	21717-GL	367	22218	56	23229	390
21372-7	355	21515-3	360	21717-GL	369	22388-18	373	23230	387
21372-9	355	21516	360	21719-1	367	22443	373	23230	388
21372-12	355	21518	360	21720-2	367	22500	10	23230	390
21374-4	356	21519	360	21720-3	367	22505-0	10	23251-0	391
21374-5	356	21520-2	361	21720-4	367	22505-1	10	23251-1	391
21374-6	356	21520-5	361	21720-5	367	22505-2	10	23251-2	391
21374-7	356	21520-7	361	21720-GL	367	22505-3	10	23251-3	391
21375-6	355	21520-10	361	21720-GL	369	22505-4	10	23251-4	391
21376-16	355	21522	361	21720-L	367	22505-5	10	23251-13	391
21377-16	355	21523-1	361	21720-SI	367	22505-6	10	23258-0	394
21378-10	356	21523-2	361	21720-SI	369	22505-7	10	23258-1	394
21378-12	356	21523-3	361	21735	368	22505-8	10	23258-2	394
21378-14	356	21524	361	21735-1	368	22505-9	10	23258-3	394
21381-10	356	21525	360	21735-2	368	22505-10	10	23258-4	394
21381-12	356	21532-19	360	21735-3	368	22505-20	10	23265-0	393
21381-14	356	21533	360	21735-G	368	22505-30	10	23265-1	393
21381-16	356	21534	360	21737-1	369	22508-0	10	23265-2	393
21383-1	357	21535	360	21737-2	369	22508-1	10	23265-3	393
21383-2	357	21536	361	21737-3	369	22508-2	10	23265-4	393
21383-3	357	21537	362	21741	370	22508-3	10	23265-15	392
21384-3	356	21538	362	21741-1	370	22508-4	10	23265-15	392
21384-4	356	21539	362	21741-2	370	22508-5	10	23269	395
21385-3	356	21540	362	21741-3	370	22508-6	10	23270	395
21385-4	356	21541	364	21741-4	370	22508-7	10	23275-1	395
21385-7	356	21544-1	364	21741-5	370	22508-8	10	23275-3	395
21385-9	356	21544-2	364	21741-G	370	22508-9	10	23587	397
21385-12	356	21544-3	364	21750-14	371	22508-10	10	23588	397
21397-4	354	21544-4	364	21750-18	371	22508-20	10	23590	398
21397-5	354	21544-5	364	21751	371	22508-30	10	23593	398
21402	353	21546-1	364	21760	371	23211	386	23594	398
21405	176	21546-2	364	21770-12	371	23211-0	387	23595	398
21406	354	21546-3	364	21770-16	371	23211-1	387	23596	398
21421-1	353	21546-4	364	21775-1	371	23211-2	387	23606-L	397
21421-2	353	21557-1	364	21775-2	371	23211-3	387	23606-R	397
21422	354	21557-2	364	21777	371	23211-4	387	23610	397
21423	354	21557-3	364	21795	371	23211-13	386	23611	397
21425	354	21557-4	364	21894-17	372	23211-13	391	23614	398

Index

Cat. No.	Page	Cat. No.	Page	Cat. No.	Page	Cat. No.	Page	Cat. No.	Page
23615	398	24420	260	24601-23	408	25007	136	25562	428
23705-1	90	24421-20	260	24601-25	408	25037-22	137	25563	428
23705-2	90	24421-20	260	24602	412	25050-1	415	25579-16	427
23705-3	90	24421-30	260	24603	412	25050-2	415	25579-19	427
23705-4	90	24421-30	260	24717-5	409	25050-3	415	25579-22	427
23711-15	92	24421-40	260	24717-7	409	25050-4	415	25585	427
23711-17	92	24421-40	260	24717-10	409	25050-5	415	25590	430
23714	91	24425-30	260	24718-8	410	25050-6	415	25775-2	441
23715	91	24425-30	260	24718-23	410	25178	419	25775-3	441
23720-1	91	24425-40	260	24719	410	25200	422	25776-0	441
23720-2	91	24425-40	260	24725	410	25201	422	25776-1	441
23720-3	91	24425-50	260	24725-1	410	25210-16	422	25776-2	441
23751	399	24425-50	260	24727	410	25210-21	422	25776-3	441
23751-20	399	24425-60	260	24727-1	410	25210-26	422	25791-1	442
23813	403	24425-60	260	24731	410	25210-32	422	25791-2	442
23818	404	24425-70	260	24731-1	410	25235-20	422	25791-3	442
23820	404	24425-70	260	24735	410	25301	423	25798-1	441
23820-10	404	24472	92	24735-1	410	25302	423	25798-2	441
23821	404	24473	92	24818	417	25303	423	25798-3	441
23822	404	24474	92	24832-1	417	25304	423	25799-1	442
23824	404	24510	408	24832-2	417	25315	424	25799-2	442
23826-3	403	24564-13	411	24832-3	417	25317	424	25799-3	442
23826-4	403	24564-16	411	24832-4	417	25319	424	25802-1	442
23826-5	403	24564-18	411	24832-5	417	25320	424	25802-2	442
23826-6	403	24564-21	411	24832-6	417	25335	421	25803-1	443
23827-1	403	24564-23	411	24832-7	417	25335-1	421	25803-2	443
23827-2	403	24565-13	411	24832-8	417	25335-5	421	25803-3	443
23827-3	403	24565-16	411	24832-9	417	25335-8	421	25825	447
23827-4	403	24565-18	411	24832-10	417	25335-12	421	25826	447
23827-5	403	24565-21	411	24832-11	417	25339	421	25832	447
23827-6	403	24565-23	411	24832-12	417	25342	421	25832-1	447
23830-2	401	24568-17	408	24832-13	417	25348	420	25832-2	447
23830-3	401	24568-21	408	24838-1	417	25355	420	25832-3	447
23830-4	401	24568-23	408	24838-2	417	25356	420	25832-4	447
23830-5	401	24569-17	408	24838-3	417	25467	426	25832-5	447
23830-6	401	24569-21	408	24850-1	419	25469	426	25832-10	447
23830-7	401	24569-23	408	24850-2	419	25470	426	25832-14	447
23830-8	401	24584-22	409	24850-3	419	25517	432	25832-18	447
23831	401	24584-25	409	24850-4	419	25520-1	433	25835-1	448
23840	402	24584-28	409	24852	419	25520-2	433	25835-2	448
23841	402	24585-22	409	24865	419	25520-3	433	25835-3	448
23842	402	24585-25	409	24869-1	418	25520-4	433	25836-3	449
23846	402	24585-28	409	24869-2	418	25524	432	25837-3	449
24405-30	259	24586-22	413	24869-3	418	25525	432	25855-1	443
24405-40	259	24586-25	413	24869-4	418	25538	431	25855-2	443
24405-50	259	24586-28	413	24869-5	418	25538-1	431	25855-3	443
24407-6	259	24587-22	413	24869-10	418	25538-2	431	25878-1	439
24407-9	259	24587-25	413	24869-20	418	25538-3	431	25878-2	439
24407-12	259	24587-28	413	24869-30	418	25538-4	431	25878-3	439
24407-17	259	24590	126	24879-1	416	25540	429	25878-5	440
24407-20	259	24590-15	126	24879-2	416	25542	430	25878-6	440
24407-25	259	24591	126	24884	416	25555	429	25878-7	440
24409-28	259	24591-15	126	24885	416	25556	429	25878-10	440
24409-30	259	24600-21	408	24886	416	25559-1	428	25878-11	440
24414	259	24600-23	408	24887	416	25559-2	428	25880-1	439
24417	259	24600-25	408	24889	416	25561	428	25880-2	439
24420	260	24601-21	408	24905	136	25561-0	428	25880-3	439



SCHWERT
SWORD - ESPADA
EPEE - SPADA





Index

SCHWERT
SWORD - ESPADA
EPEE - SPADA

Cat. No.	Page	Cat. No.	Page	Cat. No.	Page	Cat. No.	Page	Cat. No.	Page
25880-5	440	25973-3,5	450	25980-13	452	26283	454	26844	458
25880-6	440	25973-4	450	25980-15	452	26284	455	26875-1	474
25880-7	440	25973-4,5	450	25980-17	452	26285	455	26875-2	474
25880-10	440	25973-5	450	25980-19	452	26315	455	26875-3	474
25880-11	440	25973-5,5	450	25980-21	452	26316	455	26875-4	474
25884-0	439	25973-6	450	25980-23	452	26321	454	26875-5	474
25884-1	439	25973-6,5	450	25980-25	452	26325	454	26875-6	474
25884-2	439	25973-7	450	25980-PL8	452	26333	456	26876-1	474
25884-3	439	25973-7,5	450	25980-PL13	452	26348	456	26876-2	474
25884-5	440	25973-8	450	25980-S8	452	26349	456	26876-3	474
25884-6	440	25973-8,5	450	25984-6	452	26350	456	26876-4	474
25884-7	440	25973-9	450	25984-9	452	26364-6	456	26876-5	474
25884-10	440	25973-9,5	450	25984-11	452	26364-8	456	26876-6	474
25884-11	440	25973-10	450	25984-13	452	26364-10	456	26924-1	470
25888-1	443	25973-10,5	450	25984-15	452	26365-6	456	26924-2	470
25888-2	443	25973-11	450	25984-17	452	26365-8	456	26924-3	470
25888-11	443	25973-11,5	450	25984-19	452	26365-10	456	26924-4	470
25888-12	443	25973-12	450	26010	453	26420	458	26924-5	470
25888-A	443	25973-12,5	450	26010-1	453	26448	457	26924-6	470
25888-B	443	25973-13	450	26014	453	26468	478	26934-A1	470
25890-12	445	25973-13,5	450	26035	453	26566	136	26934-A2	470
25891-2	445	25973-14	450	26140-13	143	26567	136	26934-A3	470
25892-1A	445	25973-14,5	450	26140-16	143	26632	137	26934-A4	470
25892-1B	445	25973-15	450	26140-18	143	26632-22	138	26934-A5	470
25892-1C	445	25973-15,5	450	26144-22	143	26634	137	26934-A6	470
25892-1D	445	25973-16	450	26144-25	143	26634-5	137	26934-B1	470
25892-2A	445	25973-16,5	450	26145-22	143	26635-19	137	26934-B2	470
25892-2B	445	25973-17	450	26145-25	143	26635-21	137	26934-B3	470
25892-2C	445	25973-17,5	450	26156	144	26637-19	137	26934-B4	470
25892-2D	445	25973-18	450	26156-22	144	26637-21	137	26934-B5	470
25892-3A	445	25973-18,5	450	26157	144	26637-23	137	26934-B6	470
25892-3B	445	25973-19	450	26157-22	144	26641-1	137	26935-A1	470
25892-3C	445	25973-19,5	450	26166	144	26661-1	138	26935-A2	470
25892-3D	445	25973-20	450	26167	144	26661-2	138	26935-A3	470
25915-1	444	25973-20,5	450	26190	145	26675-1	138	26935-A4	470
25915-2	444	25973-21	450	26194	145	26675-2	138	26935-A5	470
25915-3	444	25973-21,5	450	26200	146	26720-A20	50	26935-A6	470
25915-4	444	25973-22	450	26201	146	26720-A23	50	26935-B1	470
25915-5	444	25973-22,5	450	26225	457	26720-B20	50	26935-B2	470
25915-11	444	25973-23	450	26232	145	26720-B23	50	26935-B3	470
25915-12	444	25973-23,5	450	26232-18	145	26725-A20	50	26935-B4	470
25915-13	444	25973-24	450	26232-20	145	26725-A23	50	26935-B5	470
25915-14	444	25973-25	450	26233	145	26725-B20	50	26935-B6	470
25915-15	444	25973-26	450	26233-18	145	26725-B23	50	26954-A00	471
25915-16	444	25973-27	450	26233-20	145	26729	50	26954-A0	471
25920	446	25973-28	450	26234	145	26730-1	109	26954-A1	471
25920	446	25973-29	450	26234-18	145	26730-2	109	26954-A2	471
25921	446	25973-30	450	26234-20	145	26778	45	26954-A3	471
25921	446	25973-L14	451	26235	145	26778-16	45	26954-A4	471
25928	444	25973-PL14	450	26235-18	145	26779	45	26954-A5	471
25935-1	231	25973-PL26	450	26235-20	145	26779-16	45	26954-A6	471
25935-2	231	25980-1	452	26237	457	26786	51	26954-A7	471
25973-1	450	25980-3	452	26240-25	145	26787	51	26954-A8	471
25973-1,5	450	25980-5	452	26241-25	145	26791-14	51	26954-A9	471
25973-2	450	25980-7	452	26257	144	26791-22	51	26954-A10	471
25973-2,5	450	25980-9	452	26280	454	26793	51	26954-A11	471
25973-3	450	25980-11	452	26282	454	26842	458	26954-A12	471



Index

<u>Cat. No.</u>	<u>Page</u>	<u>Cat. No.</u>	<u>Page</u>	<u>Cat. No.</u>	<u>Page</u>	<u>Cat. No.</u>	<u>Page</u>	<u>Cat. No.</u>	<u>Page</u>
26954-A13	471	26955-B16	471	27133-10	463	28351-20	146		
26954-A14	471	26961-A0	472	27135-24	467	28351-24	146		
26954-A15	471	26961-A1	472	27153	467	28360-20	146		
26954-A16	471	26961-A2	472	27153-1	467	29475	480		
26954-B00	471	26961-A3	472	27158-21	465	29476	480		
26954-B0	471	26961-A4	472	27158-29	465	29487-9	481		
26954-B1	471	26961-A5	472	27159	465	29487-10	481		
26954-B2	471	26961-A6	472	27161	466	29488-9	481		
26954-B3	471	26961-B0	472	27165	466	29490	480		
26954-B4	471	26961-B1	472	27166	467	29491	480		
26954-B5	471	26961-B2	472	27176-11	435	29492	480		
26954-B6	471	26961-B3	472	27176-12	435	29493	481		
26954-B7	471	26961-B4	472	27176-21	435	29495	481		
26954-B8	471	26961-B5	472	27176-22	435	29497	481		
26954-B9	471	26961-B6	472	27180-128	434	29498	481		
26954-B10	471	26970	473	27180-135	434	29820-44	70		
26954-B11	471	27116	468	27180-142	434	29820-50	70		
26954-B12	471	27116-1	468	27180-228	434	29820-65	70		
26954-B13	471	27116-2	468	27180-235	434	29820-165	70		
26954-B14	471	27116-3	468	27180-242	434	29820-170	70		
26954-B15	471	27120	468	27182-1	464	29820-265	70		
26954-B16	471	27121	468	27182-2	464	29821-44	70		
26955-A00	471	27122-1	469	27190-1	464	29821-50	70		
26955-A0	471	27122-2	469	27190-2	464	29821-65	70		
26955-A1	471	27122-3	469	27194	464	29821-165	70		
26955-A2	471	27123	469	27195	464	29821-170	70		
26955-A3	471	27125	459	27220-1	436	29821-265	70		
26955-A4	471	27126	459	27220-2	436	29822-50	70		
26955-A5	471	27128-1	460	27224-15	436	29822-65	70		
26955-A6	471	27128-2	460	27230	437	29825-1	71		
26955-A7	471	27128-3	460	27230-03	437	29825-2	71		
26955-A8	471	27128-4	460	27238-28	437	29825-3	71		
26955-A9	471	27128-5	460	27520	475	29825-4	71		
26955-A10	471	27128-6	460	27524	475	29826-17	71		
26955-A11	471	27129-1	461	27610-36	475	29827-230	71		
26955-A12	471	27129-2	461	27610-39	475	29828	71		
26955-A13	471	27130-1	462	27626-30	475	29831	67		
26955-A14	471	27130-2	462	27626-33	475	29850	68		
26955-A15	471	27130-3	462	27626-36	475	29855	68		
26955-A16	471	27130-4	462	27635	475	29860	69		
26955-B00	471	27130-5	462	27641	476				
26955-B0	471	27130-6	462	27642	476				
26955-B1	471	27130-7	462	27643	476				
26955-B2	471	27130-8	462	27644	476				
26955-B3	471	27130-9	462	27756	52				
26955-B4	471	27130-10	462	27758	52				
26955-B5	471	27131	463	27761-13	52				
26955-B6	471	27132	463	27761-16	52				
26955-B7	471	27133-1	463	27880	477				
26955-B8	471	27133-2	463	27881	477				
26955-B9	471	27133-3	463	27888-1	477				
26955-B10	471	27133-4	463	27888-2	477				
26955-B11	471	27133-5	463	27888-3	477				
26955-B12	471	27133-6	463	27889-1	477				
26955-B13	471	27133-7	463	27889-2	477				
26955-B14	471	27133-8	463	27889-3	477				
26955-B15	471	27133-9	463	28351-16	146				



SCHWERT
SWORD · ESPADA
EPEE · SPADA





SCHWERT
SWORD · ESPADA
EPEE · SPADA

Wichtige Hinweise Important notice Indications importantes Avisos importantes

Wichtige Hinweise

- SCHWERT ist ein international eingetragenes Warenzeichen der Firma A. Schweickhardt GmbH & Co. KG. SCHWERT-Instrumente entsprechen der DIN EN ISO 13485.
- Dieser Katalog wendet sich nur an ausgebildetes Fachpersonal. Er bleibt unser Eigentum. Sein Gebrauch bleibt auf Ein- und Verkauf von SCHWERT-Instrumenten beschränkt. Weiterverwendung, Nachdruck und Vervielfältigung, auch auszugsweise und insbesondere einzelner abgebildeter Instrumente sind nicht gestattet ohne vorherige ausdrückliche schriftliche Genehmigung der Firma A. Schweickhardt GmbH & Co. KG. Katalogkonzeption und -gestaltung sowie Illustrationen und Designelemente unterliegen dem urheberrechtlichen Schutz. Verletzungen werden verfolgt und können sowohl zivil- als auch strafrechtliche Konsequenzen haben. Technische Änderungen ohne Ankündigung vorbehalten.
- Als sichere Sterilisiermethode empfehlen wir ausschließlich Dampfsterilisation, jede andere Methode wendet der Arzt auf eigene Verantwortung an. Bei Heißluftsterilisation darauf achten, dass 180°C nicht überschritten werden, da sonst mit nicht mehr entfernbaren Verfärbungen und Härteabfall der Instrumente gerechnet werden muss.
- Für die Desinfektion, Reinigung und Sterilisation der Instrumente beachten Sie bitte die Hinweise in der aktuellen Broschüre „Instrumenten-Aufbereitung richtig gemacht“. (www.a-k-i.org)

Indications importantes

- SCHWERT est une marque déposée internationale de A. Schweickhardt GmbH & Co. KG. Les instruments EPEE correspondent au standard DIN EN ISO 13485.
- Ce catalogue s'adresse seulement au personnel qualifié. Le catalogue reste notre propriété. Son emploi est limité à l'achat et la vente d'instruments EPEE. Le copyright, aussi de la création et réalisation du catalogue et des illustrations et éléments créatifs, est réservé à nous. Il est défendu de le reproduire ou copier, même en abrégé et instruments individuels sans permission écrite précédente de A. Schweickhardt GmbH & Co. KG. Toute violation sera poursuivie devant les tribunaux. Des modifications d'instruments peuvent être faites sans avis.
- Comme méthode de stérilisation fiable, nous recommandons seulement autoclave. Toute autre méthode est appliquée à la seule responsabilité du docteur. En cas de stérilisation à l'air chaud la température ne doit pas passer 180°C, parce que une température plus haute peut provoquer un changement de couleur et même une réduction de dureté de l'instrument.
- Pour la désinfection, nettoyage et stérilisation des instruments, veuillez considérer les indications dans la brochure actuelle « Le traitement correct des instruments de chirurgie. » (www.a-k-i.org)

Important notice

- SCHWERT is an internationally registered trade mark of A. Schweickhardt GmbH & Co. KG. SCHWERT-instruments comply with the DIN EN ISO 13485 standard.
- This catalogue is only addressed to trained specialists. It remains our property. Its use is limited to buying and selling SCHWERT instruments. Copyright is reserved to us, reprints and duplications, also of parts and especially of single instruments are strictly forbidden without previous written authorization of A. Schweickhardt GmbH & Co. KG. Design and layout of the catalogue, illustrations and design elements are also subject to our copyright. Violations will be prosecuted. Instruments may be subject to design changes without notice.
- As safe sterilisation method we recommend only autoclaving, every other method is applied exclusively at the doctor's responsibility. If hot air sterilisation is used, make sure that temperature does not exceed 180°C, because a higher temperature can lead to non-removable discolorations and a loss in hardness of the instruments.
- For disinfection, cleaning and sterilization of the instruments please pay attention to the references in the current brochure "Proper maintenance of instruments". (www.a-k-i.org)

Avisos importantes

- SCHWERT es una marca registrada y protegida internacionalmente de A. Schweickhardt GmbH & Co. KG. Los instrumentos ESPADA son conformes a la Norma DIN EN ISO 13485.
- Este catálogo se dirige únicamente a personal profesional especializado. El catálogo es de nuestra propiedad. Su uso está limitado a la compra y venta de instrumentos ESPADA. Su reproducción total o parcial, en particular instrumentos individuales, está prohibida sin el previo permiso escrito de A. Schweickhardt GmbH & Co. Todos los derechos de autor tanto para la creación y presentación como para las ilustraciones y elementos creativos son de nuestra propiedad. Cualquier violación de estos derechos será perseguida judicialmente. Los instrumentos pueden sufrir posibles modificaciones técnicas sin previo aviso.
- Como método seguro de esterilización únicamente recomendamos el autoclave, cualquier otro método aplicado será bajo la responsabilidad del doctor. En caso de esterilización con aire caliente, la temperatura no debe exceder de 180°, porque una temperatura más alta puede provocar decoloraciones y una reducción de la dureza del instrumento.
- Para la desinfección, limpieza y esterilización de los instrumentos por favor preste atención al apartado "El método correcto para el tratamiento de instrumentos." en el folleto actual. (www.a-k-i.org)



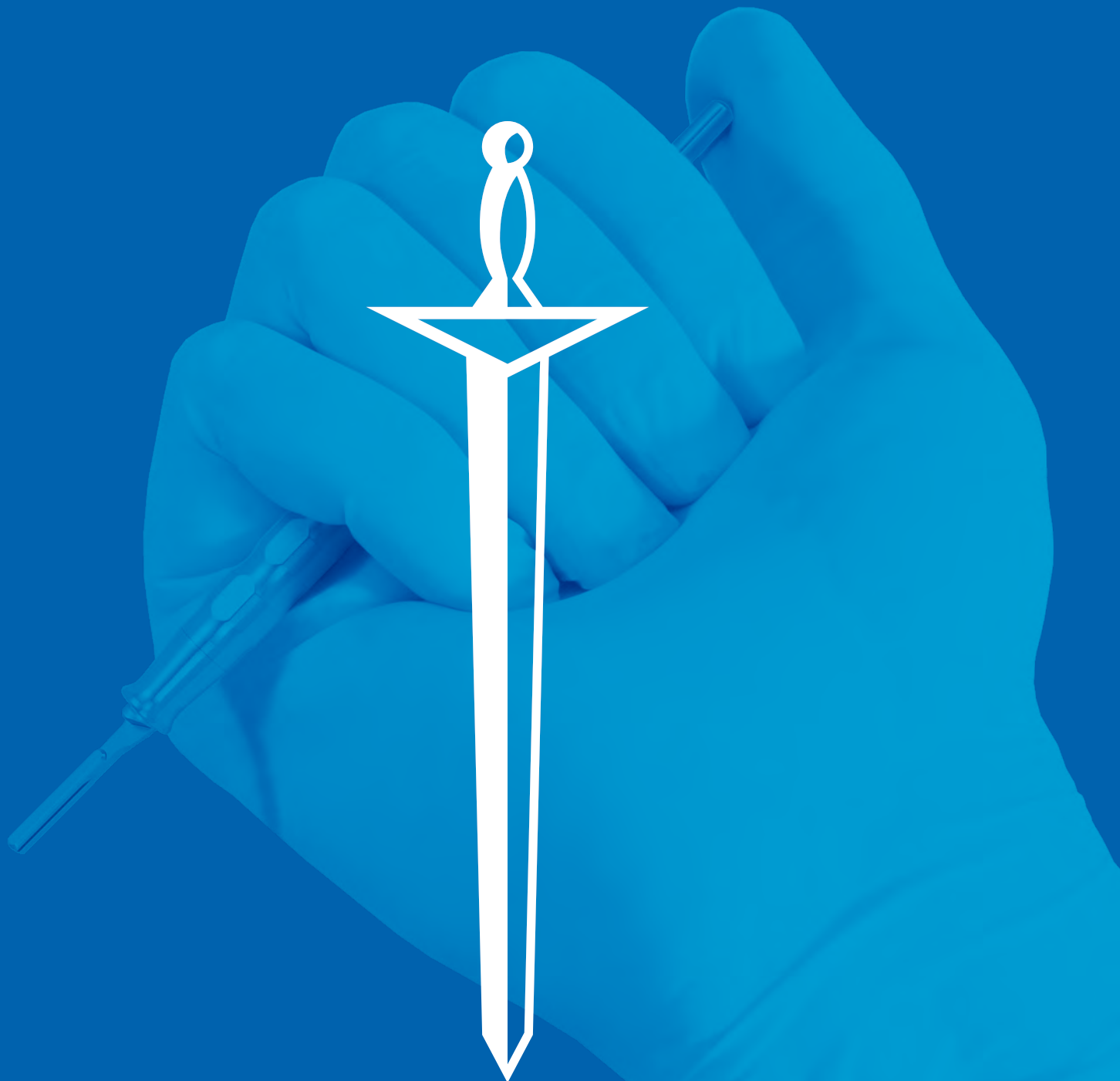

SCHWERT

SWORD · ESPADA
EPEE · SPADA

A. Schweickhardt GmbH & Co. KG

**Hersteller zahnärztlicher und chirurgischer Instrumente
Manufacturer of dental and surgical instruments**

Tuttlinger Straße 12 · 78606 Seitingen-Oberflacht · Germany
Tel.: +49 7464 98910-700 · Fax: +49 7464 98910-719
contact@schwert.com · www.schwert.com

MADE IN GERMANY

schwert.com